

Transistor, N-Channel, Field Effect, Enhancement Mode, 2.5 V Specified

FDT439N

General Description

This N-Channel enhancement mode power field effect transistor is produced using onsemi's proprietary, high cell density, DMOS technology. This very high density process is especially tailored to minimize on-state resistance and provide superior switching performance. These products are well suited to low voltage, low current applications such as notebook computer power management, battery powered circuits, and DC motor control.

Features

- 6.3 A, 30 V
 $R_{DS(on)} = 0.045 \Omega @ V_{GS} = 4.5 \text{ V}$
 $R_{DS(on)} = 0.058 \Omega @ V_{GS} = 2.5 \text{ V}$
- Fast switching speed.
- High power and current handling capability in a widely used surface mount package.
- This Device is Pb-Free

Applications

- DC/DC Converter
- Load Switch
- Motor Driving

ABSOLUTE MAXIMUM RATINGS (T_A = 25°C unless otherwise noted)

Symbol	Parameter	Ratings	Unit	
V _{DSS}	Drain-Source Voltage	30	V	
V _{GSS}	Gate-Source Voltage	±8	V	
I _D	Drain Current	- Continuous (Note 1a)	6.3	A
		- Pulsed	20	
P _D	Power Dissipation for Single Operation	(Note 1a)	3	W
		(Note 1b)	1.3	
		(Note 1c)	1.1	
T _J , T _{stg}	Operating and Storage Junction Temperature Range	-55 to +150	°C	

Stresses exceeding those listed in the Maximum Ratings table may damage the device. If any of these limits are exceeded, device functionality should not be assumed, damage may occur and reliability may be affected.

THERMAL CHARACTERISTICS

Symbol	Parameter	Ratings	Unit
R _{θJA}	Thermal Resistance, Junction-to-Ambient (Note 1a)	42	°C/W
R _{θJC}	Thermal Resistance, Junction-to-Case (Note 1)	12	°C/W

V _{DSS}	R _{DS(ON)} MAX	I _D MAX
30 V	0.045 Ω @ 4.5 V	6.3 A
	0.058 Ω @ 2.5 V	

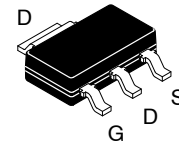

SOT-223
CASE 318H

MARKING DIAGRAM

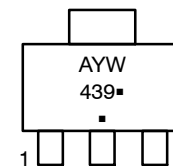

- A = Specific Device Code
- Y = Date Code
- W = Work Week
- 439 = Specific Device Code
- = Pb-Free Package

(Note: Microdot may be in either location)

PINOUT

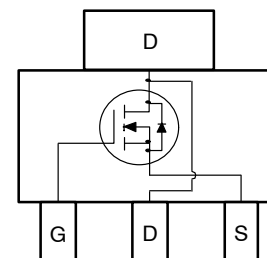

ORDERING INFORMATION

See detailed ordering and shipping information on page 5 of this data sheet.

FDT439N

ELECTRICAL CHARACTERISTICS (T_A = 25°C unless otherwise noted)

Symbol	Parameter	Test Conditions	Min	Typ	Max	Unit
OFF CHARACTERISTICS						
BV _{DSS}	Drain–Source Breakdown Voltage	V _{GS} = 0 V, I _D = 250 μA	30	–	–	V
$\frac{\Delta BV_{DSS}}{\Delta T_J}$	Breakdown Voltage Temperature Coefficient	I _D = 250 μA, Referenced to 25°C	–	40	–	mV/°C
I _{DSS}	Zero Gate Voltage Drain Current	V _{DS} = 24 V, V _{GS} = 0 V	–	–	1	μA
I _{GSSF}	Gate–Body Leakage Current, Forward	V _{GS} = 8 V, V _{DS} = 0 V	–	–	100	nA
I _{GSSR}	Gate–Body Leakage Current, Reverse	V _{GS} = –8 V, V _{DS} = 0 V	–	–	–100	nA

ON CHARACTERISTICS (Note 2)

V _{GS(th)}	Gate Threshold Voltage	V _{DS} = V _{GS} , I _D = 250 μA	0.4	0.67	1	V
$\frac{\Delta V_{GS(th)}}{\Delta T_J}$	Gate Threshold Voltage Temperature Coefficient	I _D = 250 μA, Referenced to 25°C	–	–2.2	–	mV/°C
R _{DS(on)}	Static Drain–Source On–Resistance	V _{GS} = 4.5 V, I _D = 6.3 A V _{GS} = 4.5 V, I _D = 6.3 A, T _J = 125°C V _{GS} = 2.5 V, I _D = 5.5 A	–	0.038 0.055 0.048	0.045 0.072 0.058	Ω
I _{D(on)}	On–State Drain Current	V _{GS} = 4.5 V, V _{DS} = 5 V	10	–	–	A
g _{FS}	Forward Transconductance	V _{DS} = 5 V, I _D = 6.3 A	–	17	–	S

DYNAMIC CHARACTERISTICS

C _{iss}	Input Capacitance	V _{DS} = 15 V, V _{GS} = 0 V, f = 1.0 MHz	–	500	–	pF
C _{oss}	Output Capacitance		–	185	–	pF
C _{rss}	Reverse Transfer Capacitance		–	43	–	pF

SWITCHING CHARACTERISTICS (Note 2)

t _{d(on)}	Turn–On Delay Time	V _{DD} = 15 V, I _D = 1 A, V _{GS} = 4.5 V, R _{GEN} = 6 Ω	–	6	12	ns
t _r	Turn–On Rise Time		–	10	18	ns
t _{d(off)}	Turn–Off Delay Time		–	30	48	ns
t _f	Turn–Off Fall Time		–	10	18	ns
Q _g	Total Gate Charge	V _{DS} = 15 V, I _D = 6.3 A, V _{GS} = 4.5 V	–	10.7	15	nC
Q _{gs}	Gate–Source Charge		–	0.9	–	nC
Q _{gd}	Gate–Drain Charge		–	3.7	–	nC

DRAIN–SOURCE DIODE CHARACTERISTICS AND MAXIMUM RATINGS

I _S	Maximum Continuous Drain–Source Diode Forward Current	–	–	2.5	A	
V _{SD}	Drain–Source Diode Forward Voltage	V _{GS} = 0 V, I _S = 2.5 A (Note 2)	–	0.8	1.2	V

Product parametric performance is indicated in the Electrical Characteristics for the listed test conditions, unless otherwise noted. Product performance may not be indicated by the Electrical Characteristics if operated under different conditions.

NOTES:

- R_{θJA} is the sum of the junction–to–case and case–to–ambient thermal resistance where the case thermal reference is defined as the solder mounting surface of the drain pins. R_{θJC} is guaranteed by design while R_{θCA} is determined by the user's board design.

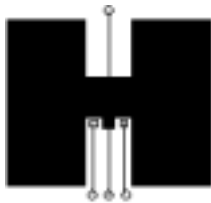

a. 42°C/W when mounted on a 1 in² pad of 2 oz copper.



b. 95°C/W when mounted on a 0.066 in² pad of 2 oz copper.



c. 110°C/W when mounted on a minimum mounting pad.

Scale 1 : 1 on letter size paper

- Pulse Test: Pulse Width ≤ 300 μs, Duty cycle ≤ 2.0 %.

TYPICAL CHARACTERISTICS

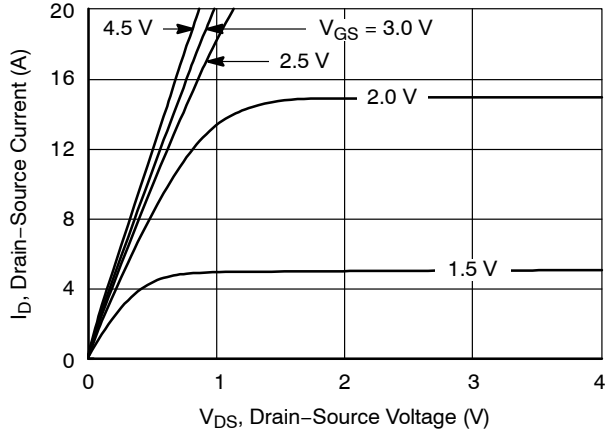

Figure 1. On-Region Characteristics

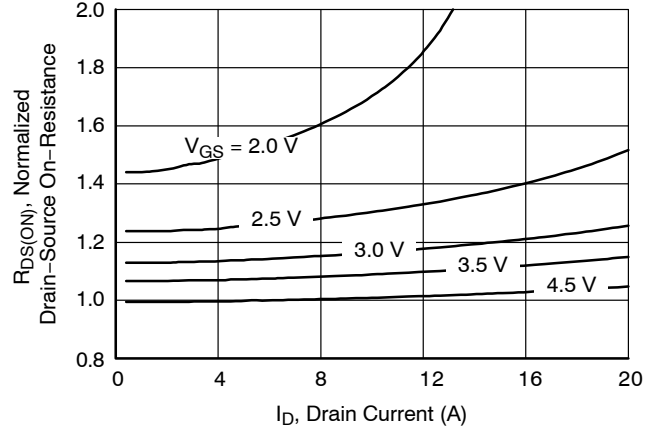

Figure 2. On-Resistance Variation with Drain Current and Gate Voltage

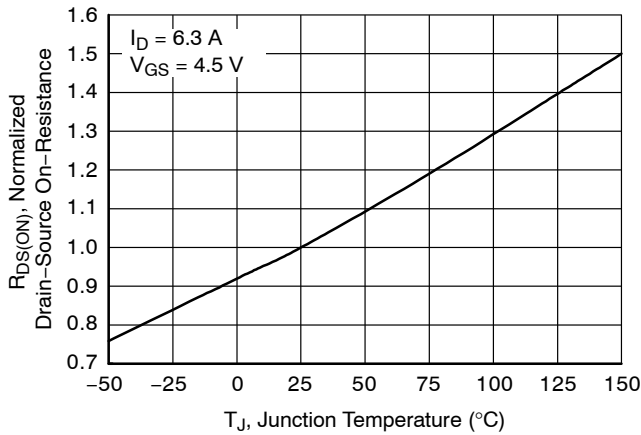

Figure 3. On-Resistance Variation with Temperature

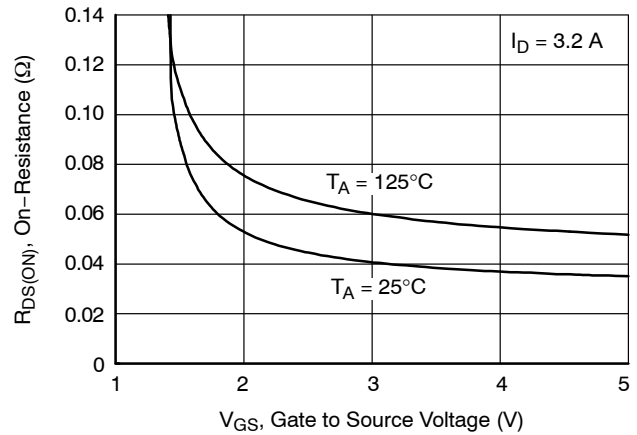

Figure 4. On-Resistance Variation with Gate-to-Source Voltage

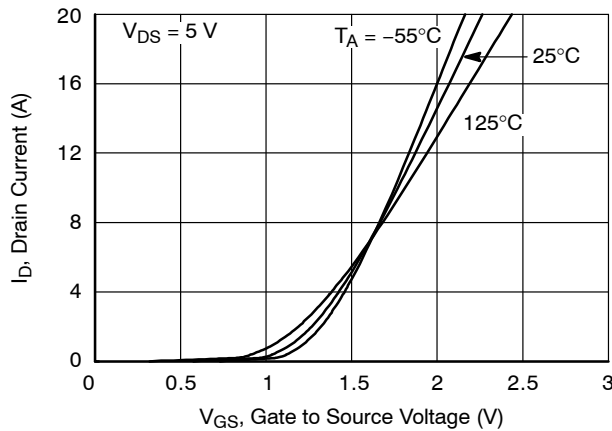

Figure 5. Transfer Characteristics

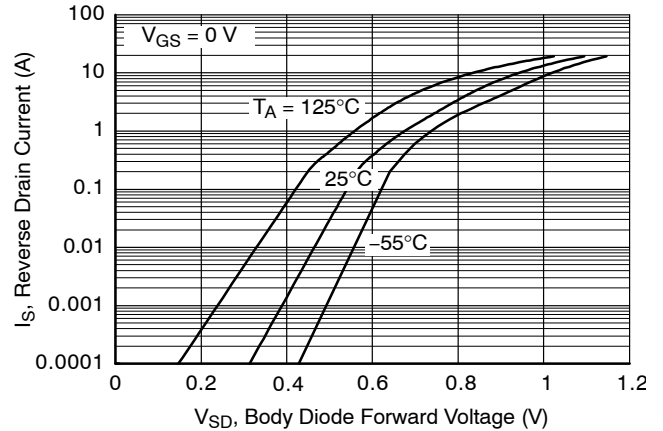

Figure 6. Body Diode Forward Voltage Variation with Source Current and Temperature

TYPICAL ELECTRICAL CHARACTERISTICS (continued)

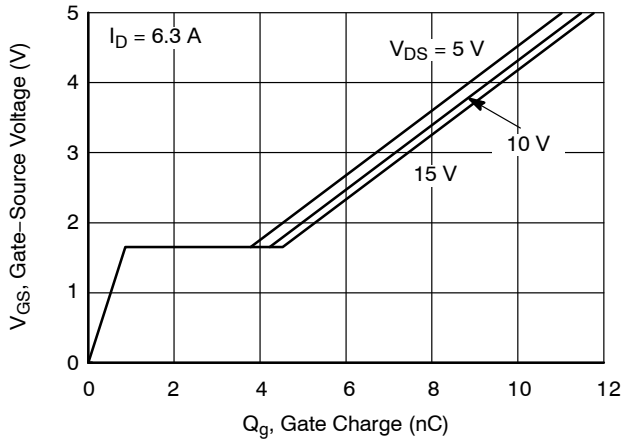

Figure 7. Gate Charge Characteristics

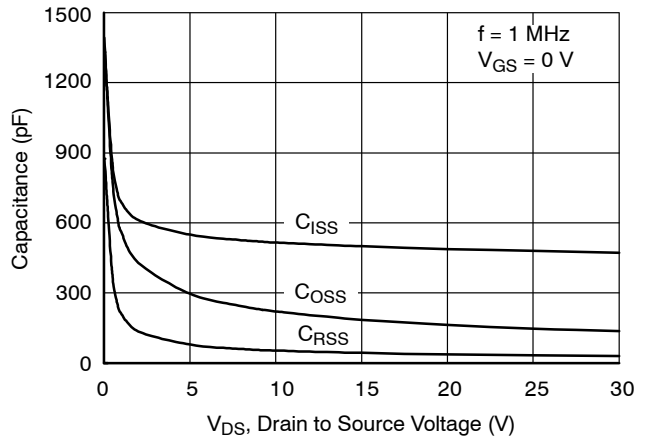

Figure 8. Capacitance Characteristics

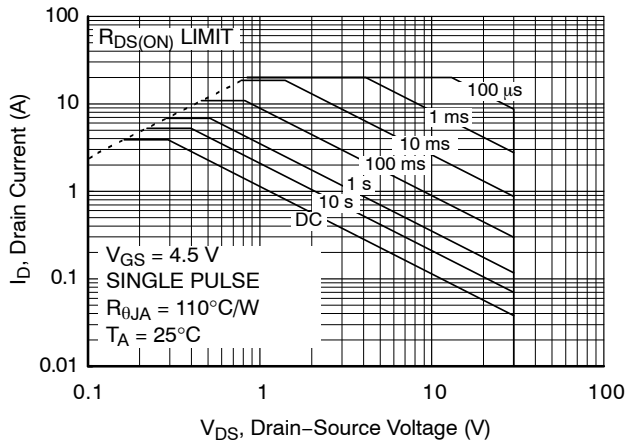

Figure 9. Maximum Safe Operating Area

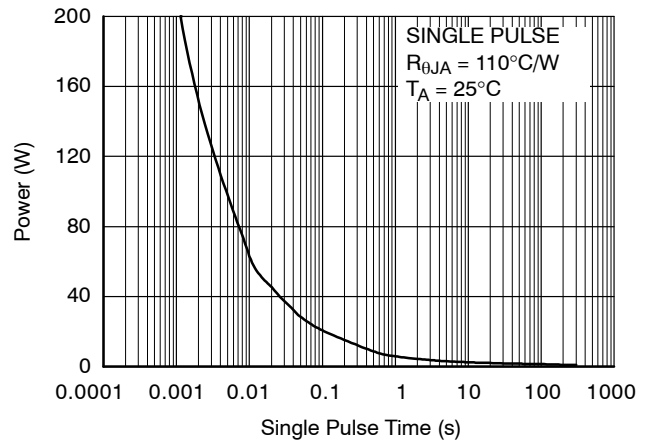

Figure 10. Single Pulse Maximum Power Dissipation

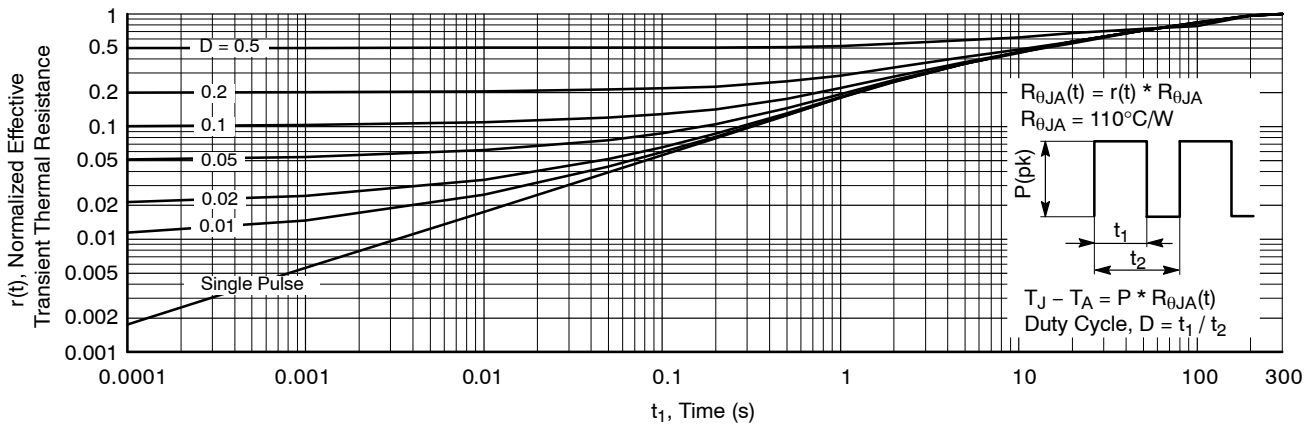

Figure 11. Transient Thermal Response Curve

(Note: Thermal characterization performed using the conditions described in Note 1. Transient thermal response will change depending on the circuit board design.)

FDT439N

ORDERING INFORMATION

Device	Device Marking	Package	Reel Size	Tape Width	Shipping [†]
FDT439N	439	SOT-223 (Pb-free)	13"	12 mm	4000 / Tape & Reel

[†]For information on tape and reel specifications, including part orientation and tape sizes, please refer to our Tape and Reel Packaging Specifications Brochure, BRD8011/D.

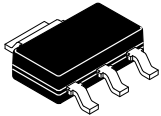

SCALE 2:1

SOT-223
CASE 318H
ISSUE B

DATE 13 MAY 2020

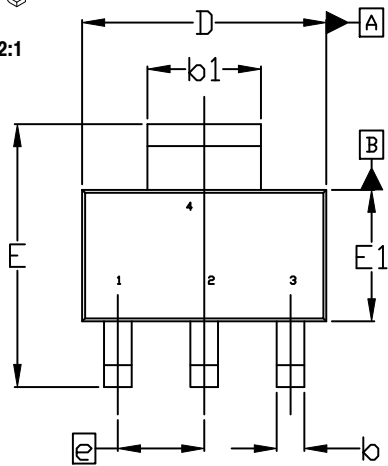

TOP VIEW

$\text{C} \text{ A} \text{ B}$

NOTE 7

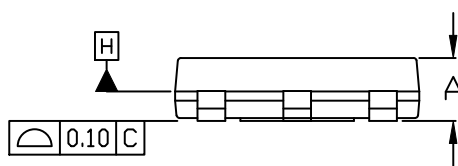

SIDE VIEW

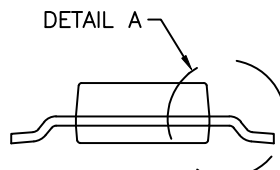

END VIEW

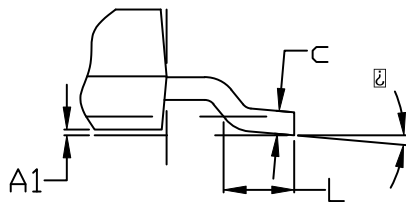

DETAIL A

NOTES:

1. DIMENSIONING AND TOLERANCING PER ASME Y14.5M, 2009.
2. CONTROLLING DIMENSION: MILLIMETERS
3. DIMENSIONS D & E1 ARE DETERMINED AT DATUM H. DIMENSIONS DO NOT INCLUDE MOLD FLASH, PROTRUSIONS OR GATE BURRS. SHALL NOT EXCEED 0.23mm PER SIDE.
4. LEAD DIMENSIONS b AND b1 DO NOT INCLUDE DAMBAR PROTRUSION. ALLOWABLE DAMBAR PROTRUSION IS 0.08mm PER SIDE.
5. DATUMS A AND B ARE DETERMINED AT DATUM H.
6. A1 IS DEFINED AS THE VERTICAL DISTANCE FROM THE SEATING PLANE TO THE LOWEST POINT OF THE PACKAGE BODY.
7. POSITIONAL TOLERANCE APPLIES TO DIMENSIONS b AND b1.

DIM	MILLIMETERS		
	MIN.	NOM.	MAX.
A	---	---	1.80
A1	0.02	0.06	0.11
b	0.60	0.74	0.88
b1	2.90	3.00	3.10
c	0.24	---	0.35
D	6.30	6.50	6.70
E	6.70	7.00	7.30
E1	3.30	3.50	3.70
e	2.30 BSC		
L	0.25	---	---
\square	0°	---	10°

GENERIC MARKING DIAGRAM*

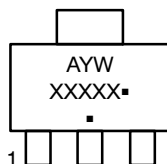

- A = Assembly Location
- Y = Year
- W = Work Week
- XXXXX = Specific Device Code
- = Pb-Free Package

(Note: Microdot may be in either location)

*This information is generic. Please refer to device data sheet for actual part marking. Pb-Free indicator, "G" or microdot "▪", may or may not be present. Some products may not follow the Generic Marking.

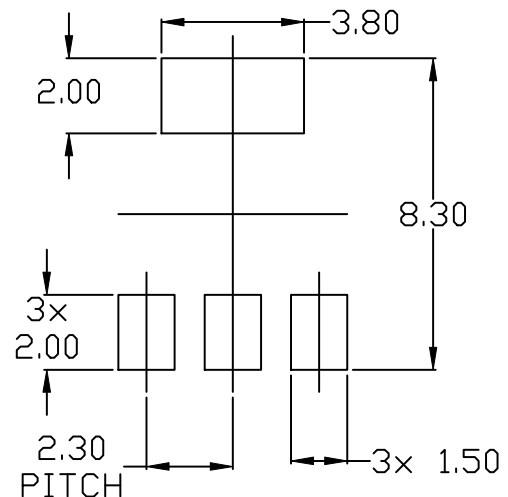

RECOMMENDED MOUNTING FOOTPRINT

* For additional information on our Pb-Free strategy and soldering details, please download the ON Semiconductor Soldering and Mounting Techniques Reference Manual, SOLDERM/D.

DOCUMENT NUMBER:	98ASH70634A	Electronic versions are uncontrolled except when accessed directly from the Document Repository. Printed versions are uncontrolled except when stamped "CONTROLLED COPY" in red.
DESCRIPTION:	SOT-223	PAGE 1 OF 1

onsemi and ONSEMI are trademarks of Semiconductor Components Industries, LLC dba onsemi or its subsidiaries in the United States and/or other countries. onsemi reserves the right to make changes without further notice to any products herein. onsemi makes no warranty, representation or guarantee regarding the suitability of its products for any particular purpose, nor does onsemi assume any liability arising out of the application or use of any product or circuit, and specifically disclaims any and all liability, including without limitation special, consequential or incidental damages. onsemi does not convey any license under its patent rights nor the rights of others.

onsemi, **Onsemi**, and other names, marks, and brands are registered and/or common law trademarks of Semiconductor Components Industries, LLC dba "**onsemi**" or its affiliates and/or subsidiaries in the United States and/or other countries. **onsemi** owns the rights to a number of patents, trademarks, copyrights, trade secrets, and other intellectual property. A listing of **onsemi**'s product/patent coverage may be accessed at www.onsemi.com/site/pdf/Patent-Marking.pdf. **onsemi** reserves the right to make changes at any time to any products or information herein, without notice. The information herein is provided "as-is" and **onsemi** makes no warranty, representation or guarantee regarding the accuracy of the information, product features, availability, functionality, or suitability of its products for any particular purpose, nor does **onsemi** assume any liability arising out of the application or use of any product or circuit, and specifically disclaims any and all liability, including without limitation special, consequential or incidental damages. Buyer is responsible for its products and applications using **onsemi** products, including compliance with all laws, regulations and safety requirements or standards, regardless of any support or applications information provided by **onsemi**. "Typical" parameters which may be provided in **onsemi** data sheets and/or specifications can and do vary in different applications and actual performance may vary over time. All operating parameters, including "Typicals" must be validated for each customer application by customer's technical experts. **onsemi** does not convey any license under any of its intellectual property rights nor the rights of others. **onsemi** products are not designed, intended, or authorized for use as a critical component in life support systems or any FDA Class 3 medical devices or medical devices with a same or similar classification in a foreign jurisdiction or any devices intended for implantation in the human body. Should Buyer purchase or use **onsemi** products for any such unintended or unauthorized application, Buyer shall indemnify and hold **onsemi** and its officers, employees, subsidiaries, affiliates, and distributors harmless against all claims, costs, damages, and expenses, and reasonable attorney fees arising out of, directly or indirectly, any claim of personal injury or death associated with such unintended or unauthorized use, even if such claim alleges that **onsemi** was negligent regarding the design or manufacture of the part. **onsemi** is an Equal Opportunity/Affirmative Action Employer. This literature is subject to all applicable copyright laws and is not for resale in any manner.

ADDITIONAL INFORMATION

TECHNICAL PUBLICATIONS:

Technical Library: www.onsemi.com/design/resources/technical-documentation
onsemi Website: www.onsemi.com

ONLINE SUPPORT: www.onsemi.com/support

For additional information, please contact your local Sales Representative at www.onsemi.com/support/sales