

# TinyBuck<sup>®</sup> Regulator, Digitally Programmable, 5 A, 2.4 MHz

## FAN53200

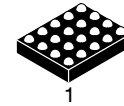

1  
WLCSP-20  
CASE 567SH

### Descriptions

The FAN53200 is a step-down switching voltage regulator that delivers a digitally programmable output from an input voltage supply of 2.5 V to 5.5 V. The output voltage is programmed through an I<sup>2</sup>C interface capable of operating up to 3.4 Mbps.

Using a proprietary architecture with synchronous rectification, the FAN53200 is capable of delivering 5 A continuously at over 80% efficiency, while maintaining over 80% efficiency at load currents as low as 10 mA. The regulator operates at a nominal fixed frequency of 2.4 MHz, which reduces the value of the external components. Additional output capacitance can be added to improve regulation during load transients without affecting stability. Inductance up to 1.2 μH may be used with additional output capacitance.

At moderate and light loads, Pulse Frequency Modulation (PFM) is used to operate in Power-Save Mode with a typical quiescent current of 60 μA. At higher loads, the system automatically switches to fixed-frequency control, operating at 2.4 MHz. In Shutdown Mode, the supply current drops to 0.1 μA, reducing power consumption. PFM Mode can be disabled if constant frequency is desired. The FAN53200 is available in a 20-bump, 1.6 x 2.0 mm, WLCSP.

### Features

- Quiescent Current in PFM Mode: 60 μA (Typical)
- Digitally Programmable Output Voltage:
  - ◆ 0.6 – 1.3875 V in 12.5 mV Steps
- Best-in-Class Load Transient
- Continuous Output Current Capability: 5 A
- 2.5 V to 5.5 V Input Voltage Range
- Programmable Slew Rate for Voltage Transitions
- Fixed-Frequency Operation: 2.4 MHz
- I<sup>2</sup>C-Compatible Interface Up to 3.4 Mbps
- Internal Soft-Start

- Input Under-Voltage Lockout (UVLO)
- Thermal Shutdown and Overload Protection
- 20-Bump Wafer-Level Chip Scale Package (WLCSP)

### Applications

- Graphic, and DSP Processors  
ARM<sup>™</sup>, Krait<sup>™</sup>, OMAP<sup>™</sup>, NovaThor<sup>™</sup>, ARMADA<sup>™</sup>
- Hard Disk Drives
- Tablets, Netbooks, Ultra-Mobile PCs
- Smart Phones
- Gaming Devices

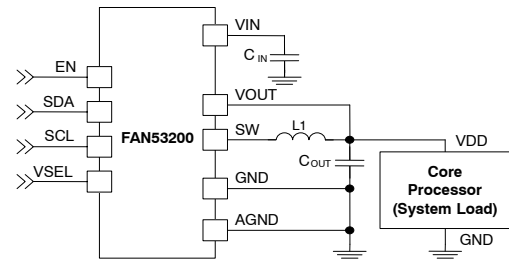

Figure 1. Typical Application

### ORDERING INFORMATION

Part Number	Power-Up Defaults		I <sup>2</sup> C Slave Address	Device ID	Device Marking	Package
	VSEL0	VSEL1				
FAN53200UC35X	OFF	1.15 V	C0	0000	B9	WLCSP-20
FAN53200UC44X	1.15V	0.85 V	C0	0000	CD	WLCSP-20

# FAN53200

## Pin Configuration

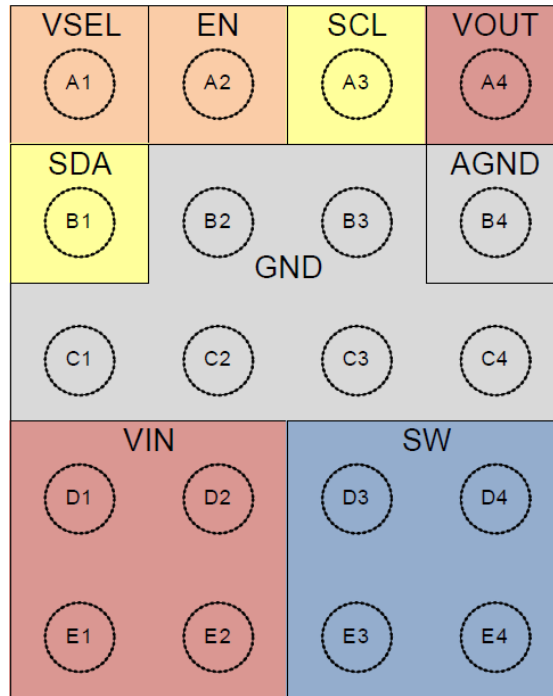

Figure 2. Pin Assignment (Top View)

Table 1. PIN DESCRIPTIONS

Pin #	Name	Description
A1	VSEL	Voltage Select. When this pin is LOW, $V_{OUT}$ is set by the VSEL0 register. When this pin is HIGH, $V_{OUT}$ is set by the VSEL1 register.
A2	EN	Enable. The device is in Shutdown Mode when this pin is LOW. All registers go to default values when EN pin is LOW.
A3	SCL	I <sup>2</sup> C Serial Clock
A4	VOUT	VOUT. Sense pin for VOUT. Connect to $C_{OUT}$ .
B1	SDA	I <sup>2</sup> C Serial Data
B2, B3, C1 – C4	GND	Ground. Low-side MOSFET is referenced to this pin. $C_{IN}$ and $C_{OUT}$ should be returned with a minimal path to these pins.
B4	AGND	Analog Ground. All signals are referenced to this pin. Avoid routing high dV/dt AC currents through this pin.
D1, D2, E1, E2	VIN	Power Input Voltage. Connect to the input power source. Connect to $C_{IN}$ with minimal path.
D3, D4, E3, E4	SW	Switching Node. Connect to the inductor.

# FAN53200

**Table 2. ABSOLUTE MAXIMUM RATINGS**

Symbol	Parameter		Min	Max	Unit
V <sub>IN</sub>	Voltage on SW, VIN Pins	IC Not Switching	-0.3	7.0	V
		IC Switching	-0.3	6.5	
	Voltage on All Other Pins	IC Not Switching	-0.3	V <sub>IN</sub> (Note 1)	V
V <sub>OUT</sub>	Voltage on VOUT Pin		-0.3	3.0	V
V <sub>INOV_SLEW</sub>	Maximum Slew Rate of V <sub>IN</sub> > 6.5 V, PWM Switching			100	V/ms
ESD	Electrostatic Discharge Protection Level	Human Body Model per JESD22-A114	2000		V
		Charged Device Model per JESD22-C101	1000		
T <sub>J</sub>	Junction Temperature		-40	+150	°C
T <sub>STG</sub>	Storage Temperature		-65	+150	°C
T <sub>L</sub>	Lead Soldering Temperature, 10 Seconds			+260	°C

Stresses exceeding those listed in the Maximum Ratings table may damage the device. If any of these limits are exceeded, device functionality should not be assumed, damage may occur and reliability may be affected.

1. Lesser of 7.0 V or V<sub>IN</sub> + 0.3 V

**Table 3. RECOMMENDED OPERATING CONDITIONS**

Symbol	Parameter	Min	Typ	Max	Unit
V <sub>IN</sub>	Supply Voltage Range	2.5		5.5	V
I <sub>OUT</sub>	Output Current	0		5	A
L	Inductor		0.33		μH
C <sub>IN</sub>	Input Capacitor		10		μF
C <sub>OUT</sub>	Output Capacitor		44		μF
T <sub>A</sub>	Operating Ambient Temperature	-40		+85	°C
T <sub>J</sub>	Operating Junction Temperature	-40		+125	°C

Product parametric performance is indicated in the Electrical Characteristics for the listed test conditions, unless otherwise noted. Product performance may not be indicated by the Electrical Characteristics if operated under different conditions.

**Table 4. THERMAL PROPERTIES**

Symbol	Parameter	Min	Typ	Max	Unit
θ <sub>JA</sub>	Junction-to-Ambient Thermal Resistance (Note 2)		38		°C/W

2. See Thermal Considerations in the Application Information section.

# FAN53200

**Table 5. ELECTRICAL CHARACTERISTICS** Minimum and maximum values are at  $V_{IN} = 2.5\text{ V to }5.5\text{ V}$ ,  $T_A = -40^\circ\text{C to }+85^\circ\text{C}$ , unless otherwise noted. Typical values are at  $T_A = 25^\circ\text{C}$ ,  $V_{IN} = 5\text{ V}$ , and  $EN = \text{HIGH}$ .

Symbol	Parameter	Condition	Min	Typ	Max	Unit
--------	-----------	-----------	-----	-----	-----	------

## POWER SUPPLIES

$I_Q$	Quiescent Current	$I_{LOAD} = 0$		60		$\mu\text{A}$
$I_{SD}$	H/W Shutdown Supply Current	$EN = \text{GND}$		0.1	5.0	$\mu\text{A}$
	S/W Shutdown Supply Current	$EN = V_{IN}$ , $\text{BUCK\_ENx} = 0$		41	75	$\mu\text{A}$
$V_{UVLO}$	Under-Voltage Lockout Threshold	$V_{IN}$ Rising		2.35	2.45	V
$V_{UVHYS}$	Under-Voltage Lockout Hysteresis			350		mV

## EN, VSEL, SDA, SCL

$V_{IH}$	high-Level Input Voltage		1.1			V
$V_{IL}$	low-Level Input Voltage				0.4	V
$V_{LHYS}$	Logic Input Hysteresis Voltage			160		mV
$I_{IN}$	Input Bias Current	Input Tied to GND or $V_{IN}$		0.01	1.00	$\mu\text{A}$

## PGOOD

$I_{OUTL}$	PGOOD Pull-Down Current				1	mA
$I_{OUTH}$	PGOOD HIGH Leakage Current			0.01	1.00	$\mu\text{A}$

## V<sub>OUT</sub> REGULATION

$V_{REG}$	$V_{OUT}$ DC Accuracy	$I_{OUT(DC)} = 0$ , Forced PWM, $V_{OUT} = \text{VSEL1}$ Default Value, $2.5\text{ V} \leq V_{IN} \leq 5.5\text{ V}$	-1.5		1.5	%
		$I_{OUT(DC)} = 0$ to 5 A, $V_{OUT} = \text{VSEL1}$ , Default Value, Auto PFM/PWM, $2.5\text{ V} \leq V_{IN} \leq 4.5\text{ V}$	-2.0		4.0	%
		$I_{OUT(DC)} = 0$ to 5 A, $V_{OUT} = \text{VSEL1}$ , Default Value, Auto PFM/PWM, $2.5\text{ V} \leq V_{IN} \leq 5.5\text{ V}$	-3.0		5.0	%

## POWER SWITCH AND PROTECTION

$I_{LIMP}$	P-MOS Peak Current Limit	Open Loop	6.3	7.4	8.5	A
$V_{SDWN}$	Input OVP Shutdown	Rising Threshold		6.15		V
		Falling Threshold	5.50	5.85		V

## FREQUENCY CONTROL

$f_{SW}$	Oscillator Frequency		2.05	2.40	2.75	MHz
$R_{OFF}$	$V_{OUT}$ Pull-Down Resistance	$EN = 0$ or $V_{IN} < V_{UVLO}$		160		$\Omega$

Product parametric performance is indicated in the Electrical Characteristics for the listed test conditions, unless otherwise noted. Product performance may not be indicated by the Electrical Characteristics if operated under different conditions.

**Table 6. SYSTEM CHARACTERISTICS**

Symbol	Parameter	Condition	Min	Typ	Max	Unit
$\Delta V_{OUT\_LOAD}$	Load Regulation	$I_{OUT} = 1\text{ A to }5\text{ A}$		0.2		mV/A
$\Delta V_{OUT\_LINE}$	Line Regulation	$3.6\text{ V} \leq V_{IN} \leq 4.0\text{ V}$ , $I_{OUT} = 3\text{ A}$		-0.5		mV/V
$V_{OUT\_RIPPLE}$	Ripple Voltage	$I_{OUT} = 100\text{ mA}$ , PFM Mode		16		mV
		$I_{OUT} = 2000\text{ mA}$ , PWM Mode		3		
$\eta$	Efficiency	$V_{OUT} = 1.15\text{ V}$ , $I_{OUT} = 100\text{ mA}$		87		%
		$V_{OUT} = 1.15\text{ V}$ , $I_{OUT} = 500\text{ mA}$		88		
		$V_{OUT} = 1.15\text{ V}$ , $I_{OUT} = 2\text{ A}$		88		
$T_{SS}$	Soft-Start	$EN$ High to 95% of $V_{OUT}$ Target (1.15 V) $R_{LOAD} = 50\ \Omega$		340		$\mu\text{s}$
$\Delta V_{OUT\_LOAD\_TRAN}$	Load Transient	$I_{OUT} = 0.1\text{ A} \leftrightarrow 1.2\text{ A}$ , $T_R = T_F = 100\text{ ns}$		$\pm 20$		mV
$\Delta V_{OUT\_LINE\_TRAN}$	Line Transient	$V_{IN} = 3.0\text{ V} \leftrightarrow 3.6\text{ V}$ , $T_R = T_F = 10\ \mu\text{s}$ , $I_{OUT} = 500\text{ mA}$		$\pm 20$		mV

NOTE: The table above is verified by design and bench test while using the following external components:  $L = 0.33\ \mu\text{H}$ , DFE252012F-R33M (TOKO),  $C_{IN} = 10\ \mu\text{F}$ , C2012X5R1A106M (TDK),  $C_{OUT} = 2 \times 22\ \mu\text{F}$ , C2012X5R0J226M (TDK). **These parameters are not tested in production.** Minimum and maximum values are at  $V_{IN} = 2.5\text{ V to }5.5\text{ V}$ ,  $V_{EN} = 1.8\text{ V}$ ,  $T_A = -40^\circ\text{C to }+85^\circ\text{C}$ ; circuit of Figure 1, unless otherwise noted. Typical values are at  $T_A = 25^\circ\text{C}$ ,  $V_{IN} = 3.6\text{ V}$ ,  $V_{OUT} = 1.15\text{ V}$ ,  $V_{EN} = 1.8\text{ V}$ , Auto PFM Mode.

## Typical Characteristics

Unless otherwise specified,  $V_{IN} = 3.6\text{ V}$ ,  $V_{OUT} = 1.15\text{ V}$ ,  $V_{EN} = 1.8\text{ V}$ , Auto PFM Mode,  $T_A = 25^\circ\text{C}$ ; circuit and components according to Figure 1.

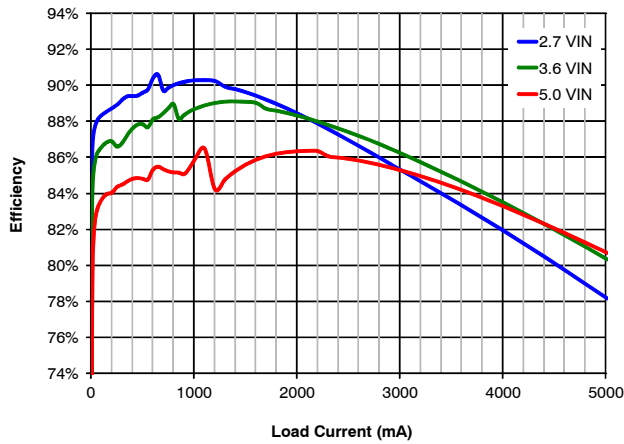

**Figure 3. Efficiency vs. Load Current and Input Voltage**

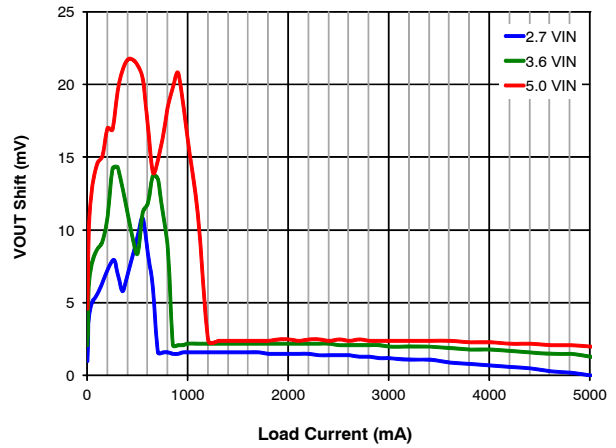

**Figure 4. Output Regulation vs. Load Current and Input Voltage**

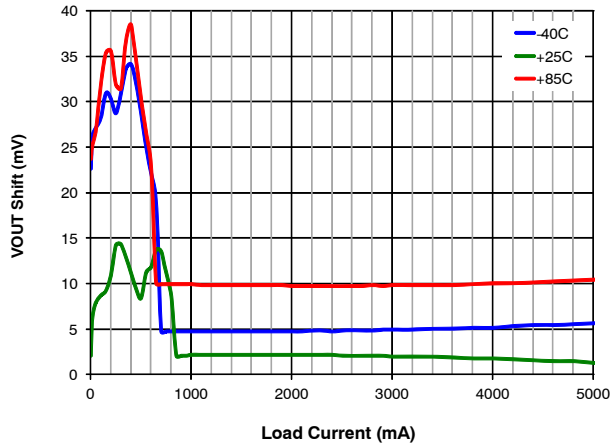

**Figure 5. Output Regulation vs. Load Current, Over-Temperature**

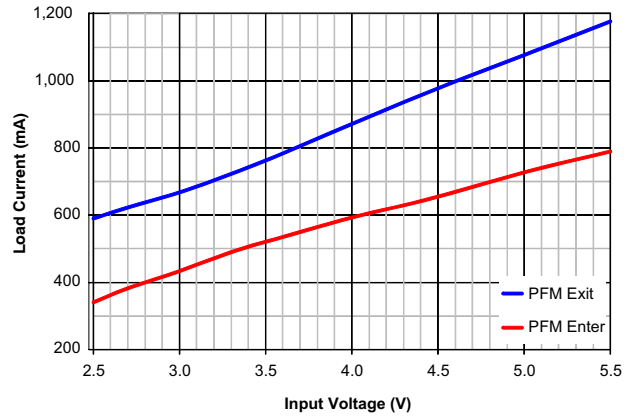

**Figure 6. PFM Entry / Exit Level vs. Input Voltage**

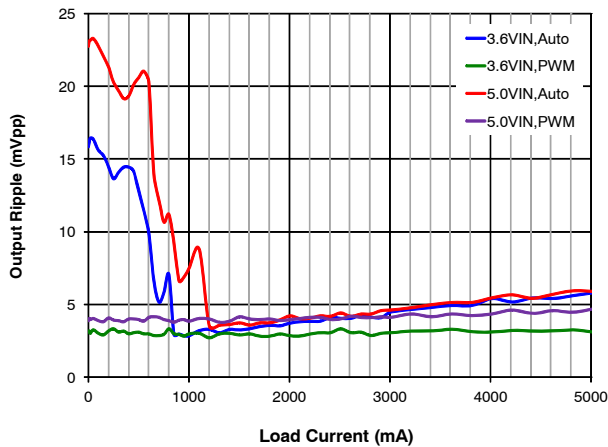

**Figure 7. Output Ripple vs. Load Current**

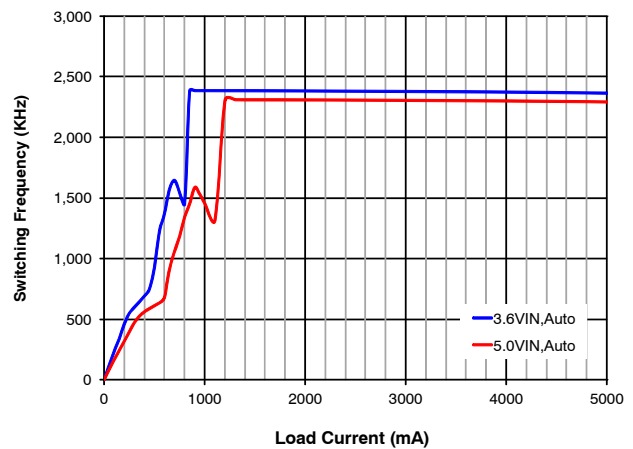

**Figure 8. Frequency vs. Load Current**

# FAN53200

## Typical Characteristics

Unless otherwise specified,  $V_{IN} = 3.6\text{ V}$ ,  $V_{OUT} = 1.15\text{ V}$ ,  $V_{EN} = 1.8\text{ V}$ , Auto PFM Mode,  $T_A = 25^\circ\text{C}$ ; circuit and components according to Figure 1.

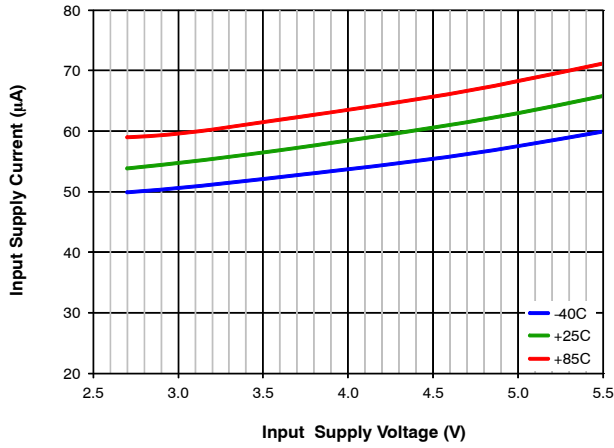

Figure 9. Quiescent Current vs. Input Voltage, Over-Temperature

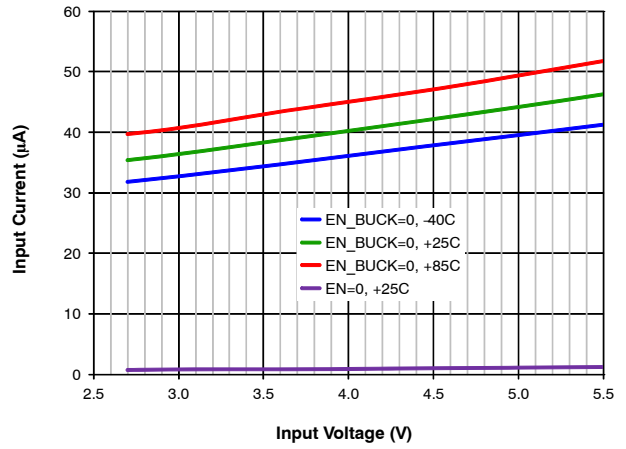

Figure 10. Shutdown Current vs. Input Voltage, Over-Temperature

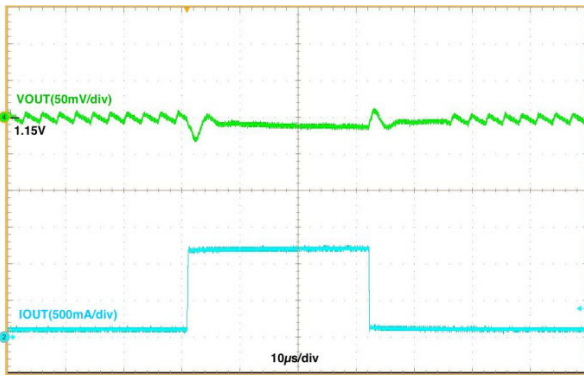

Figure 11. Load Transient,  $I_{OUT} = 0.1\text{ A} \leftrightarrow 1.2\text{ A}$ , Auto PFM Mode,  $T_R = T_F = 100\text{ ns}$

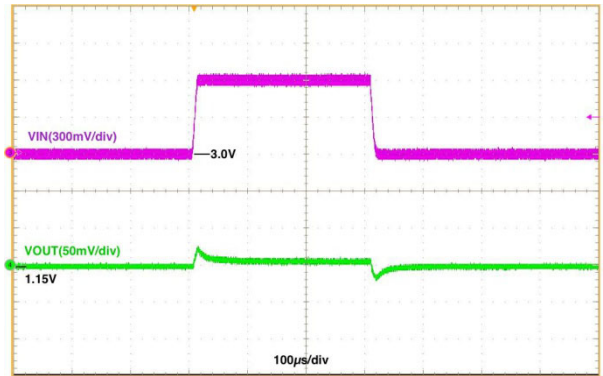

Figure 12. Line Transient,  $V_{IN} = 3.0\text{ V} \leftrightarrow 3.6\text{ V}$ ,  $T_R = T_F = 10\text{ }\mu\text{s}$ ,  $I_{OUT} = 500\text{ mA}$

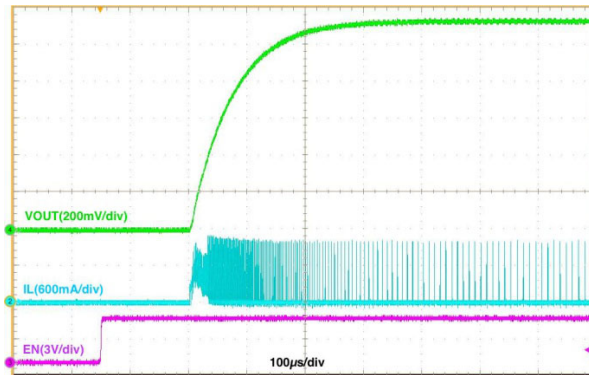

Figure 13. Startup,  $R_{load} = 50\text{ }\Omega$

**Operation Description**

The FAN53200 is a step-down switching voltage regulator that delivers a programmable output voltage from an input voltage supply of 2.5 V to 5.5 V. Using a proprietary architecture with synchronous rectification, the FAN53200 is capable of delivering 5 A at over 80% efficiency. The regulator operates at a nominal frequency of 2.4 MHz at full load, which reduces the value of the external components to 330 nH for the output inductor and 44 μF for the output capacitor. High efficiency is maintained at light load with single-pulse PFM.

The FAN53200 integrates an I<sup>2</sup>C-compatible interface, allowing transfers up to 3.4 Mbps. This communication interface can be used to:

- Dynamically re-program the output voltage in 12.5 mV steps;
- Reprogram the mode to enable or disable PFM;
- Control voltage transition slew rate; or
- Enable / disable the regulator.

**Control Scheme**

The FAN53200 uses a proprietary non-linear, fixed-frequency PWM modulator to deliver a fast load transient response, while maintaining a constant switching frequency over a wide range of operating conditions. The regulator performance is independent of the output capacitor ESR, allowing for the use of ceramic output capacitors. Although this type of operation normally results in a switching frequency that varies with input voltage and load current, an internal frequency loop holds the switching frequency constant over a large range of input voltages and load currents.

For very light loads, the FAN53200 operates in Discontinuous Conduction Mode (DCM) single-pulse PFM, which produces low output ripple compared with other PFM architectures. Transition between PWM and PFM is relatively seamless, providing a smooth transition between DCM and Continuous Conduction Mode (CCM).

PFM can be disabled by programming the MODE bit HIGH in the VSEL registers.

**Enable and Soft-Start**

When the EN pin is LOW; the IC is shut down, all internal circuits are off, and the part draws very little current. In this state, I<sup>2</sup>C cannot be written to or read from. All registers are reset to default values when EN pin is LOW.

When the OUTPUT\_DISCHARGE bit in the CONTROL register is enabled (logic HIGH) and the EN pin is LOW or the BUCK\_ENx bit is LOW, a load is connected from VOUT to GND to discharge the output capacitors.

Raising EN while the BUCK\_ENx bit is HIGH activates the part and begins the soft-start cycle. During soft-start, the modulator’s internal reference is ramped slowly to minimize surge currents on the input and prevent overshoot of the output voltage. Synchronous rectification is inhibited during soft-start, allowing the IC to start into a pre-charged capacitive load.

If large output capacitance values are used, the regulator may fail to start. Maximum C<sub>OUT</sub> capacitance for successfully starting with a heavy constant-current load is approximately:

$$C_{OUTMAX} \approx (I_{LIMPK} - I_{LOAD}) \cdot \frac{320 \mu}{V_{OUT}} \quad (\text{eq. 1})$$

where C<sub>OUTMAX</sub> is expressed in μF and I<sub>LOAD</sub> is the load current during soft-start, expressed in A.

If the regulator is at its current limit for 16 consecutive current limit cycles, the regulator shuts down and enters tri-state before reattempting soft-start 1700 μs later. This limits the duty cycle of full output current during soft-start to prevent excessive heating.

The IC allows for software enable of the regulator, when EN is HIGH, through the BUCK\_EN bits. Only BUCK\_EN1 is initialized HIGH.

**Table 7. HARDWARE AND SOFTWARE ENABLE**

Pins		Bits		Output Voltage	
EN	VSEL	BUCK_EN0	BUCK_EN1	35X	44X
0	X	X	X	OFF	OFF
1	0	0	X	0 V	0 V
1	0	1	X	1.1 V	1.15 V
1	1	X	0	0 V	0 V
1	1	X	1	1.15 V	0.85 V

**VSEL Pin and I<sup>2</sup>C Programming Output Voltage**

The output voltage is set by the NSELx control bits in VSEL0 and VSEL1 registers. The output voltage is given as:

$$V_{OUT} = 0.60 \text{ V} + \text{NSELx} \cdot 12.5 \text{ mV} \quad (\text{eq. 2})$$

Output voltage can also be controlled by toggling the VSEL pin LOW or HIGH. VSEL LOW corresponds to VSEL0 and VSEL HIGH corresponds to VSEL1. Upon POR, VSEL0 and VSEL1 are reset to their default voltages, shown in Table 11.

**Transition Slew Rate Limiting**

When transitioning from a low to high voltage, the IC can be programmed for one of eight possible slew rates using the SLEW bits in the CONTROL register (Table 12).

**Table 8. TRANSITION SLEW RATE**

Decimal	Bin	Slew Rate	
0	000	80	mV / μs
1	001	40	mV / μs
2	010	20	mV / μs
3	011	10	mV / μs
4	100	5	mV / μs
5	101	2.5	mV / μs
6	110	1.25	mV / μs
7	111	0.625	mV / μs

Transitions from high to low voltage rely on the output load to discharge  $V_{OUT}$  to the new set point. Once the high-to-low transition begins, the IC stops switching until  $V_{OUT}$  has reached the new set point.

**Under-Voltage Lockout (UVLO)**

When EN is HIGH, the under-voltage lockout keeps the part from operating until the input supply voltage raises high enough to properly operate. This ensures proper operation of the regulator during startup or shutdown.

**Input Over-Voltage Protection (OVP)**

When  $V_{IN}$  exceeds  $V_{SDWN}$  (about 6.2 V) the IC stops switching to protect the circuitry from internal spikes above 6.5 V. An internal filter prevents the circuit from shutting down due to noise spikes.

**Current Limiting**

A heavy load or short circuit on the output causes the current in the inductor to increase until a maximum current threshold is reached in the high-side switch. Upon reaching this point, the high-side switch turns off, preventing high currents from causing damage. Sixteen consecutive current limit cycles in current limit cause the regulator to shut down and stay off for about 1700  $\mu$ s before attempting a restart.

**Thermal Shutdown**

When the die temperature increases, due to a high load condition and/or high ambient temperature, the output switching is disabled until the die temperature falls sufficiently. The junction temperature at which the thermal shutdown activates is nominally 150°C with a 17°C hysteresis.

**I<sup>2</sup>C Interface**

The FAN53200’s serial interface is compatible with Standard, Fast, Fast Plus, and HS Mode I<sup>2</sup>C-Bus<sup>®</sup> specifications. The FAN53200’s SCL line is an input and its SDA line is a bi-directional open-drain output; it can only pull down the bus when active. The SDA line only pulls LOW during data reads and when signaling ACK. All data is shifted in MSB (bit 7) first.

**I<sup>2</sup>C Slave Address**

In hex notation, the slave address assumes a 0 LS Bit. The hex slave address is C0.

**Table 9. I<sup>2</sup>C SLAVE ADDRESS**

Hex	Bits							
	7	6	5	4	3	2	1	0
C0	1	1	0	0	0	0	0	R/W

Other slave addresses can be assigned. Contact an onsemi representative.

**Bus Timing**

As shown in Figure 14, data is normally transferred when SCL is LOW. Data is clocked in on the rising edge of SCL. Typically, data transitions shortly at or after the falling edge

of SCL to allow ample time for the data to set up before the next SCL rising edge.

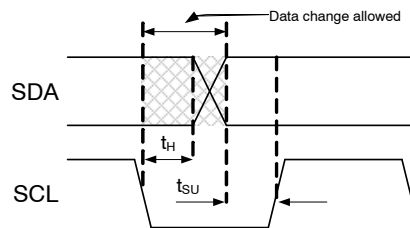

**Figure 14. Data Transfer Timing**

Each bus transaction begins and ends with SDA and SCL HIGH. A transaction begins with a START condition, which is defined as SDA transitioning from 1 to 0 with SCL high, as shown in Figure 15.

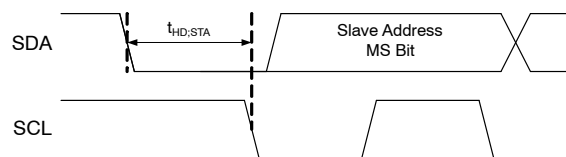

**Figure 15. START Bit**

A transaction ends with a STOP condition, which is defined as SDA transitioning from 0 to 1 with SCL high, as shown in Figure 16.

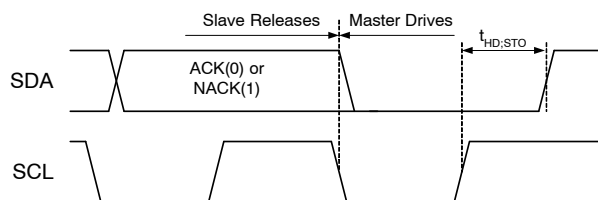

**Figure 16. STOP Bit**

During a read from the FAN53200, the master issues a REPEATED START after sending the register address, and before resending the slave address. The REPEATED START is a 1 to 0 transition on SDA while SCL is HIGH, as shown in Figure 17.

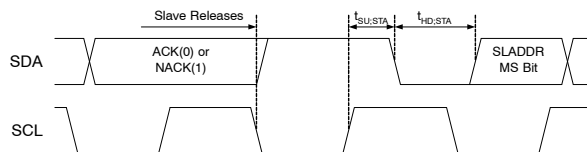

**Figure 17. REPEATED START Timing**

**High-Speed (HS) Mode**

The protocols for High-Speed (HS), Low-Speed (LS), and Fast-Speed (FS) Modes are identical, except the bus speed for HS mode is 3.4 MHz. HS Mode is entered when the bus master sends the HS master code 00001XXX after a START condition. The master code is sent in Fast or Fast-Plus Mode (less than 1 MHz clock); slaves do not ACK this transmission.

# FAN53200

The master generates a REPEATED START condition that causes all slaves on the bus to switch to HS Mode. The master then sends I<sup>2</sup>C packets, as described above, using the HS Mode clock rate and timing.

The bus remains in HS Mode until a STOP bit (Figure 16) is sent by the master. While in HS Mode, packets are separated by REPEATED START conditions (Figure 17).

## Read and Write Transactions

The following figures outline the sequences for data read and write. Bus control is signified by the shading of the packet, defined as

Master Drives Bus

and

Slave Drives Bus

All addresses and data are MSB first.

**Table 10. I<sup>2</sup>C BIT DEFINITIONS for Figure 18 & Figure 19**

Symbol	Definition
S	START, see Figure 15
A	ACK. The slave drives SDA to 0 to acknowledge the preceding packet.
$\bar{A}$	NACK. The slave sends a 1 to NACK the preceding packet.
R	Repeated START, see Figure 17
P	STOP, see Figure 16

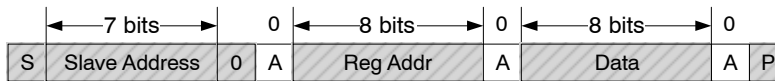

**Figure 18. Write Transaction**



**Figure 19. Read Transaction**

## Register Description

**Table 11. REGISTER MAP**

Hex Address	Name	Function
00	VSEL0	Controls V <sub>OUT</sub> settings when VSEL pin = 0
01	VSEL1	Controls V <sub>OUT</sub> settings when VSEL pin = 1
02	CONTROL	Determines whether V <sub>OUT</sub> output discharge is enabled and also the slew rate of positive transitions
03	ID1	Read-only register identifies vendor and chip type
04	ID2	Read-only register identifies die revision
05	MONITOR	Indicates device status

## FAN53200

The following table defines the operation of each register bit.

**Table 12. BIT DEFINITIONS**

Bit	Name	35X	44X	Description
<b>VSEL0</b>		<b>R/W</b>		<b>Register Address: 00</b>
7	BUCK_EN0	0	1	Software buck enable. When EN pin is LOW, the regulator is off. When EN pin is HIGH, BUCK_EN bit takes precedent.
6	MODE0	0	0	0: Allow Auto PFM Mode during light load. 1: Forced PWM Mode.
5:0	NSEL0	101000	101100	Sets $V_{OUT}$ value from 0.6V to 1.3875 V in 12.5 mV steps (see Equation 2).
<b>VSEL1</b>		<b>R/W</b>		<b>Register Address: 01</b>
7	BUCK_EN1	1	1	Software buck enable. When EN pin is LOW, the regulator is off. When EN pin is HIGH, BUCK_EN bit takes precedent.
6	MODE1	0	0	0: Allow Auto PFM Mode during light load. 1: Forced PWM Mode.
5:0	NSEL1	101100	010100	Sets $V_{OUT}$ value from 0.6V to 1.3875 V in 12.5 mV steps (see Equation 2).
<b>CONTROL</b>		<b>R/W</b>		<b>Register Address: 02</b>
7	OUTPUT_DISCHARGE	1	0	0: When the regulator is turned off, $V_{OUT}$ is not discharged. 1: When the regulator is turned off, $V_{OUT}$ discharges through an internal pull-down.
6:4	SLEW	000	000	Sets the slew rate for positive voltage transitions (see Table 8).
3	Reserved	0	0	Always reads back 0
2	RESET Reserved	0	0	1: Reset all registers to default values. 0: Always reads back 0
1:0	Reserved	00	00	Always reads back 00
<b>ID1</b>		<b>R</b>		<b>Register Address: 03</b>
7:5	VENDOR	100		Signifies <b>onsemi</b> as the IC vendor
4	Reserved	0		Always reads back 0
3:0	DIE_ID	0000		Refer to ordering information
<b>ID2</b>		<b>R</b>		<b>Register Address: 04</b>
7:4	Reserved	0000		Always reads back 0000
3:0	DIE_REV	0001	0000	IC mask revision
<b>MONITOR</b>		<b>R</b>		<b>Register Address: 05</b>
7	PGOOD	1		1: buck is enabled and soft-start is completed
6:0	Not used	0000000		Always reads back 000 0000

Application Information

Selecting the Inductor

The output inductor must meet both the required inductance and the energy-handling capability of the application. The inductor value affects the average current limit, the output voltage ripple, and the efficiency.

The ripple current ( $\Delta I$ ) of the regulator is:

$$\Delta I \approx \frac{V_{OUT}}{V_{IN}} \cdot \left( \frac{V_{IN} - V_{OUT}}{L \cdot f_{SW}} \right) \quad (\text{eq. 3})$$

The maximum average load current,  $I_{MAX(LOAD)}$ , is related to the peak current limit,  $I_{LIM(PK)}$  by the ripple current such that:

$$I_{MAX(LOAD)} = I_{LIM(PK)} - \frac{\Delta I}{2} \quad (\text{eq. 4})$$

The FAN53200 is optimized for operation with  $L = 330 \text{ nH}$ , but is stable with inductances up to  $1.0 \text{ }\mu\text{H}$  (nominal). The inductor should be rated to maintain at least 80% of its value at  $I_{LIM(PK)}$ . Failure to do so lowers the amount of DC current the IC can deliver.

Efficiency is affected by the inductor DCR and inductance value. Decreasing the inductor value for a given physical size typically decreases the DCR; but since  $\Delta I$  increases, the RMS current increases, as do core and skin-effect losses.

$$I_{RMS} = \sqrt{I_{OUT(DC)}^2 + \frac{\Delta I^2}{12}} \quad (\text{eq. 5})$$

The increased RMS current produces higher losses through the  $R_{DS(ON)}$  of the IC MOSFETs as well as the inductor ESR.

Increasing the inductor value produces lower RMS currents, but degrades transient response. For a given physical inductor size, increased inductance usually results in an inductor with lower saturation current.

**Table 13. EFFECTS OF INDUCTOR VALUE (from 330 nH Recommended) on Regulator Performance**

$I_{MAX(LOAD)}$	$\Delta V_{OUT}$ (Equation 7)	Transient Response
Increase	Decrease	Degraded

Inductor Current Rating

The current limit circuit can allow substantial peak currents to flow through  $L1$  under worst-case conditions. If it is possible for the load to draw such currents, the inductor should be capable of sustaining the current or failing in a safe manner.

For space-constrained applications, a lower current rating for  $L1$  can be used. The FAN53200 may still protect these inductors in the event of a short circuit, but may not be able to protect the inductor from failure if the load is able to draw higher currents than the DC rating of the inductor.

Output Capacitor and  $V_{OUT}$  Ripple

Table 14 suggests 0805 capacitors, but 0603 capacitors may be used if space is at a premium. Due to voltage effects, the 0603 capacitors have a lower in-circuit capacitance than the 0805 package, which can degrade transient response and output ripple.

Increasing  $C_{OUT}$  has negligible effect on loop stability and can be increased to reduce output voltage ripple or to improve transient response. Output voltage ripple,  $\Delta V_{OUT}$ , is calculated by:

$$\Delta V_{OUT} = \Delta I_L \left[ \frac{f_{SW} \cdot C_{OUT} \cdot ESR^2}{2 \cdot D \cdot (1 - D)} + \frac{1}{8 \cdot f_{SW} \cdot C_{OUT}} \right] \quad (\text{eq. 6})$$

where  $C_{OUT}$  is the effective output capacitance.

The capacitance of  $C_{OUT}$  decreases at higher output voltages, which results in higher  $\Delta V_{OUT}$ . Equation 6 is only valid for Continuous Current Mode (CCM) operation, which occurs when the regulator is in PWM Mode.

For large  $C_{OUT}$  values, the regulator may fail to start under a load. If an inductor value greater than  $1.0 \text{ }\mu\text{H}$  is used, at least  $30 \text{ }\mu\text{F}$  of  $C_{OUT}$  should be used to ensure stability.

The lowest  $\Delta V_{OUT}$  is obtained when the IC is in PWM Mode and, therefore, operating at  $2.4 \text{ MHz}$ . In PFM Mode,  $f_{SW}$  is reduced, causing  $\Delta V_{OUT}$  to increase.

ESL Effects

The Equivalent Series Inductance (ESL) of the output capacitor network should be kept low to minimize the square-wave component of output ripple that results from the division ratio  $C_{OUT}$  ESL and the output inductor ( $L_{OUT}$ ). The square-wave component due to the ESL can be estimated as:

$$\Delta V_{OUT(SQ)} \approx V_{IN} \cdot \frac{ESL_{COUT}}{L1} \quad (\text{eq. 7})$$

A good practice to minimize this ripple is to use multiple output capacitors to achieve the desired  $C_{OUT}$  value. For example, to obtain  $C_{OUT} = 20 \text{ }\mu\text{F}$ , a single  $22 \text{ }\mu\text{F}$  0805 would produce twice the square wave ripple as two  $10 \text{ }\mu\text{F}$  0805.

To minimize ESL, try to use capacitors with the lowest ratio of length to width. 0805s have lower ESL than 1206s. If low output ripple is a chief concern, some vendors produce 0508 or 0612 capacitors with ultra-low ESL. Placing additional small-value capacitors near the load also reduces the high-frequency ripple components.

Input Capacitor

The ceramic input capacitors should be placed as close as possible between the  $V_{IN}$  pin and  $PGND$  to minimize the parasitic inductance. If a long wire is used to bring power to the IC, additional “bulk” capacitance (electrolytic or tantalum) should be placed between  $C_{IN}$  and the power source lead to reduce under-damped ringing that can occur between the inductance of the power source leads and  $C_{IN}$ .

## FAN53200

The effective  $C_{IN}$  capacitance value decreases as  $V_{IN}$  increases due to DC bias effects. This has no significant impact on regulator performance.

### Thermal Considerations

Heat is removed from the IC through the solder bumps to the PCB copper. The junction-to-ambient thermal resistance ( $\theta_{JA}$ ) is largely a function of the PCB layout (size, copper weight, and trace width) and the temperature rise from junction to ambient ( $\Delta T$ ).

For the FAN53200UC,  $\theta_{JA}$  is 38°C/W when mounted on its four-layer evaluation board in still air with two-ounce outer layer copper weight and one-ounce inner layers. Halving the copper thickness results in an increased  $\theta_{JA}$  of 48°C/W.

For long-term reliable operation, the IC's junction temperature ( $T_j$ ) should be maintained below 125°C.

To calculate maximum operating temperature ( $\leq 125^\circ\text{C}$ ) for a specific application:

1. Use efficiency graphs to determine efficiency for the desired  $V_{IN}$ ,  $V_{OUT}$ , and load conditions.

2. Calculate total power dissipation using:

$$P_T = V_{OUT} \times I_{LOAD} \times \left( \frac{1}{\eta} - 1 \right) \quad (\text{eq. 8})$$

where  $\eta$  is efficiency.

Estimate inductor copper losses using:

$$P_L = I_{LOAD}^2 \times DCR_L \quad (\text{eq. 9})$$

3. Determine IC losses by removing inductor losses (step 3) from total dissipation:

$$P_{IC} = P_T - P_L \quad (\text{eq. 10})$$

4. Determine device operating temperature:

$$\Delta T = P_{IC} \times \theta_{JA} \quad (\text{eq. 11})$$

and

$$T_{IC} = T_A + \Delta T$$

It is important to note that the  $R_{DS(ON)}$  of the IC's power MOSFETs increases linearly with temperature at about 0.21%/°C. This causes the efficiency ( $\eta$ ) to degrade with increasing die temperature.

## Recommended External Components

**Table 14. RECOMMENDED CAPACITORS**

Component	Quantity	Vendor	Vendor	C (μF)	Size	Rated
$C_{OUT}$	2 Pieces	C2012X5R0J226M	TDK	22	0805	6.3 V
$C_{IN}$	1 Piece	C2012X5R1A106M	TDK	10	0805	10 V

**Table 15. RECOMMENDED INDUCTORS**

Manufacturer	Part#	L (nH)	DCR (mΩ)	$I_{SAT}$	L	W	H
TOKO	DFE201612E-R47M	470	20	6.1	2.0	1.6	1.2
TOKO	DFE252012F-R33M	330	14	8.5	2.5	2.0	1.2

Layout Recommendation

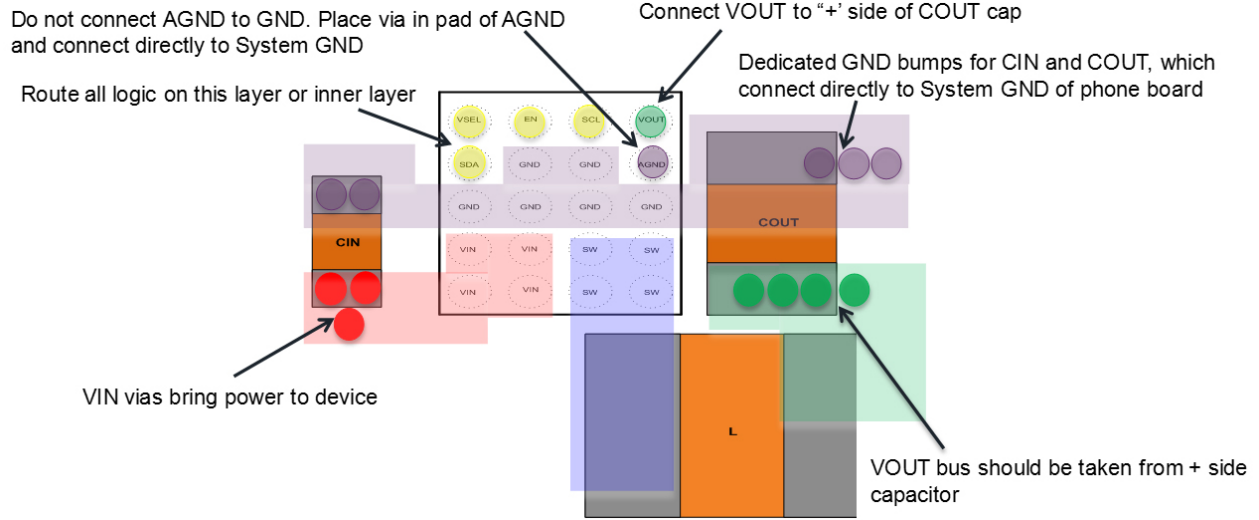
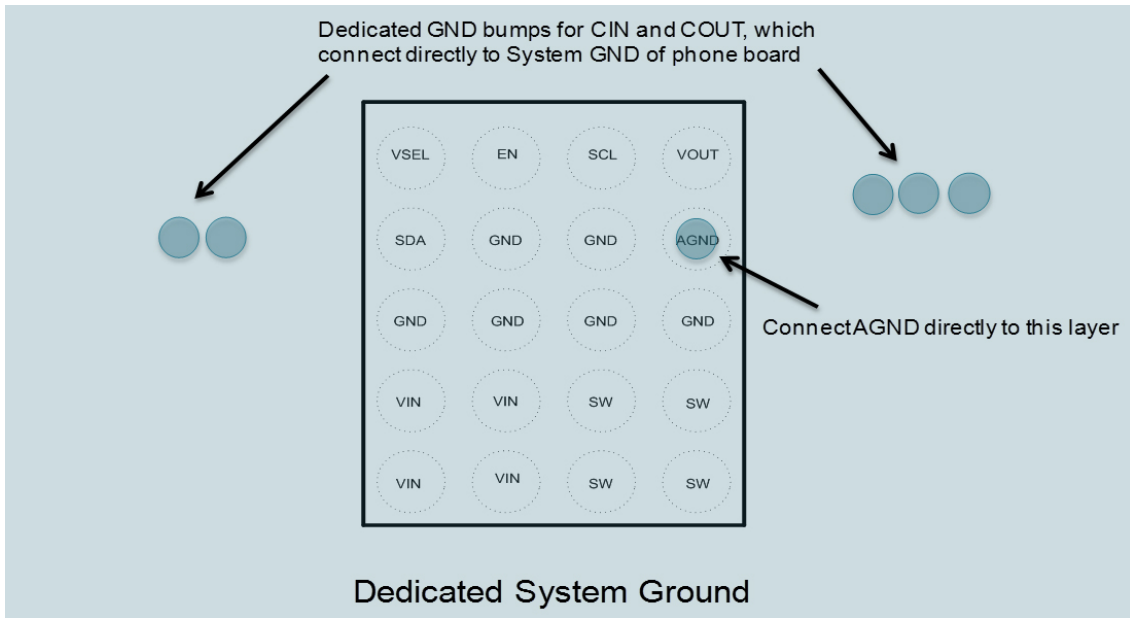

Figure 20. Guidance for Layer 1

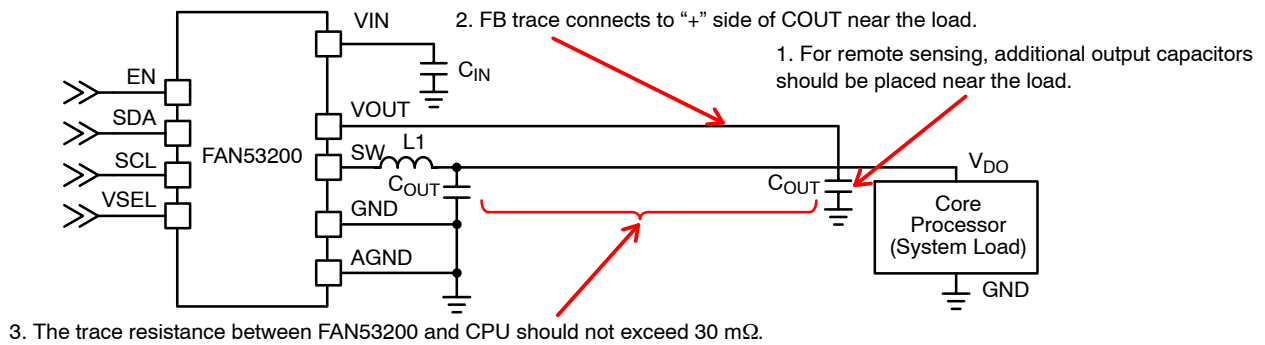

Figure 21. Guidance for Layer 2

# FAN53200



**Figure 22. Guidance for Layer 3**



3. The trace resistance between FAN53200 and CPU should not exceed 30 mΩ.

This table provides resistance values for given Copper Oz

Width (mils)	Length (mils)	Copper (Oz)	Resistance (mΩ)
25	500	2	4.9
25	500	1.5	6.5
25	500	1	9.7
25	500	0.5	19.4

**Figure 23. Remote Sensing Schematic**

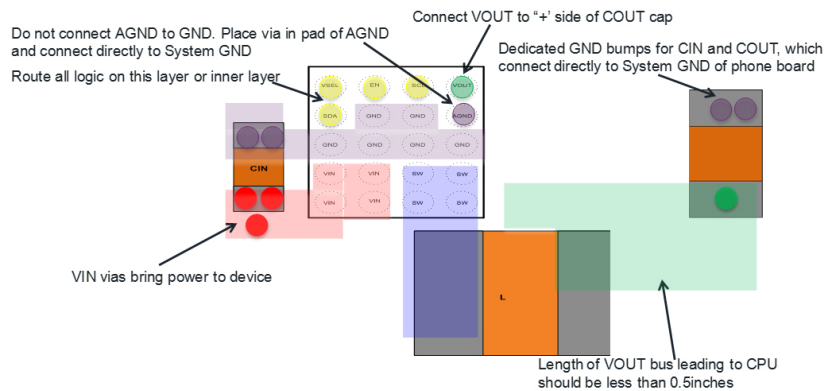

**Figure 24. Remote Sensing Guidance, Top Layer**

TinyBuck is a registered trademark of Semiconductor Components Industries, LLC (SCILLC) or its subsidiaries in the United States and/or other countries.

ARM is a registered trademark of ARM Limited (or its subsidiaries) in the EU and/or elsewhere.

OMAP is a trademark and brand of Texas Instruments Incorporated.

NovaThor is a trademark of ST-Ericsson.

ARMADA is a trademark of Emergency Technology, Inc.

Krait is a trademark of Qualcomm Incorporated.

**WLCSP20 2.015x1.615x0.586**  
CASE 567SH  
ISSUE O

DATE 30 NOV 2016

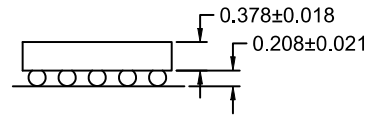
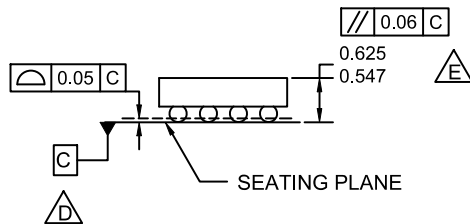
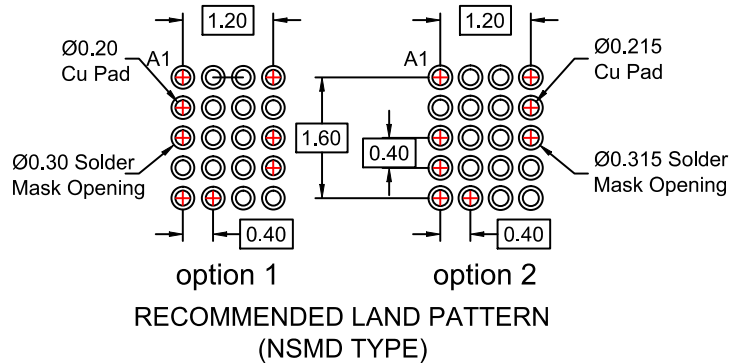
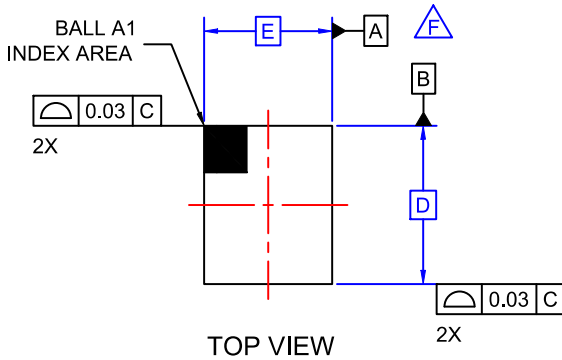

SIDE VIEWS

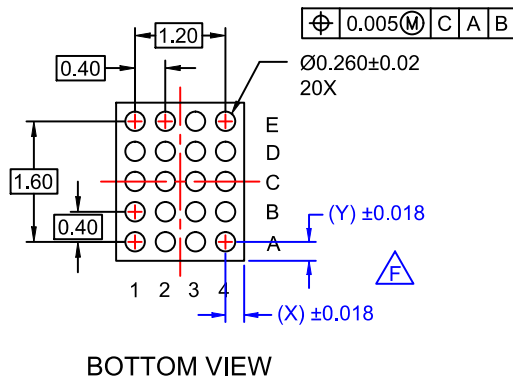

**NOTES:**

- A. NO JEDEC REGISTRATION APPLIES.
- B. DIMENSIONS ARE IN MILLIMETERS.
- C. DIMENSIONS AND TOLERANCE PER ASMEY14.5M, 2009.
- D. DATUM C IS DEFINED BY THE SPHERICAL CROWNS OF THE BALLS.
- E. PACKAGE NOMINAL HEIGHT IS 586 MICRONS ±39 MICRONS (547-625 MICRONS).
- F. FOR DIMENSIONS D, E, X, AND Y SEE PRODUCT DATASHEET.

<b>DOCUMENT NUMBER:</b>	<b>98AON16602G</b>	Electronic versions are uncontrolled except when accessed directly from the Document Repository. Printed versions are uncontrolled except when stamped "CONTROLLED COPY" in red.
<b>DESCRIPTION:</b>	<b>WLCSP20 2.015x1.615x0.586</b>	<b>PAGE 1 OF 1</b>

onsemi and onsemi are trademarks of Semiconductor Components Industries, LLC dba onsemi or its subsidiaries in the United States and/or other countries. onsemi reserves the right to make changes without further notice to any products herein. onsemi makes no warranty, representation or guarantee regarding the suitability of its products for any particular purpose, nor does onsemi assume any liability arising out of the application or use of any product or circuit, and specifically disclaims any and all liability, including without limitation special, consequential or incidental damages. onsemi does not convey any license under its patent rights nor the rights of others.

**onsemi**, **Onsemi**, and other names, marks, and brands are registered and/or common law trademarks of Semiconductor Components Industries, LLC dba "**onsemi**" or its affiliates and/or subsidiaries in the United States and/or other countries. **onsemi** owns the rights to a number of patents, trademarks, copyrights, trade secrets, and other intellectual property. A listing of **onsemi**'s product/patent coverage may be accessed at [www.onsemi.com/site/pdf/Patent-Marking.pdf](http://www.onsemi.com/site/pdf/Patent-Marking.pdf). **onsemi** reserves the right to make changes at any time to any products or information herein, without notice. The information herein is provided "as-is" and **onsemi** makes no warranty, representation or guarantee regarding the accuracy of the information, product features, availability, functionality, or suitability of its products for any particular purpose, nor does **onsemi** assume any liability arising out of the application or use of any product or circuit, and specifically disclaims any and all liability, including without limitation special, consequential or incidental damages. Buyer is responsible for its products and applications using **onsemi** products, including compliance with all laws, regulations and safety requirements or standards, regardless of any support or applications information provided by **onsemi**. "Typical" parameters which may be provided in **onsemi** data sheets and/or specifications can and do vary in different applications and actual performance may vary over time. All operating parameters, including "Typicals" must be validated for each customer application by customer's technical experts. **onsemi** does not convey any license under any of its intellectual property rights nor the rights of others. **onsemi** products are not designed, intended, or authorized for use as a critical component in life support systems or any FDA Class 3 medical devices or medical devices with a same or similar classification in a foreign jurisdiction or any devices intended for implantation in the human body. Should Buyer purchase or use **onsemi** products for any such unintended or unauthorized application, Buyer shall indemnify and hold **onsemi** and its officers, employees, subsidiaries, affiliates, and distributors harmless against all claims, costs, damages, and expenses, and reasonable attorney fees arising out of, directly or indirectly, any claim of personal injury or death associated with such unintended or unauthorized use, even if such claim alleges that **onsemi** was negligent regarding the design or manufacture of the part. **onsemi** is an Equal Opportunity/Affirmative Action Employer. This literature is subject to all applicable copyright laws and is not for resale in any manner.

## ADDITIONAL INFORMATION

### TECHNICAL PUBLICATIONS:

Technical Library: [www.onsemi.com/design/resources/technical-documentation](http://www.onsemi.com/design/resources/technical-documentation)  
onsemi Website: [www.onsemi.com](http://www.onsemi.com)

### ONLINE SUPPORT: [www.onsemi.com/support](http://www.onsemi.com/support)

For additional information, please contact your local Sales Representative at [www.onsemi.com/support/sales](http://www.onsemi.com/support/sales)

