



TAOGLAS®



Datasheet

Havok

Part No:
PCS.06.A

Description

Low Profile LTE/Cellular 4G/3G/2G SMD Dielectric Antenna

Features:

SMD Dielectric Antenna

698~960MHz/1710~2690MHz

High Efficiency SMD antenna

Low profile 42*10*3mm

RoHS & Reach Compliant

1.	Introduction	2
2.	Specification	3
3.	Antenna Characteristics	5
4.	Radiation Patterns	9
5.	Mechanical Drawing	17
6.	Packaging	18
7.	Antenna Integration Guide	20
8.	Solder Reflow Profile	28
9.	Application Note	29
<hr/>		
	Changelog	31

Taoglas makes no warranties based on the accuracy or completeness of the contents of this document and reserves the right to make changes to specifications and product descriptions at any time without notice. Taoglas reserves all rights to this document and the information contained herein. Reproduction, use or disclosure to third parties without express permission is strictly prohibited.



1. Introduction



The Havok PCS.06.A is a low profile SMD LTE/cellular 4G/3G/2G embedded antenna designed for direct SMD mount on a device PCB. It provides high efficiency in a very small factor 42*10*3mm. If tuning is required it can be tuned for the device environment, while there is no need for new tooling.

Its rectangular shape and small size makes it very easy to integrate – packaged in tape and reel, it can be mounted via pick and place to reflow solder directly on the edge of the PCB board. This antenna is recommended to be used with long ground-plane lengths of 120mm or more to attain its highest rated efficiency, note the return loss and efficiency graphs.

Typical Applications Include:

- Connected Health
- Handheld Devices
- Wearables

The antenna is suitable for lower cost LTE/cellular applications due to the ease of integration. Contact your regional Taoglas customer support team for quick and professional support from our senior engineering team on integration and matching of the antenna to your device.

2. Specification

LTE Electrical								
Band	Frequency (MHz)	Efficiency (%)	Average Gain (dB)	Peak Gain (dBi)	Impedance	Polarization	Radiation Pattern	Max. input power
5GNR/4G Band71	617-698	27.3	-5.64	-0.22	50 Ω	Linear	Omni	2W
4G/3G Band 12,13,14,17,28,29	698-806	65.3	-1.85	2.60				
4G/3G/NB-IoT/Cat M Band 5,8,18,19,20,26,27	824-960	61.5	-2.11	2.22				
4G/3G Band 1,2,3,4,9,23,25,35,39,66	1710-2200	69.1	-1.61	5.93				
4G/3G Band 7,30,38,40,41	2300-2690	58.2	-2.35	4.35				

Mechanical	
Antenna Dimensions	42mm x 10mm x 3mm
Material	FR4
Weight	2.50g
Soldering Type	SMD Reflow

Environmental	
Operation Temperature	-40°C ~ +85°C
Storage Temperature	-40°C ~ +85°C
Moisture Sensitivity Level	3

5G/4G Bands			
Band Number	5G NR / FR1 / LTE / LTE-Advanced / WCDMA / HSPA / HSPA+ / TD-SCDMA		
	Uplink	Downlink	Covered
B1	1920 to 1980	2110 to 2170	✓
B2	1850 to 1910	1930 to 1990	✓
B3	1710 to 1785	1805 to 1880	✓
B4	1710 to 1755	2110 to 2155	✓
B5	824 to 849	869 to 894	✓
B7	2500 to 2570	2620 to 2690	✓
B8	880 to 915	925 to 960	✓
B9*	1749.9 to 1784.9	1844.9 to 1879.9	✓
B11	1427.9 to 1447.9	1475.9 to 1495.9	✓
B12	699 to 716	729 to 746	✓
B13	777 to 787	746 to 756	✓
B14	788 to 798	758 to 768	✓
B17	704 to 716	734 to 746	✓
B18	815 to 830	860 to 875	✓
B19	830 to 845	875 to 890	✓
B20	832 to 862	791 to 821	✓
B21	1447.9 to 1462.9	1495.9 to 1510.9	✓
B22*	3410 to 3490	3510 to 3590	✗
B23*	2000 to 2020	2180 to 2200	✓
B24	1626.5 to 1660.5	1525 to 1559	✓
B25	1850 to 1915	1930 to 1995	✓
B26	814 to 849	859 to 894	✓
B27*	807 to 824	852 to 869	✓
B28	703 to 748	758 to 803	✓
B29		717 to 728	✓
B30	2305 to 2315	2350 to 2360	✓
B31	452.5 to 457.5	462.5 to 467.5	✗
B32		1452 to 1496	✓
B34		2010 to 2025	✓
B35		1850 to 1910	✓
B36		1930 to 1990	✓
B37		1910 to 1930	✓
B38		2570 to 2620	✓
B39		1880 to 1920	✓
B40		2300 to 2400	✓
B41		2496 to 2690	✓
B42		3400 to 3600	✗
B43		3600 to 3800	✗
B45		1447 to 1467	✓
B46		5150 to 5925	✗
B47		5855 to 5925	✗
B48		3550 to 3700	✗
B49		3550 to 3700	✗
B50		1432 to 1517	✓
B51		1427 to 1432	✓
B52		3300 to 3400	✗
B53		2483.5 to 2495	✓
B65	1920 to 2010	2110 to 2200	✓
B66	1710 to 1780	2110 to 2200	✓
B68	698 to 728	753 to 783	✓
B69		2570 to 2620	✓
B70	1695 to 1710	1995 to 2020	✓
B71	663 to 698	617 to 652	✗
B72	451 to 456	461 to 466	✗
B73	450 to 455	460 to 465	✗
B74	1427 to 1470	1475 to 1518	✓
B75		1432 to 1517	✓
B76		1427 to 1432	✓
B77		3300 to 4200	✗
B78		3300 to 3800	✗
B79		4400 to 5000	✗
B85	698 to 716	728 to 746	✓
B87	410 to 415	420 to 425	✗
B88	412 to 417	422 to 427	✗

3. Antenna Characteristics

3.1 Test Setup

AUT



Vector Network Analyzer

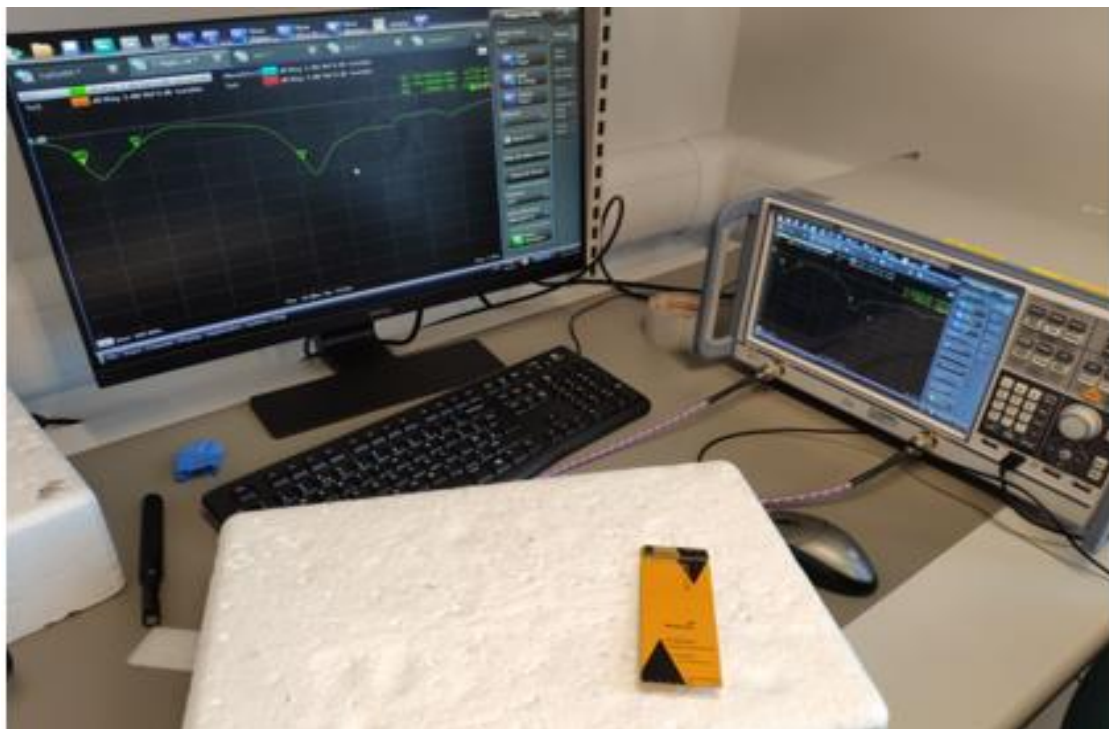

3.2 Return Loss

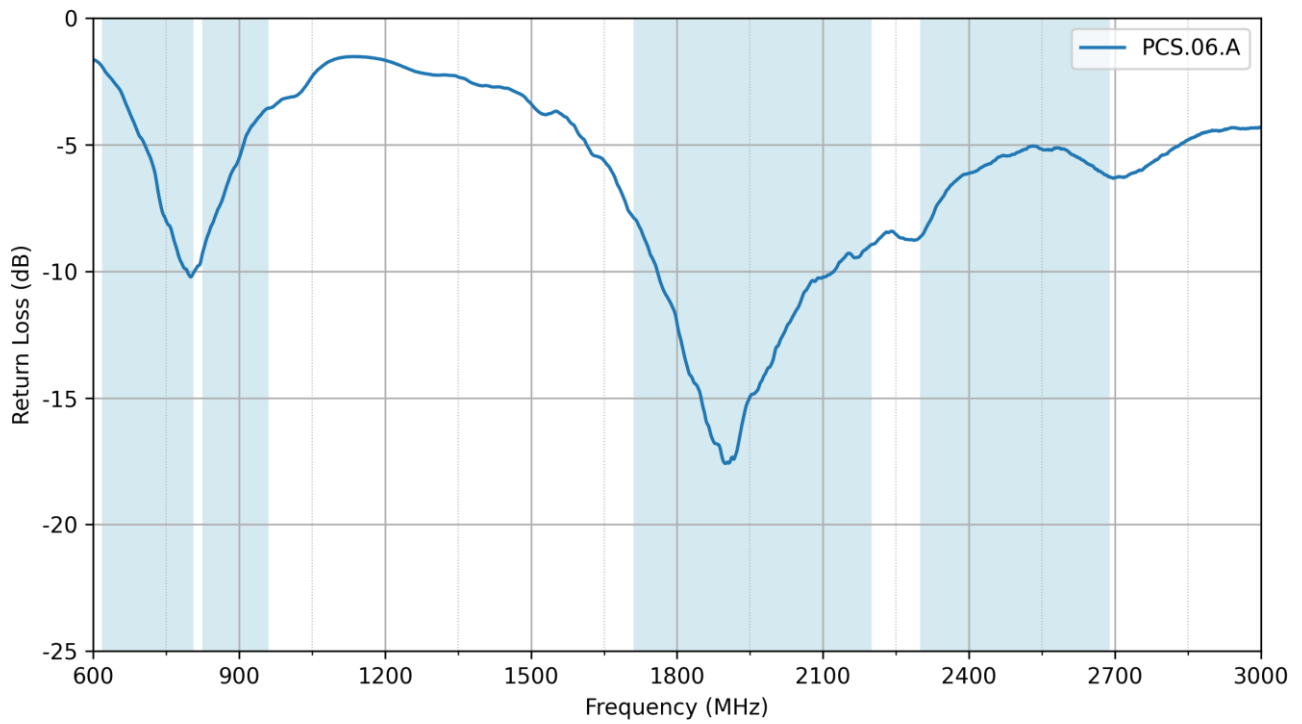

3.3 VSWR

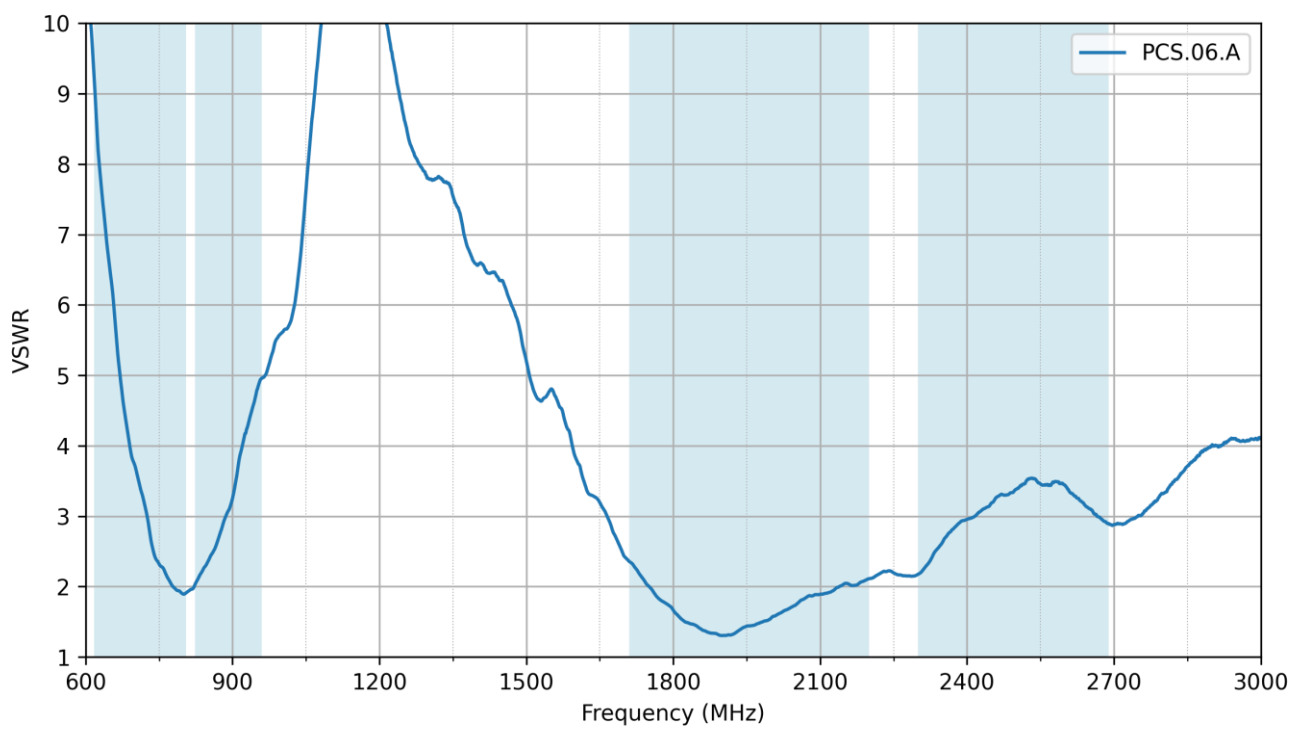

3.4 Efficiency

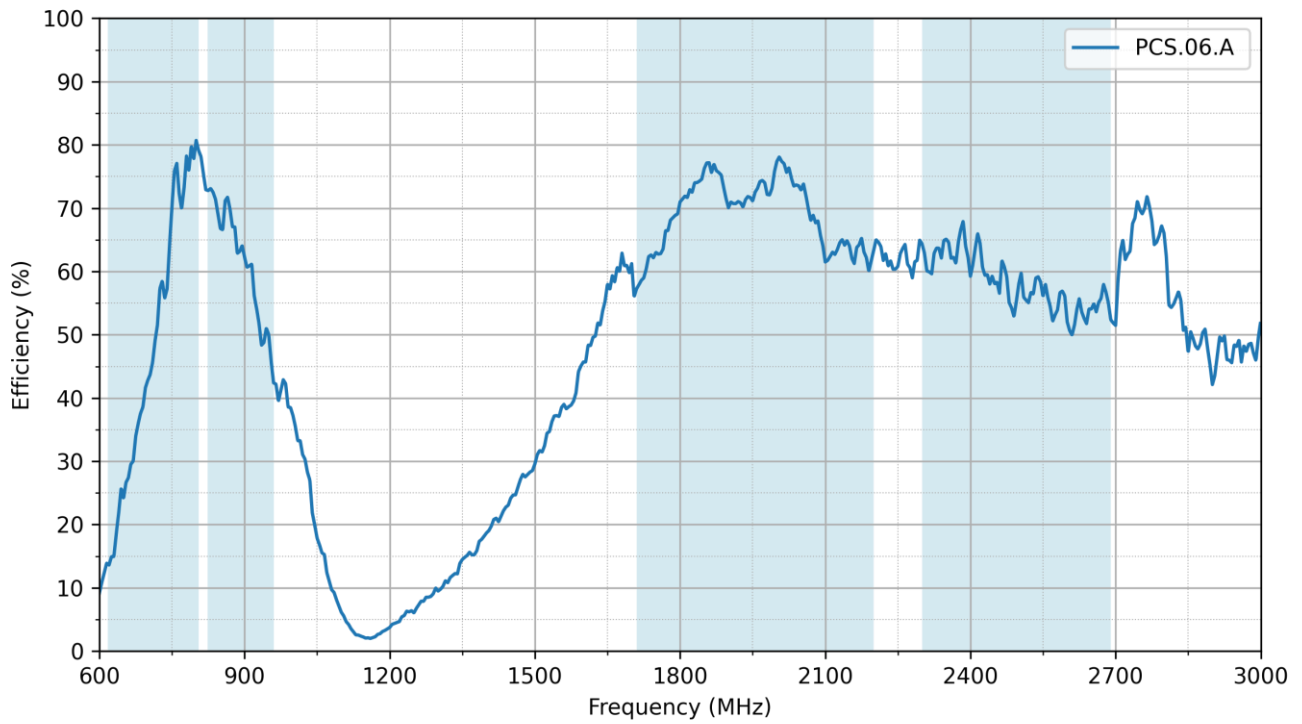

3.5 Average Gain

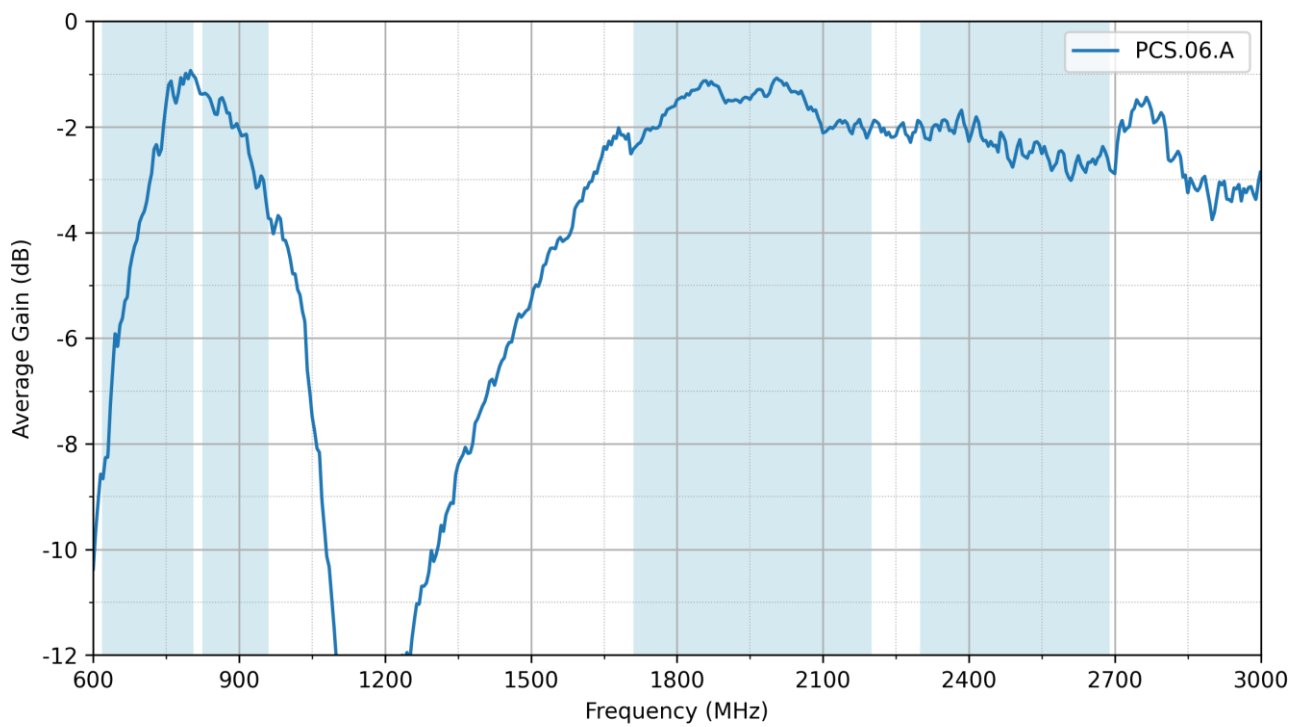

3.6 Peak Gain

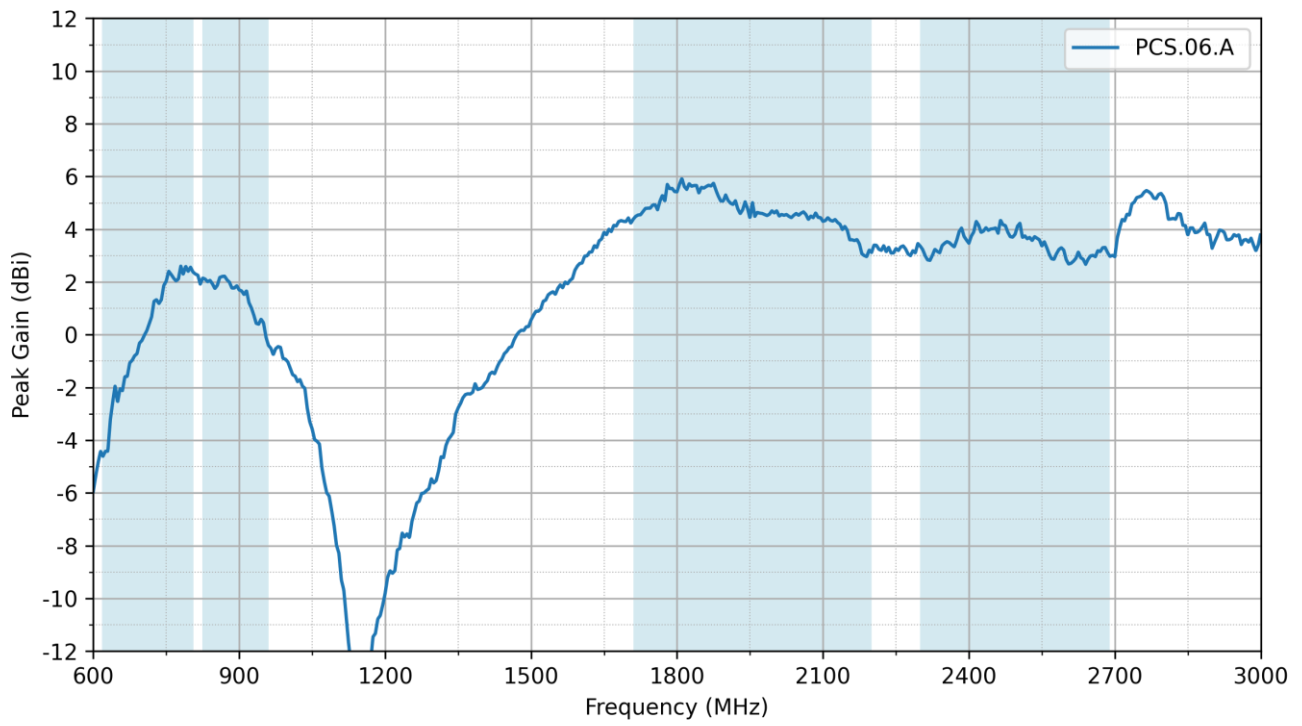

4. Radiation Patterns

4.1 Test Setup

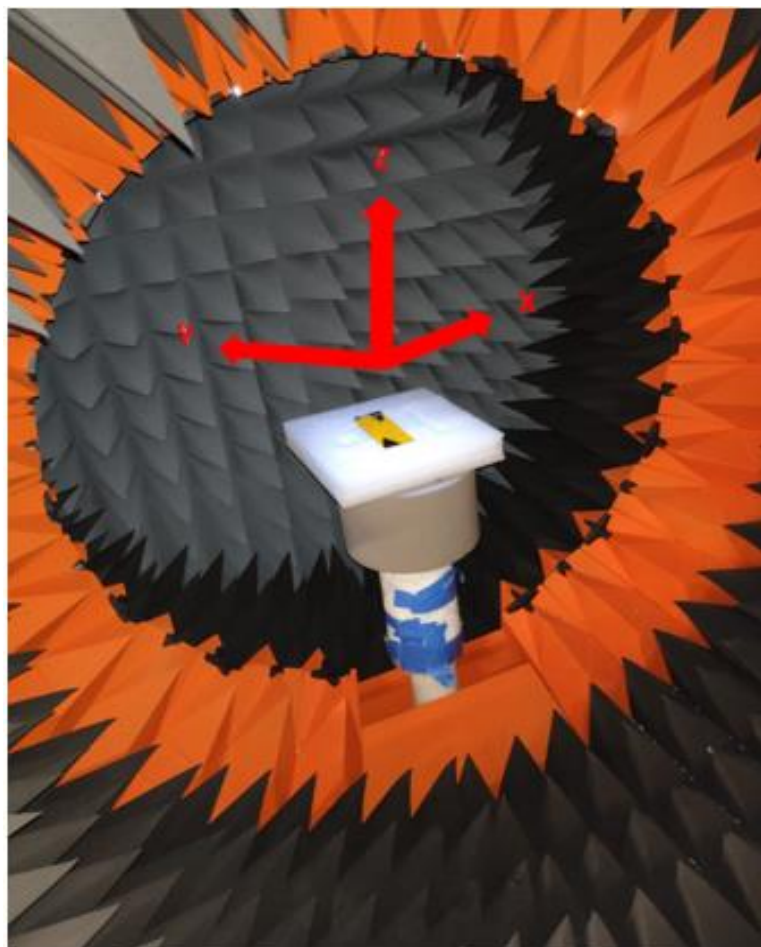
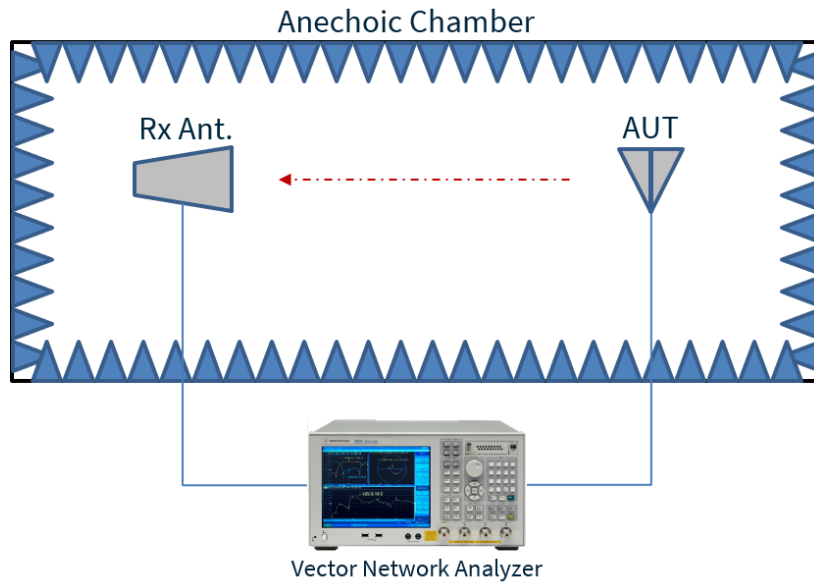

4.1 PCS.06.A Patterns at 700 MHz

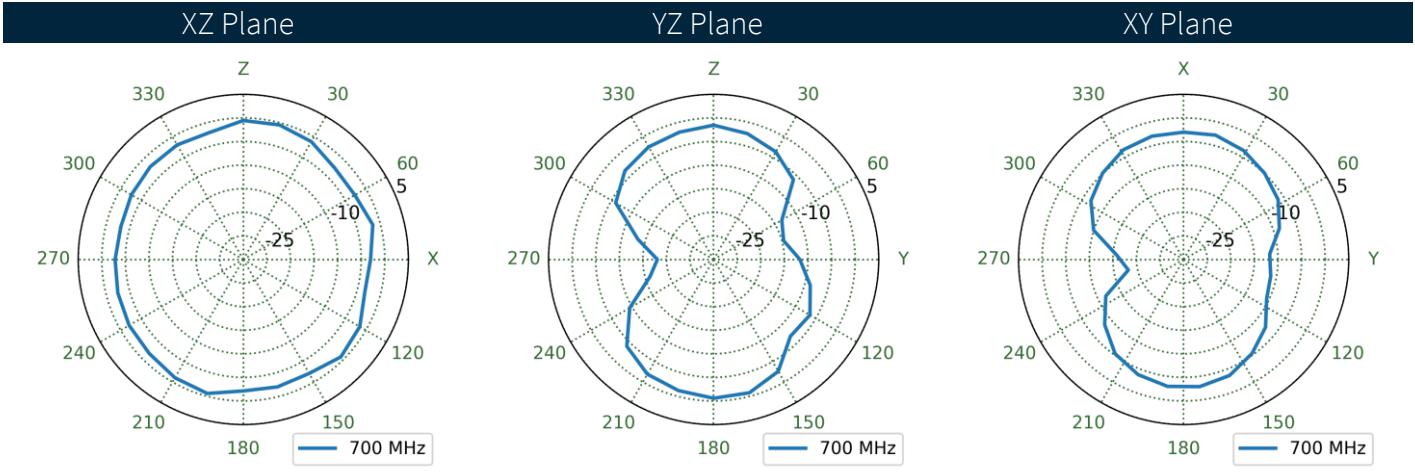
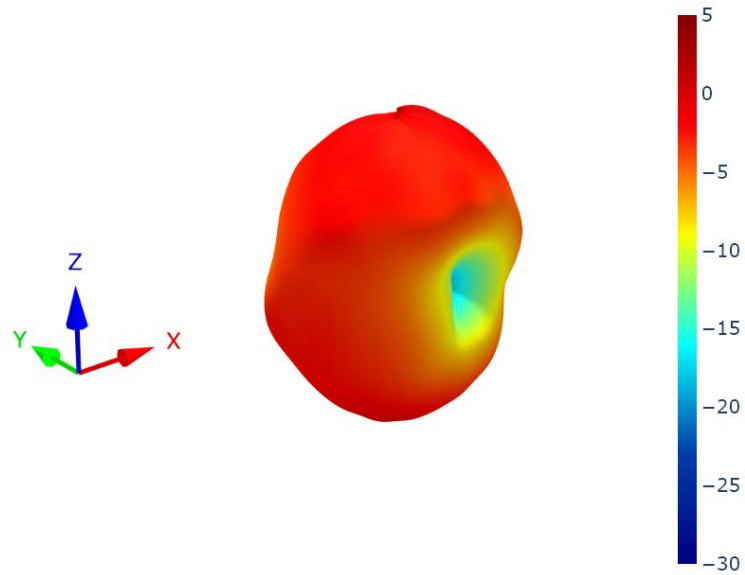

4.2 PCS.06.A Patterns at 880 MHz

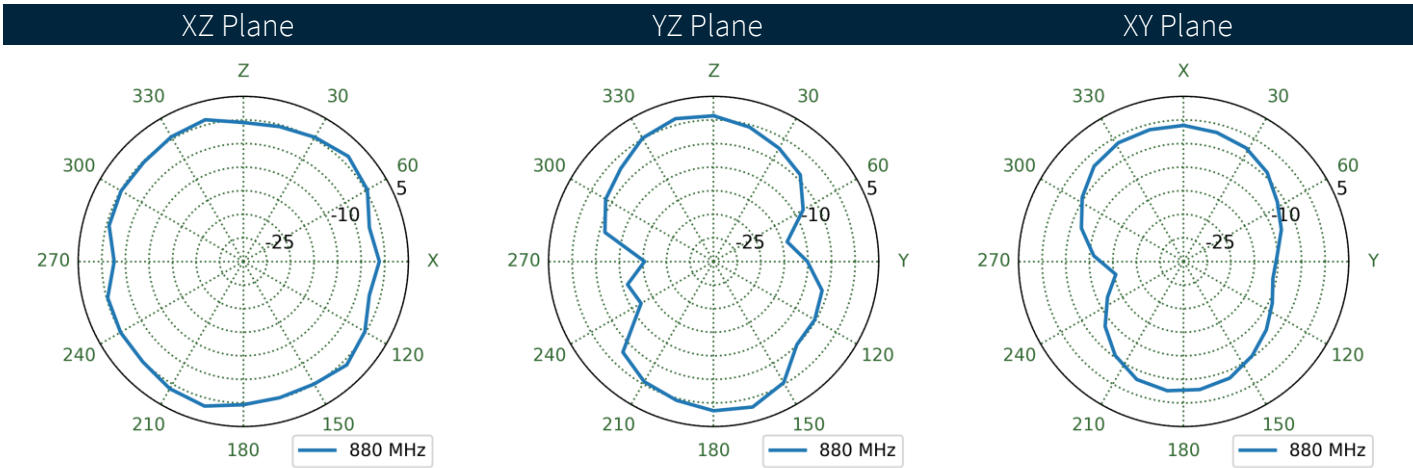
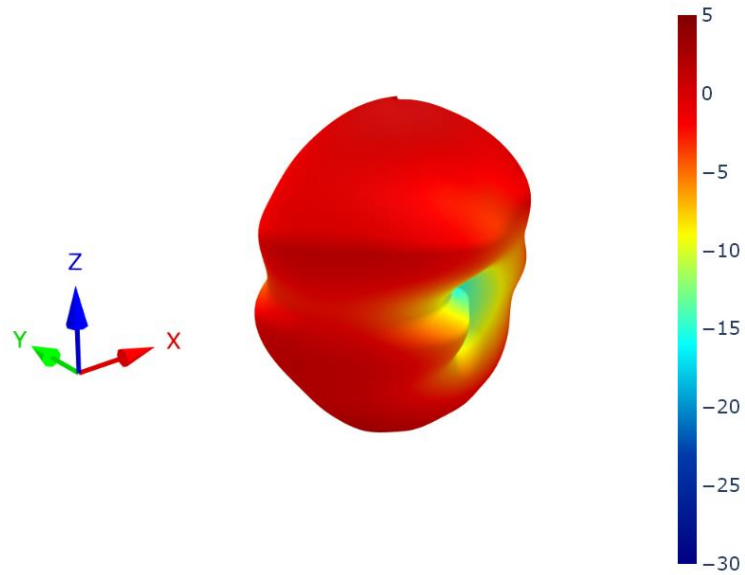

4.3 PCS.06.A Patterns at 960 MHz

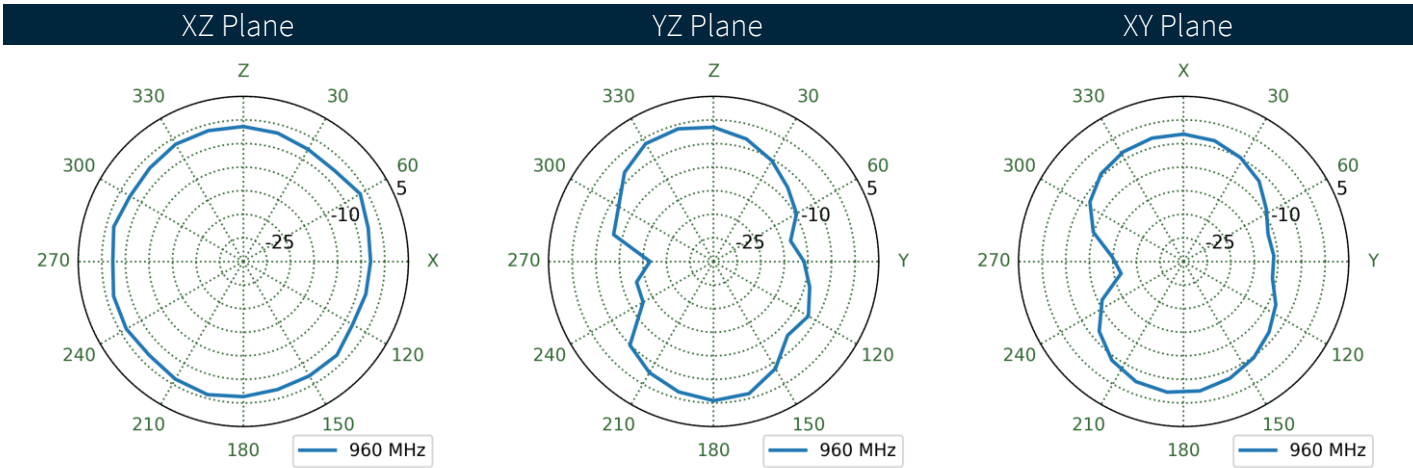
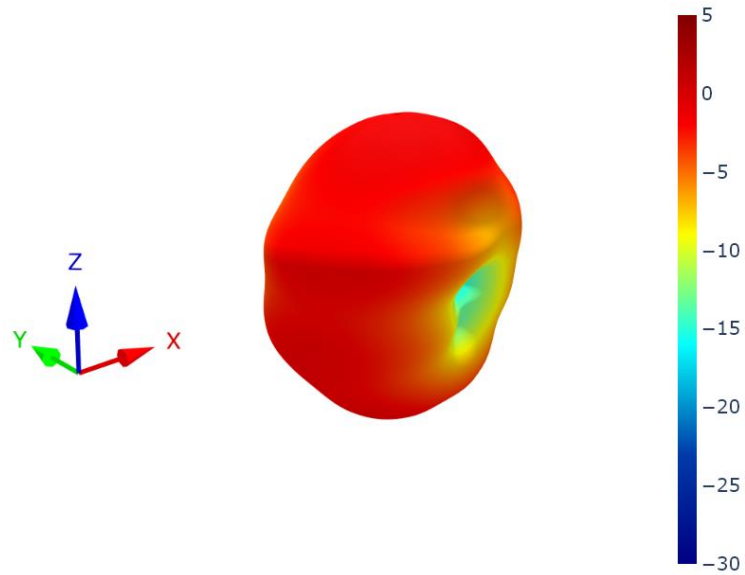

4.4 PCS.06.A Patterns at 1710 MHz

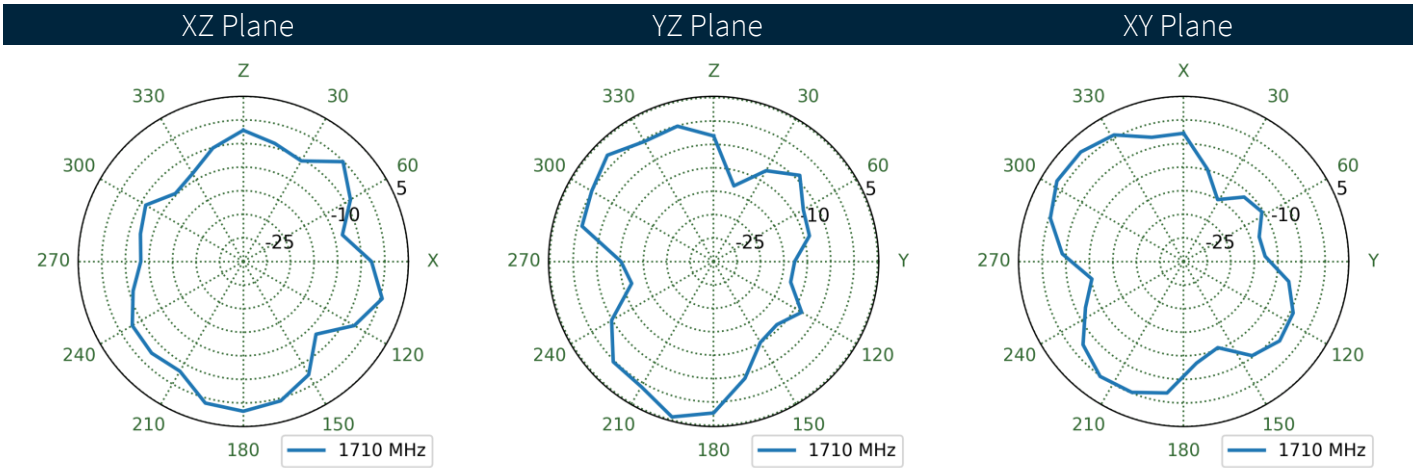
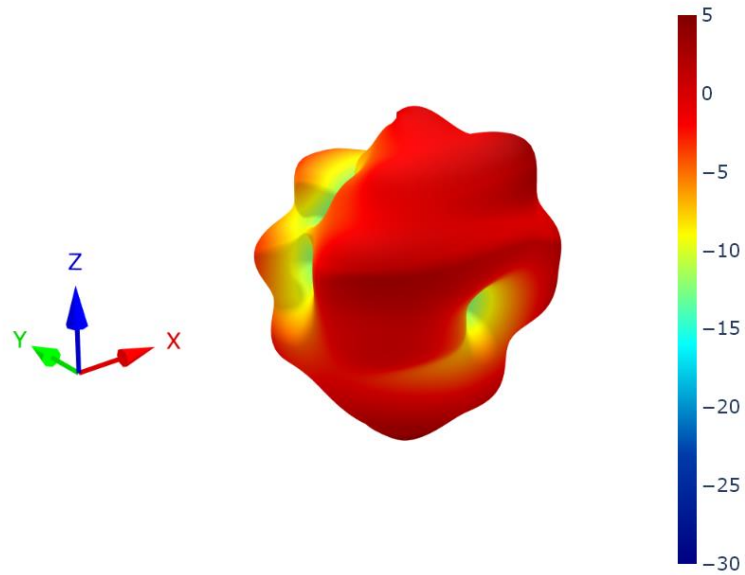

4.5 PCS.06.A Patterns at 1880 MHz

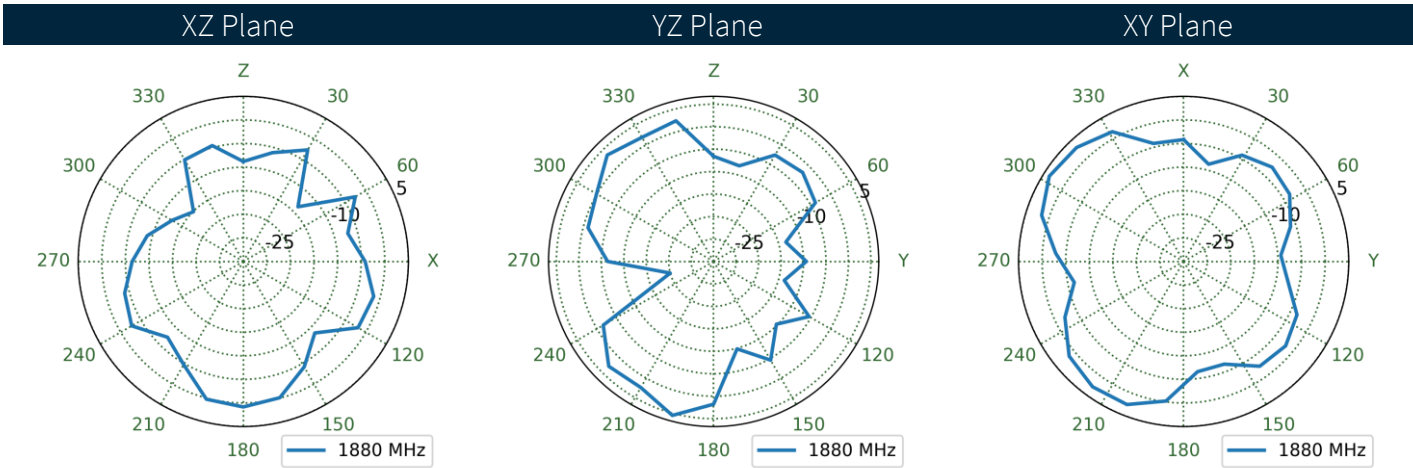
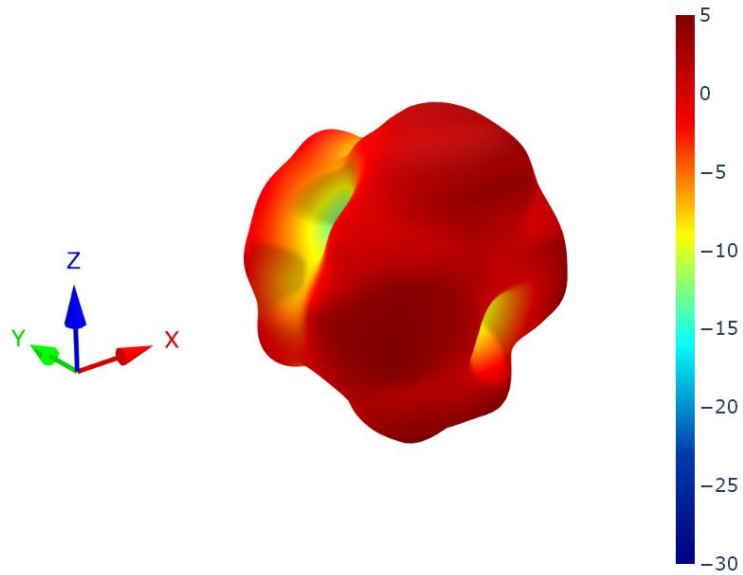

4.6 PCS.06.A Patterns at 2170 MHz

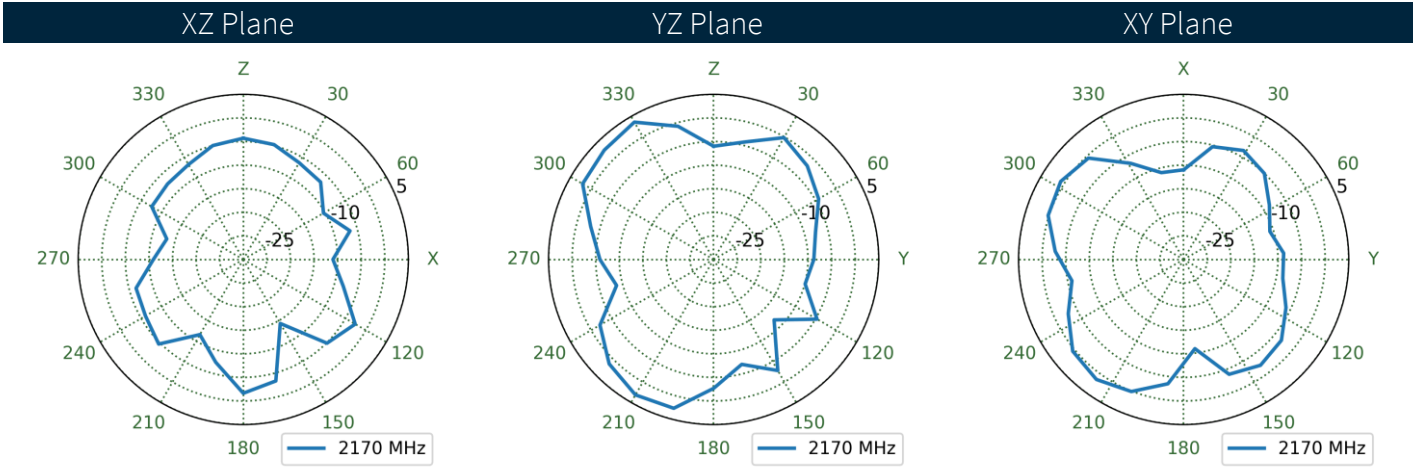
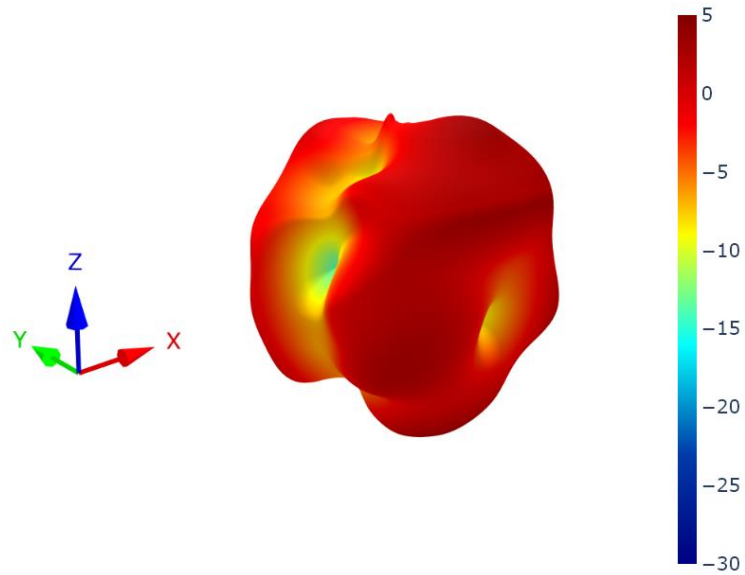

4.7 PCS.06.A Patterns at 2690 MHz

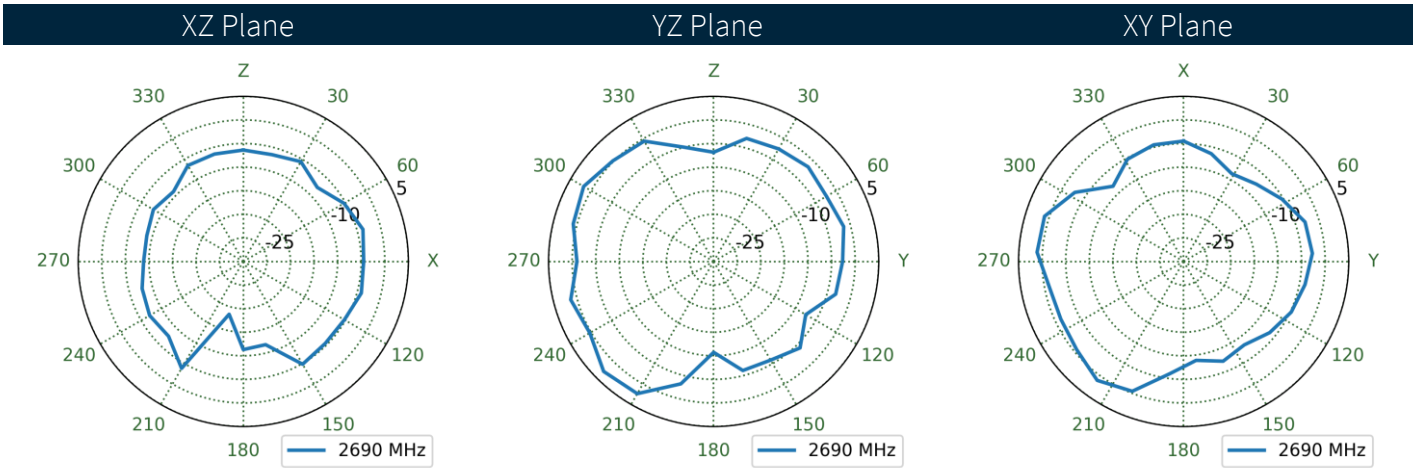
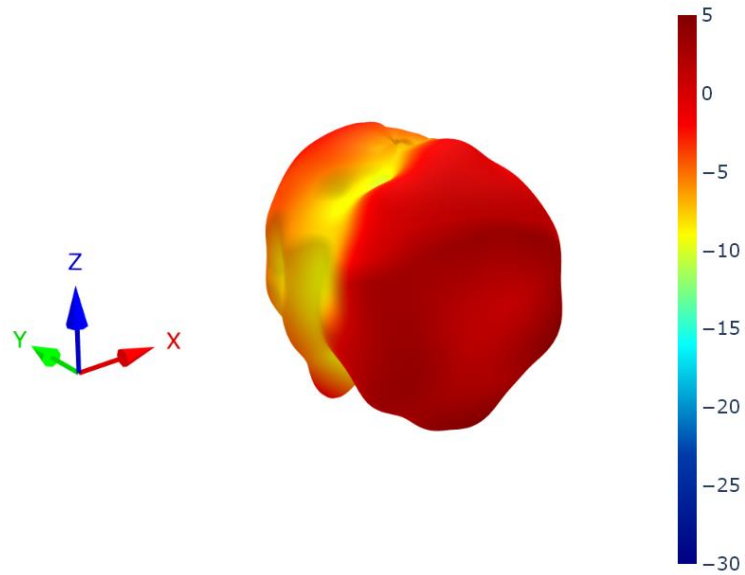

5. Mechanical Drawing

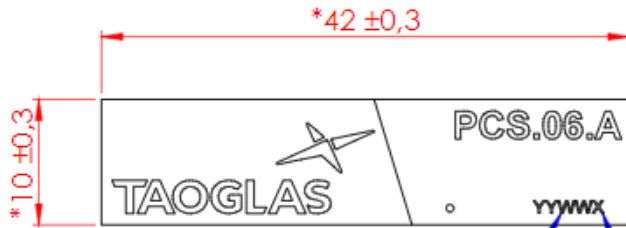

YYWW - DATE CODE
PRODUCTION YEAR AND WEEK

X-VENDOR CODE
CODING RULE:
A.B.C...MEANS VENDOR CODE

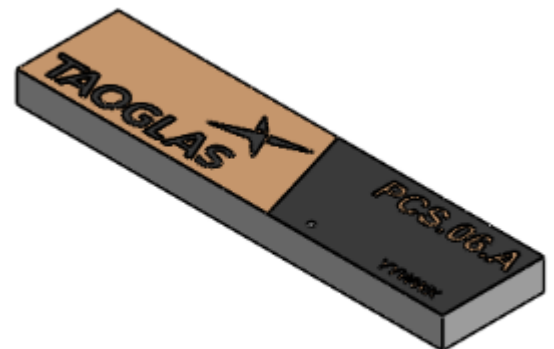
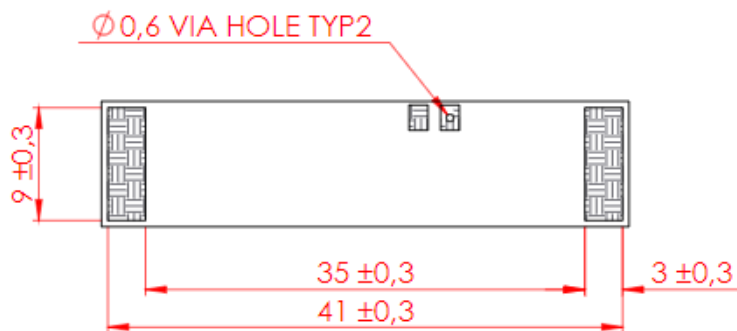
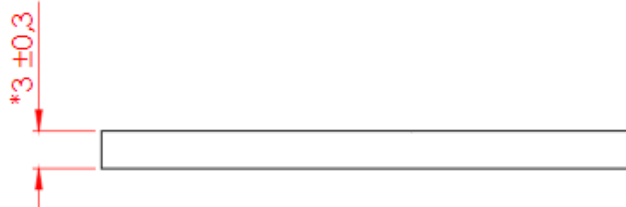

MODEL VIEW

6. Packaging

1000 pc PCS.06.A per reel
 Dimensions - Ø330*60mm
 Weight - 3230g

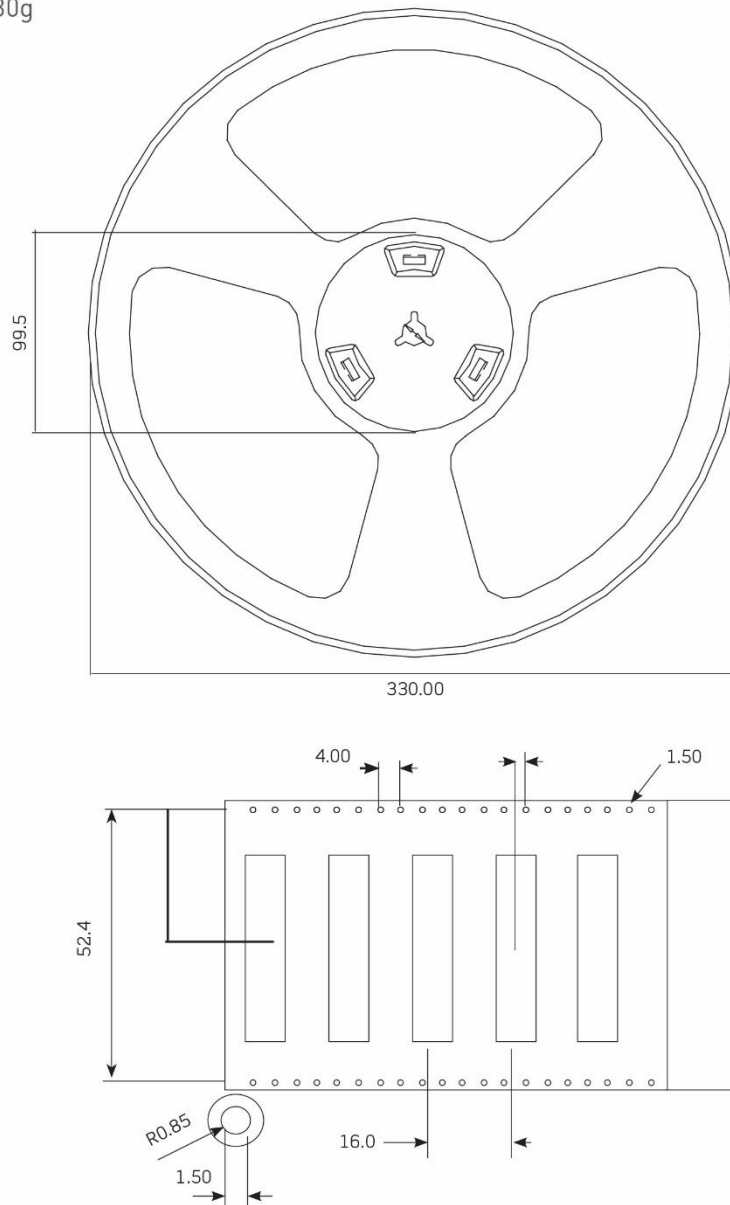

1000 pcs PCS.06.A reel
 Dimensions - 330*330*60mm
 Weight -3230g

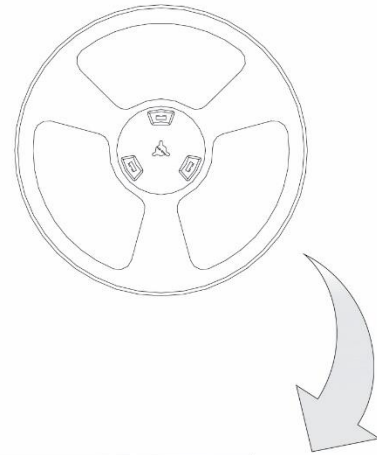

1000 pcs PCS.06.A / 1 Reel in small box
 Dimensions - 340*340*90mm
 Weight -3.5Kg

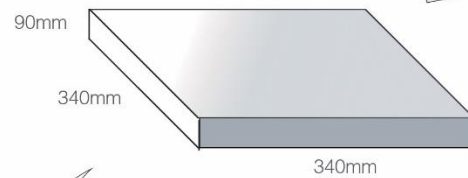

3 reels, 3000 pcs in one carton
 Carton Dimensions - 370*360*275mm
 Weight -11.3Kg

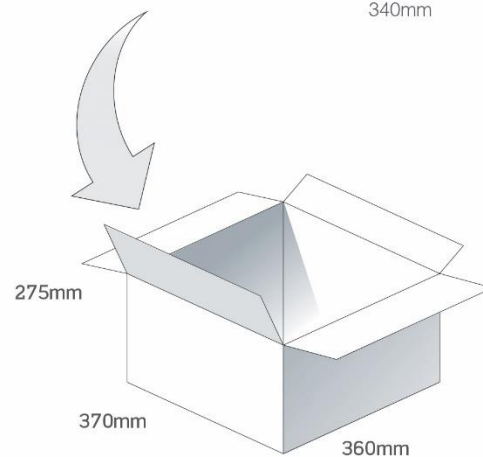

Pallet Dimensions 1200*1000*1320mm
 24 Cartons per Pallet
 6 Cartons per layer
 4 Layers

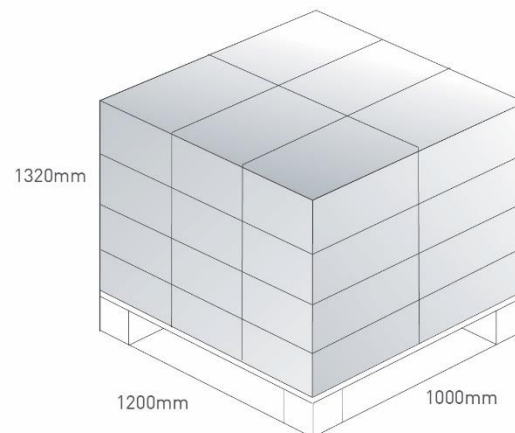

7. Antenna Integration Guide



7.1 Schematic and Symbol Definition

The circuit symbol for the antenna is shown below. The antenna has 4 pins with only two pins (Pin 1 and Pin 2) as functional. Pins 3 and 4 are for mechanical strength.

Pin	Description
1	RF Feed
2	Ground
3, 4	Mechanical, Not Connected

PCS.06.A
ANT1

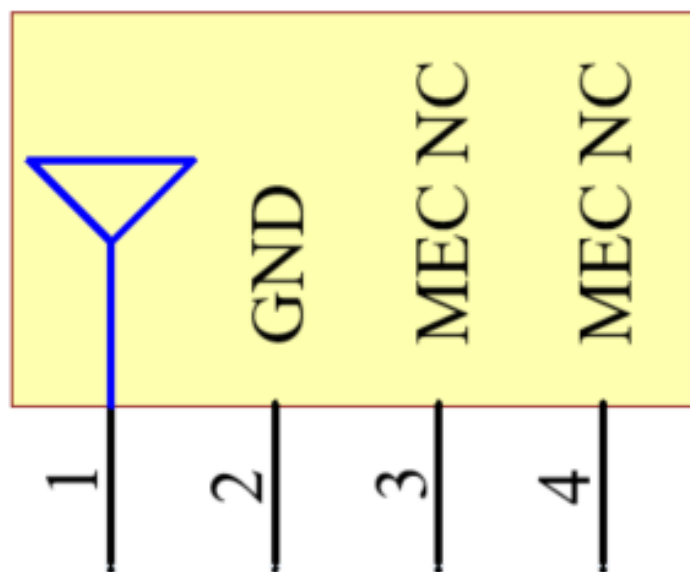

Please note you can download the design files, 3D model, 2D drawings and CST simulation files from the website here:

<https://www.taoglas.com/product/havok-pcs-06-2g3g4g-low-profile-smd-antenna-2/>

7.2 Antenna Integration

Whatever the size of the PCB, the antenna should ideally be placed on the PCB's shortest side, to take advantage of the ground plane. Optimized matching components can be placed as shown.

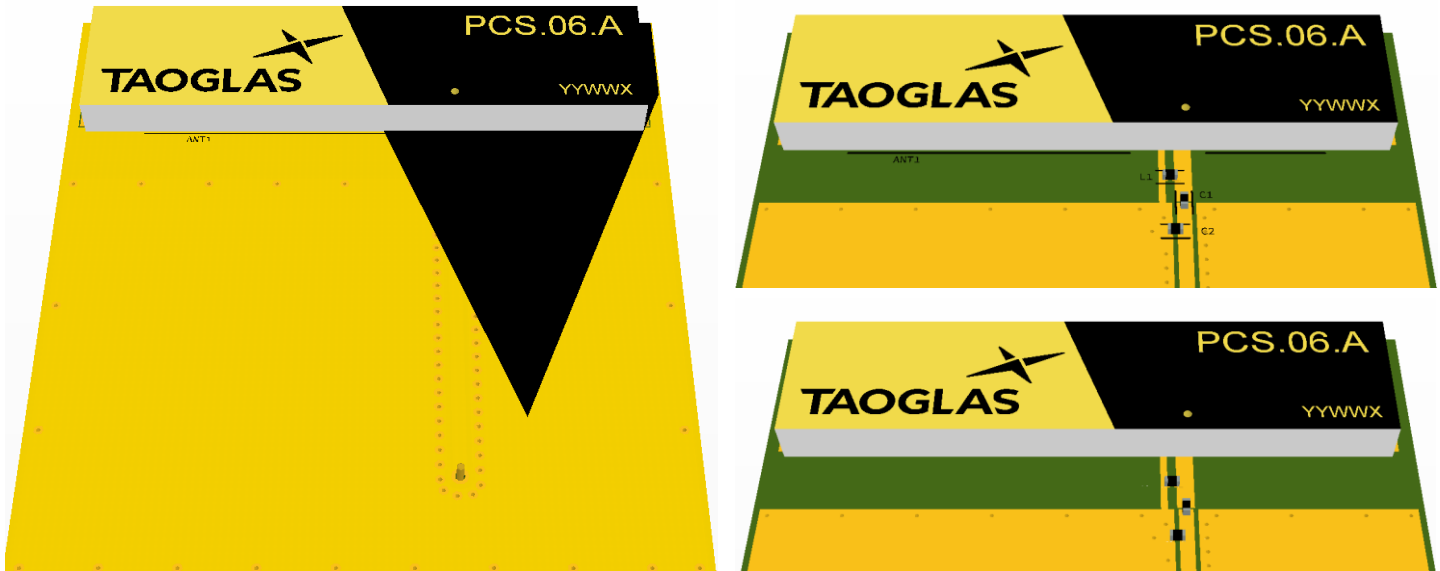

7.3 PCB Layout

The footprint and clearance on the PCB must meet the antenna specification. An example of the PCB layout shows the antenna footprint with clearance. Note the placement of the optimized components. L1 is positioned outside the ground plane and C1 is sitting across the ground plane and the copper clearance area. C2 is optional as a component but it is recommended to include these pads in case they are needed.

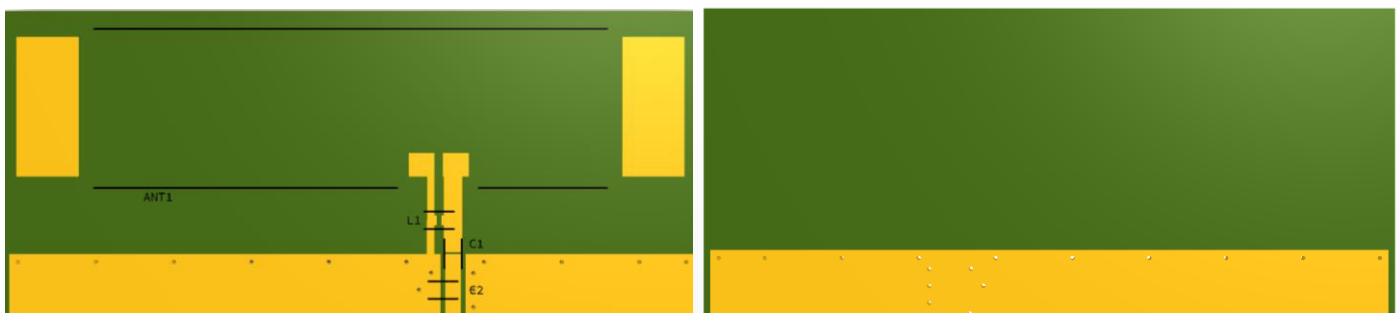

Topside

Bottom Side

7.4 PCB Clearance

Below shows the antenna footprint and clearance through ALL layers on the PCB. Only the antenna pads and connections to feed and GND are present within this clearance area (marked RED). The clearance area extends to 5mm from the antenna mechanical pads to the ground area. This clearance area includes the bottom side and ALL internal layers on the PCB.

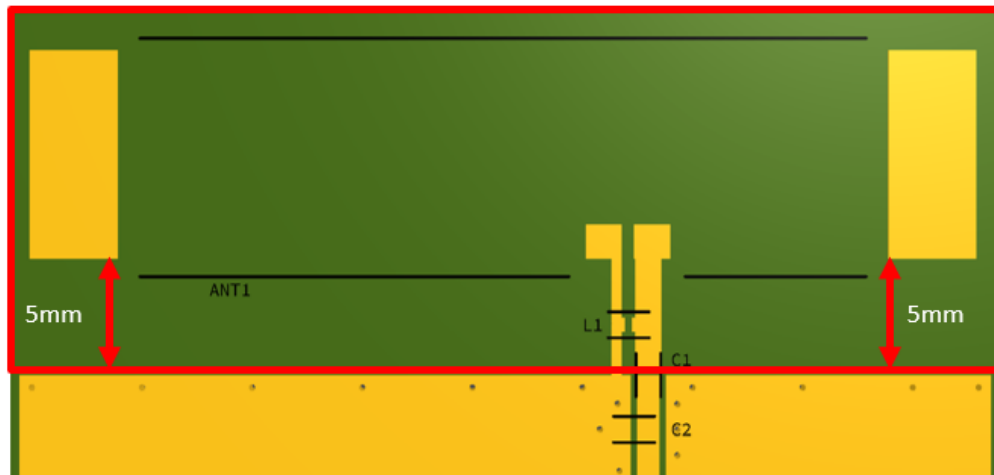

Topside

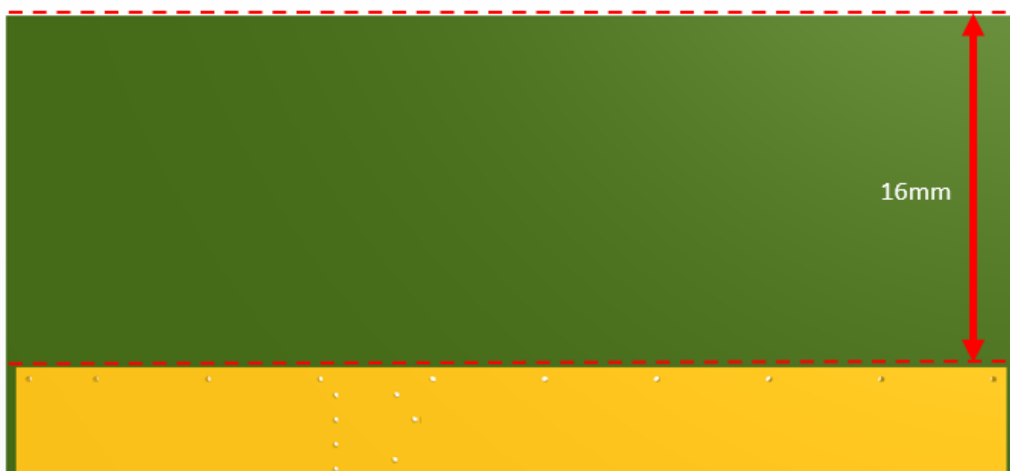

Bottom Side

7.5 Evaluation Board



7.6 Evaluation Board Ground Plane Length

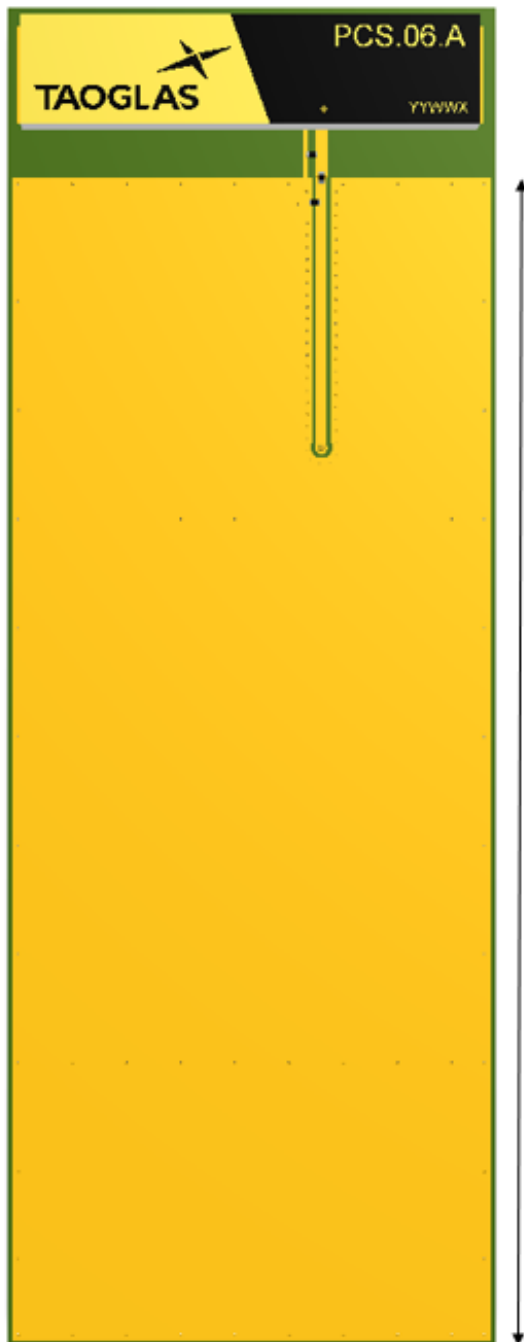

Ground Plane Length: 107mm

7.7 Evaluation Board Matching Circuit

A matching component (L1) in parallel with the PCS.06.A is required for the antenna to have optimal performance on the evaluation board, located outside of the ground plane in the space specified in the above images. C1 is also required as a matching component for this antenna. C1 is positioned sitting across the ground plane as shown in the above images. Additional matching components may be necessary for your device, so we recommend incorporating extra component footprints, forming a “pi” network, between the cellular module and the edge of the ground plane.

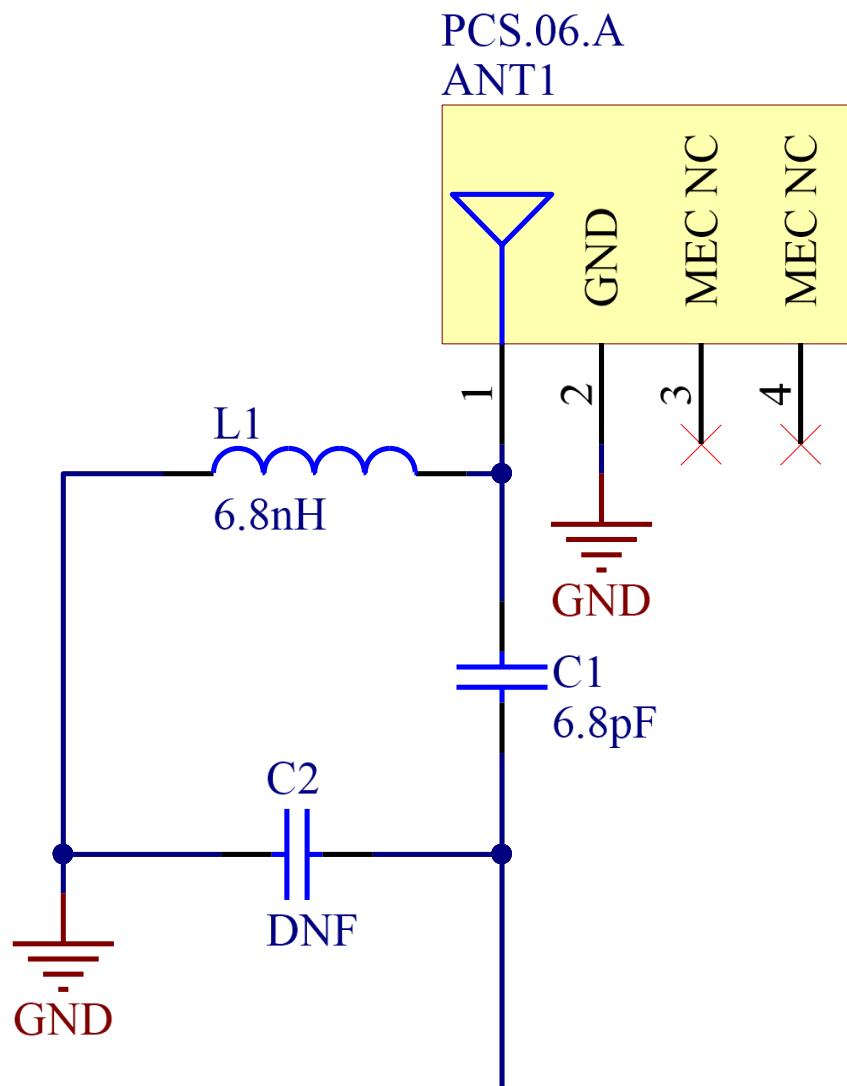

Designator	Type	Value	Description
L1	Inductor	6.8nH	TDK: MLK1005S Series
C1	Capacitor	6.8pF	Murata:GRM1555 Series
C2	Capacitor	Not Fitted	

7.8 Footprint

PIN:	DESCRIPTION:
1	FEED
2	GROUND
3	NOT CONNECTED
4	NOT CONNECTED

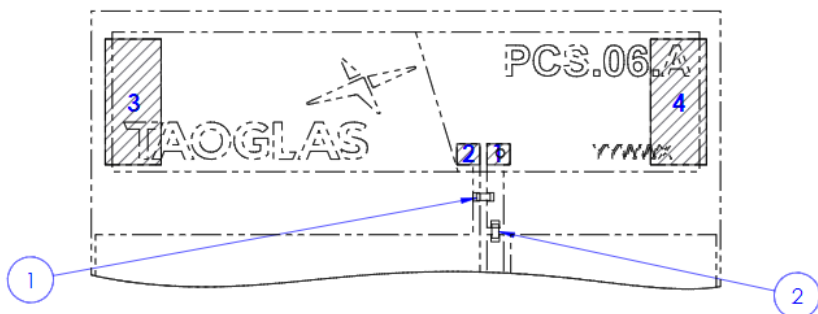

FOOTPRINT SOLDER PADS WITH PCB OUTLINE
SCALE 3:1

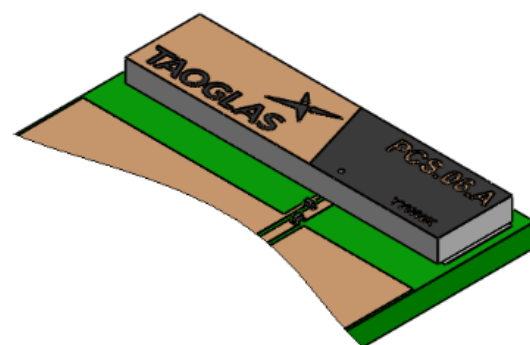

ANTENNA ON FOOTPRINT
PCB VIEW

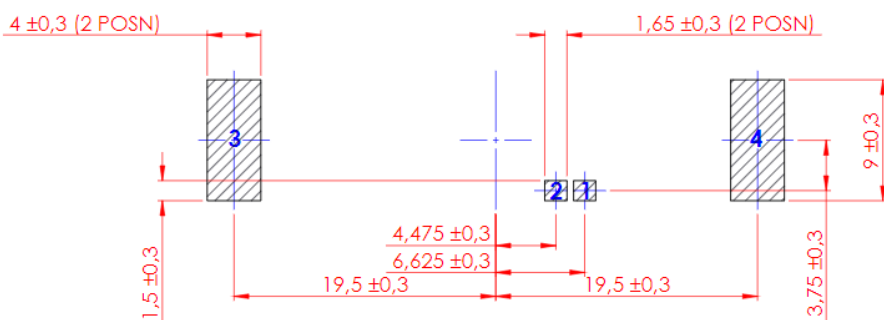

FOOTPRINT PCB
SCALE 3:1

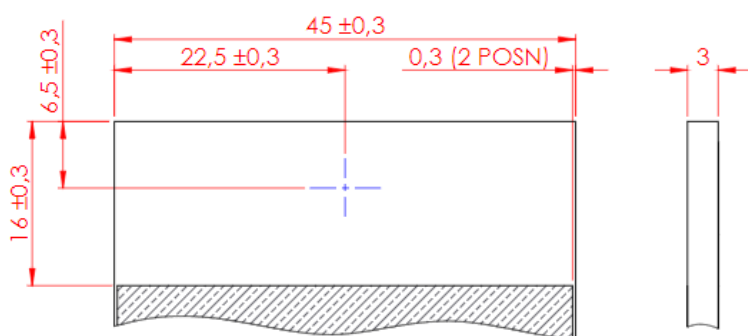

GROUND CLEARANCE BOTTOM VIEW
(SILKSCREEN NOT SHOWN)

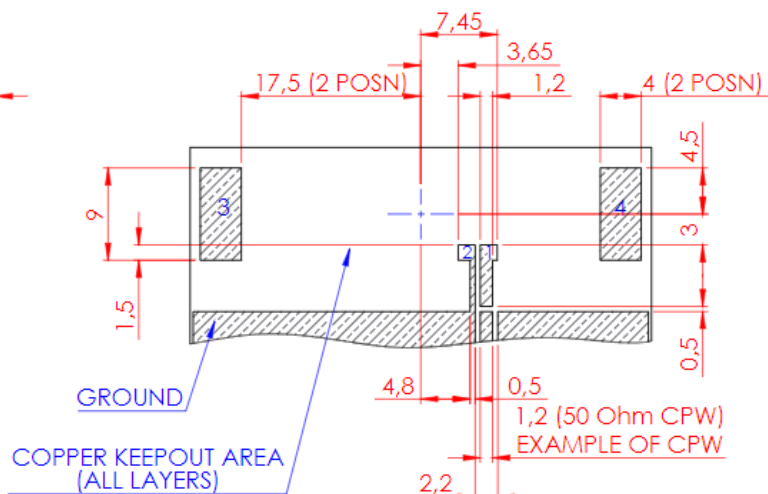

GROUND CLEARANCE TOP VIEW
(SILKSCREEN NOT SHOWN)

8. Solder Reflow Profile

The PCS.06.A can be assembled by following the recommended soldering temperatures are as follows:

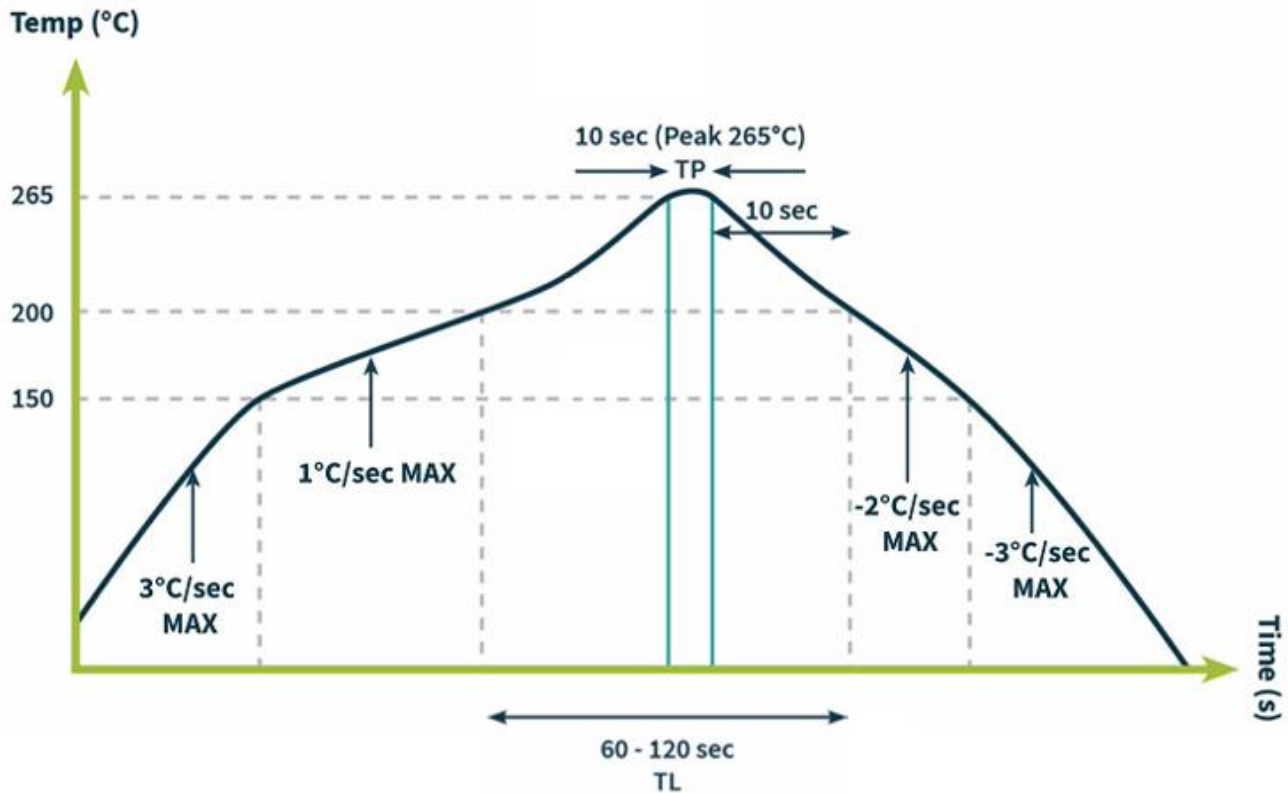

Smaller components are typically mounted on the first pass, however, we do advise mounting the PCS.06.A when placing larger components on the board during subsequent reflows.

Note: Soldering flux classified ROL0 under IPC J-STD-004 is recommended.

9. Application Note

The PCS.06.A antenna performance with different groundplane lengths.

9.1 Return Loss

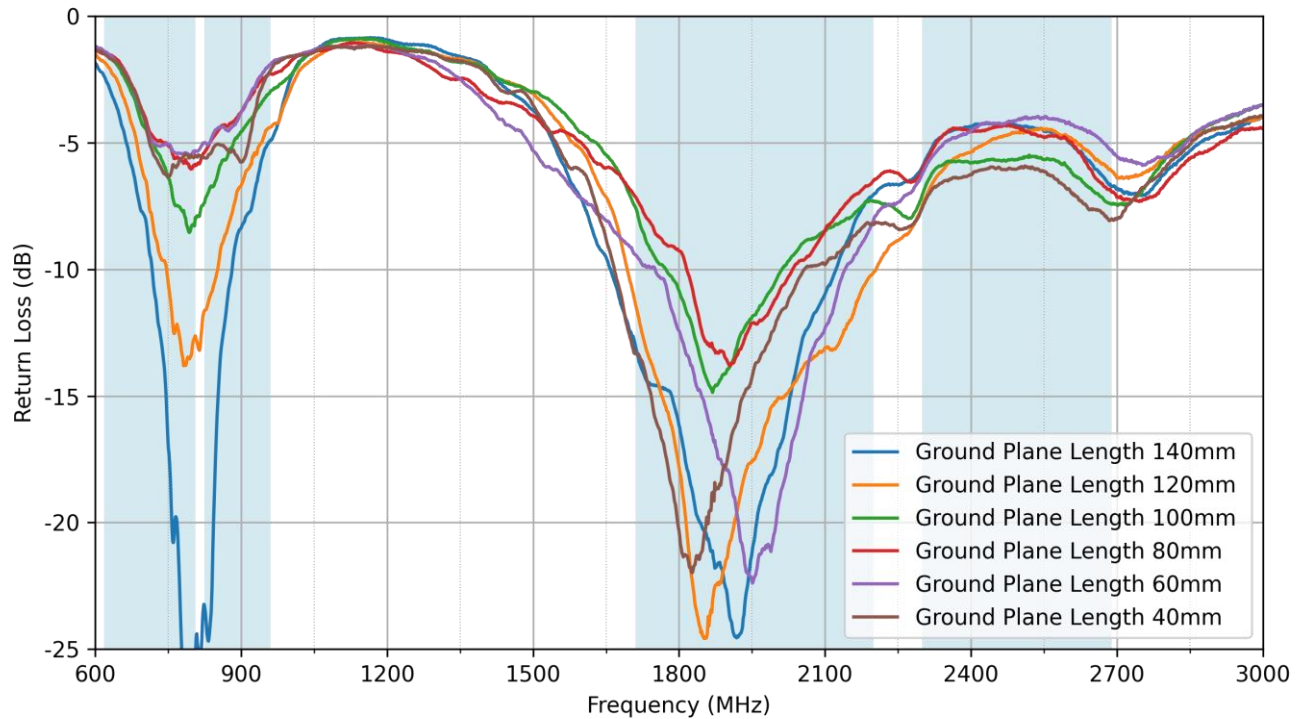

9.2 Efficiency

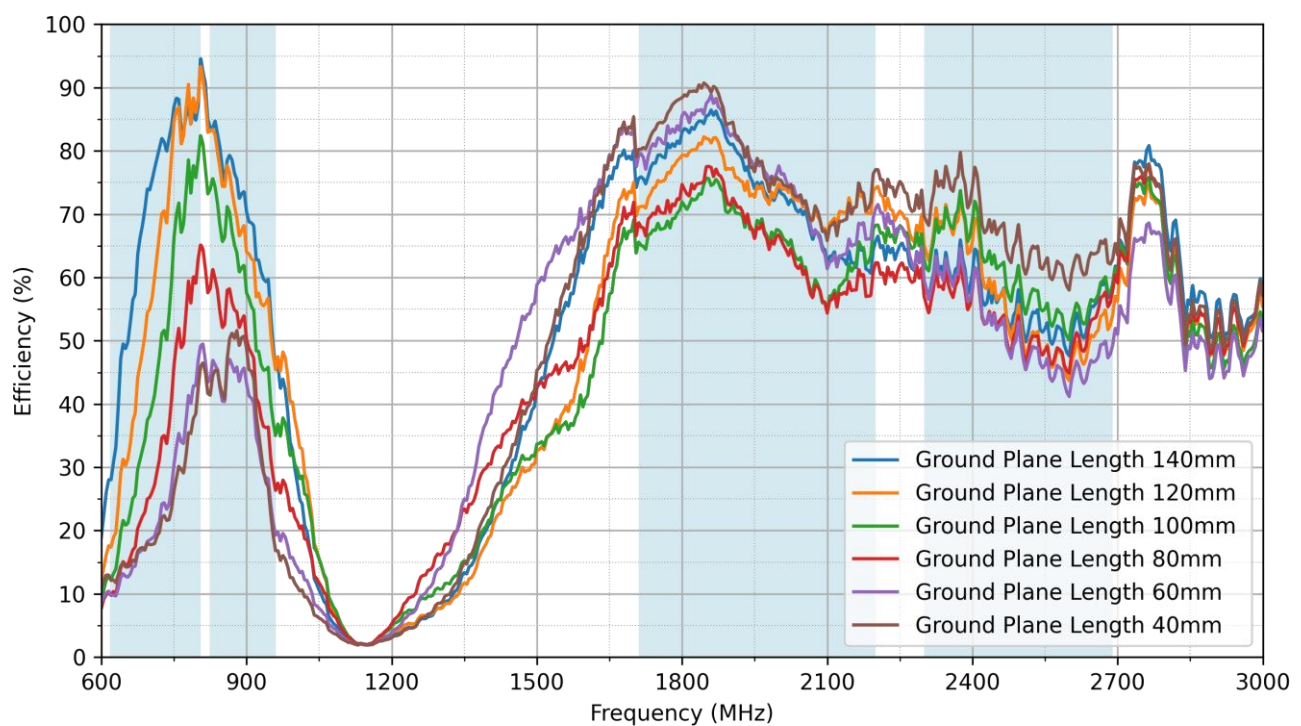

9.3 Peak Gain

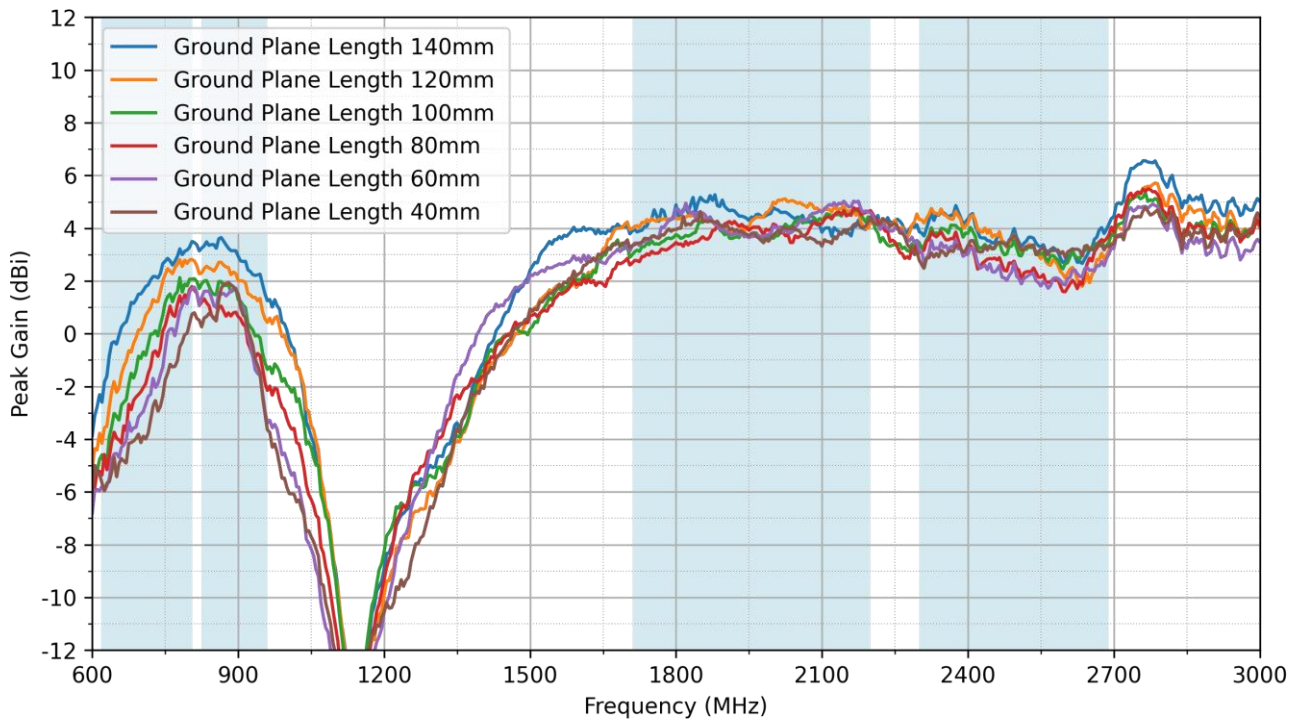

9.4 Average Gain

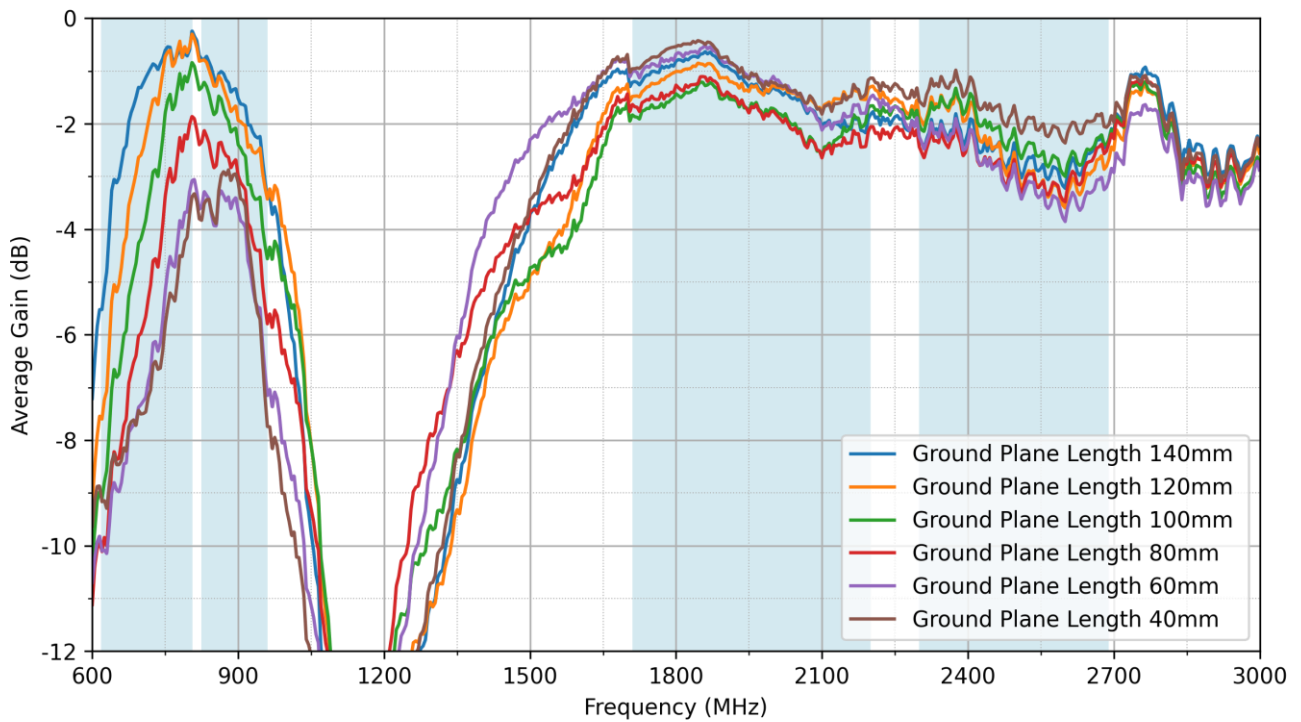

Changelog for the datasheet

SPE-13-8-070 – PCS.06.A

Revision: T (Current Version)	
Date:	2023-08-08
Changes:	Update Solder Reflow Profile
Changes Made by:	Gary West

Previous Revisions

Revision: S	
Date:	2023-04-28
Changes:	Update all test data.
Changes Made by:	Gary West

Revision: N	
Date:	2015-11-19
Changes:	Updated Imagery Reference ECR-18-8-259
Changes Made by:	Russell Meyler

Revision: R	
Date:	2022-10-18
Changes:	Update Mechanical Drawing
Changes Made by:	Gary West

Revision: M	
Date:	2018-10-23
Changes:	Did not have a description for the bottom pads, nor a diagram for connections. Amended
Changes Made by:	David Connolly

Revision: Q	
Date:	2022-07-26
Changes:	Added application note
Changes Made by:	Gary West

Revision: L	
Date:	2018-01-30
Changes:	PCN-17-8-181/A
Changes Made by:	Carol Faughnan

Revision: P	
Date:	2021-07-09
Changes:	Updated RF data.
Changes Made by:	Gary West

Revision: K	
Date:	2017-06-09
Changes:	Updated with image as per Aliss' request.
Changes Made by:	Andy Mahoney

Revision: O	
Date:	2021-02-22
Changes:	Updated datasheet template and added antenna integration guide.
Changes Made by:	Gary West

Revision: J	
Date:	2017-04-28
Changes:	Added LTE Band Table.
Changes Made by:	Peter Monahan

Revision: I	
Date:	2017-04-14
Changes:	Ammended Drawing
Changes Made by:	Jack Conroy

Revision: B	
Date:	2014-01-16
Changes:	Added Photo
Changes Made by:	Aine Doyle

Revision: H	
Date:	2017-04-04
Changes:	Added LTE Band Table.
Changes Made by:	Peter Monahan

Revision: A (First Release)	
Date:	
Changes:	First Release
Changes Made by:	Technical Writer

Revision: G	
Date:	2017-03-03
Changes:	Updated to include disclaimer, revised packaging as per PCN and general cleaning.
Changes Made by:	Andy Mahoney

Revision: F	
Date:	2015-04-26
Changes:	Comments from John
Changes Made by:	Aine Doyle

Revision: E	
Date:	2015-06-30
Changes:	Added Packaging
Changes Made by:	Aine Doyle

Revision: D	
Date:	2015-05-19
Changes:	Updated Footprint
Changes Made by:	Aine Doyle

Revision: C	
Date:	2014-03-02
Changes:	Added Product Name
Changes Made by:	Aine Doyle



www.taoglas.com

