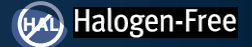

## EPC2071 – Enhancement Mode Power Transistor

 $V_{DS}$ , 100 V $R_{DS(on)}$ , 1.7 mΩ typical, 2.2 mΩ max $I_D$ , 64 A

Revised November 26, 2024

Gallium Nitride's exceptionally high electron mobility and low temperature coefficient allows very low  $R_{DS(on)}$ , while its lateral device structure and majority carrier diode provide exceptionally low  $Q_G$  and zero  $Q_{RR}$ . The end result is a device that can handle tasks where very high switching frequency, and low on-time are beneficial as well as those where on-state losses dominate.

**Application Notes:**

- Easy-to-use and reliable gate
- Gate Drive ON = 5–5.25 V typical, OFF = 0 V (negative voltage not needed)
- Recommended dead time (half bridge circuit)  $\leq 30$  ns for best efficiency
- Top of FET (back side) is electrically connected to source

**Questions:**

Ask a GaN Expert

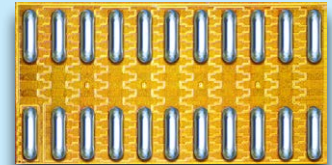

Die Size: 4.45 x 2.3 mm

EPC2071 eGaN® FETs are supplied only in passivated die form with solder bars.

**Applications**

- 48 V DC-DC converters
- BLDC motor drives
- Sync rectification for AC/DC and DC-DC
- Point of load converters
- Solar converters
- Lidar
- eMobility

**Benefits**

- Ultra high efficiency
- No reverse recovery
- Ultra low  $Q_G, Q_{GD}, Q_{OSS}$
- Ultra low  $R_{DS(on)}$
- Ultra small footprint

Scan QR code or click link below for more information including reliability reports, device models, demo boards!



<https://l.ead.me/EPC2071>

**Maximum Ratings**

PARAMETER		VALUE	UNIT
$V_{DS}$	Drain-to-Source Voltage (Continuous)	100	V
$V_{DS(tr)}$	Drain-to-Source Voltage (Repetitive Transient) <sup>(1)</sup>	120	
$I_D$	Continuous ( $T_A = 25^\circ\text{C}$ )	64	A
	Pulsed ( $25^\circ\text{C}, T_{PULSE} = 10 \mu\text{s}$ )	467	
	Pulsed ( $125^\circ\text{C}, T_{PULSE} = 10 \mu\text{s}$ )	374	
$V_{GS}$	Gate-to-Source Voltage	6	V
	Gate-to-Source Voltage	-4	
$T_J$	Operating Temperature	-40 to 150	$^\circ\text{C}$
$T_{STG}$	Storage Temperature	-40 to 150	

<sup>(1)</sup> Pulsed repetitively, duty cycle factor ( $DC_{Factor}$ )  $\leq 1\%$ ;  
See Figure 13 and Reliability Report Phase 16, Section 3.2.6

**Thermal Characteristics**

PARAMETER		TYP	UNIT
$R_{\theta JC}$	Thermal Resistance, Junction-to-Case (Case TOP)	0.4	$^\circ\text{C}/\text{W}$
$R_{\theta JB}$	Thermal Resistance, Junction-to-Board (Case BOTTOM)	1.5	
$R_{\theta JA\_JEDEC}$	Thermal Resistance, Junction-to-Ambient (using JEDEC 51-2 PCB)	59	
$R_{\theta JA\_EVB}$	Thermal Resistance, Junction-to-Ambient (using EPC90146 EVB)	31	

**Static Characteristics ( $T_J = 25^\circ\text{C}$  unless otherwise stated)**

PARAMETER		TEST CONDITIONS	MIN	TYP	MAX	UNIT
$BV_{DSS}$	Drain-to-Source Voltage	$V_{GS} = 0 \text{ V}, I_D = 0.15 \text{ mA}$	100			V
$I_{DSS}$	Drain-Source Leakage	$V_{GS} = 0 \text{ V}, V_{DS} = 80 \text{ V}$		0.001	0.12	mA
$I_{GSS}$	Gate-to-Source Forward Leakage	$V_{GS} = 5 \text{ V}$		0.03	3.2	
	Gate-to-Source Forward Leakage <sup>#</sup>	$V_{GS} = 5 \text{ V}, T_J = 125^\circ\text{C}$		0.3	7.1	
	Gate-to-Source Reverse Leakage	$V_{GS} = -4 \text{ V}$		0.006	0.17	
$V_{GS(TH)}$	Gate Threshold Voltage	$V_{DS} = V_{GS}, I_D = 13 \text{ mA}$	0.7	1.3	2.5	V
$R_{DS(on)}$	Drain-Source On Resistance	$V_{GS} = 5 \text{ V}, I_D = 30 \text{ A}$		1.7	2.2	mΩ
$V_{SD}$	Source-Drain Forward Voltage <sup>#</sup>	$I_S = 0.5 \text{ A}, V_{GS} = 0 \text{ V}$		1.5		V

<sup>#</sup> Defined by design. Not subject to production test.

Dynamic Characteristics# (T<sub>j</sub> = 25°C unless otherwise stated)

PARAMETER		TEST CONDITIONS	MIN	TYP	MAX	UNIT
C <sub>ISS</sub>	Input Capacitance	V <sub>DS</sub> = 50 V, V <sub>GS</sub> = 0 V		2664	3931	pF
C <sub>RSS</sub>	Reverse Transfer Capacitance			5.4		
C <sub>OSS</sub>	Output Capacitance			878	976	
C <sub>OSS(ER)</sub>	Effective Output Capacitance, Energy Related (Note 1)	V <sub>DS</sub> = 0 to 50 V, V <sub>GS</sub> = 0 V		1058		
C <sub>OSS(TR)</sub>	Effective Output Capacitance, Time Related (Note 2)			1422		
R <sub>G</sub>	Gate Resistance			0.3		Ω
Q <sub>G</sub>	Total Gate Charge	V <sub>DS</sub> = 50 V, V <sub>GS</sub> = 5 V, I <sub>D</sub> = 30 A		18	26	nC
Q <sub>GS</sub>	Gate-to-Source Charge	V <sub>DS</sub> = 50 V, I <sub>D</sub> = 30 A		6.0		
Q <sub>GD</sub>	Gate-to-Drain Charge			1.8		
Q <sub>G(TH)</sub>	Gate Charge at Threshold			4.5		
Q <sub>OSS</sub>	Output Charge	V <sub>DS</sub> = 50 V, V <sub>GS</sub> = 0 V		71	82	
Q <sub>RR</sub>	Source-Drain Recovery Charge (Note 3)			0		

# Defined by design. Not subject to production test.

All measurements were done with substrate connected to source.

Note 1: C<sub>OSS(ER)</sub> is a fixed capacitance that gives the same stored energy as C<sub>OSS</sub> while V<sub>DS</sub> is rising from 0 to 50% BV<sub>DSS</sub>.

Note 2: C<sub>OSS(TR)</sub> is a fixed capacitance that gives the same charging time as C<sub>OSS</sub> while V<sub>DS</sub> is rising from 0 to 50% BV<sub>DSS</sub>.

Note 3: GaN FET do not have an anti-parallel body diode, and hence do not exhibit reverse recovery. However they can operate in the third quadrant, and their reverse conduction characteristic is shown in Figure 8.

Figure 1: Typical Output Characteristics at 25°C\*

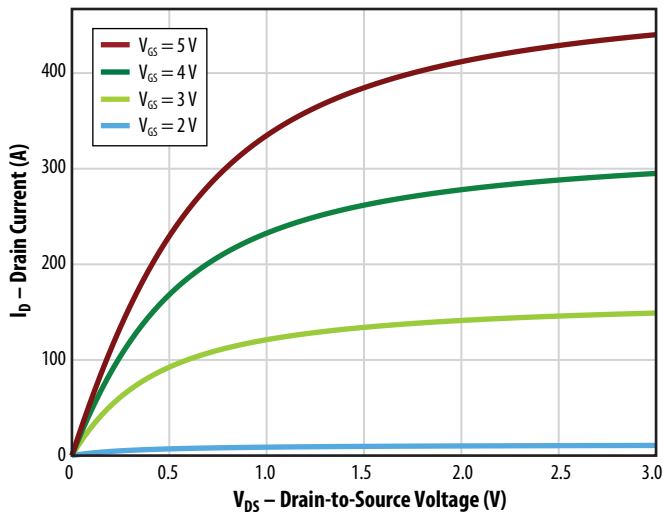

Figure 2: Typical Transfer Characteristics\*

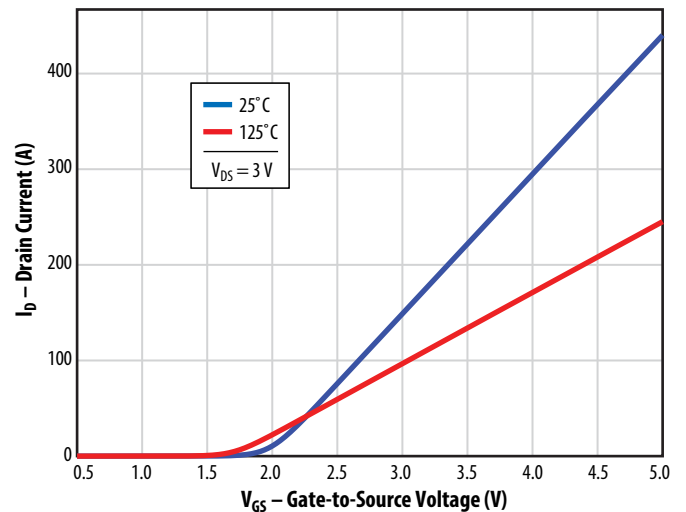

Figure 3: Typical R<sub>DS(on)</sub> vs. V<sub>GS</sub> for Various Drain Currents

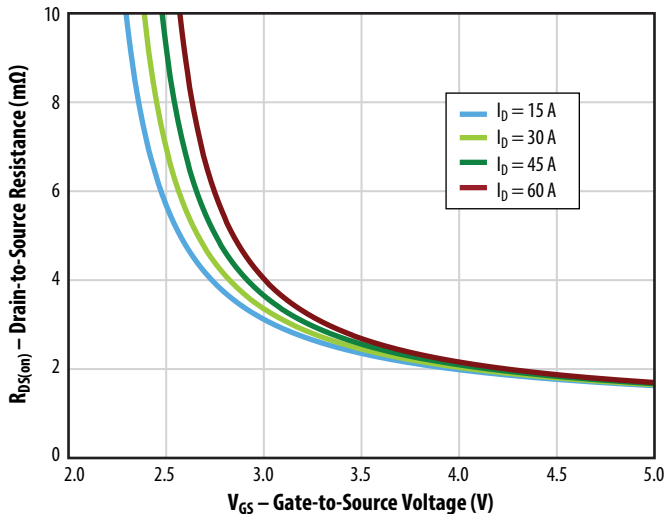
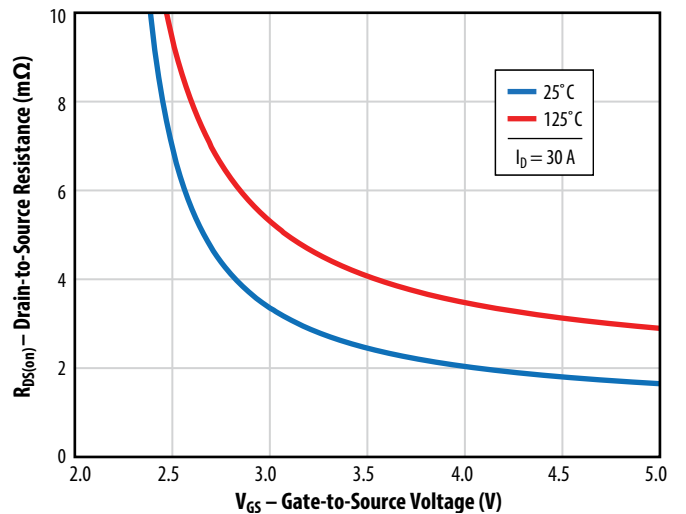

Figure 4: Typical R<sub>DS(on)</sub> vs. V<sub>GS</sub> for Various Temperatures



\* Generated based on a pulse width of 300 μs.

Figure 5a: Typical Capacitance (Linear Scale)

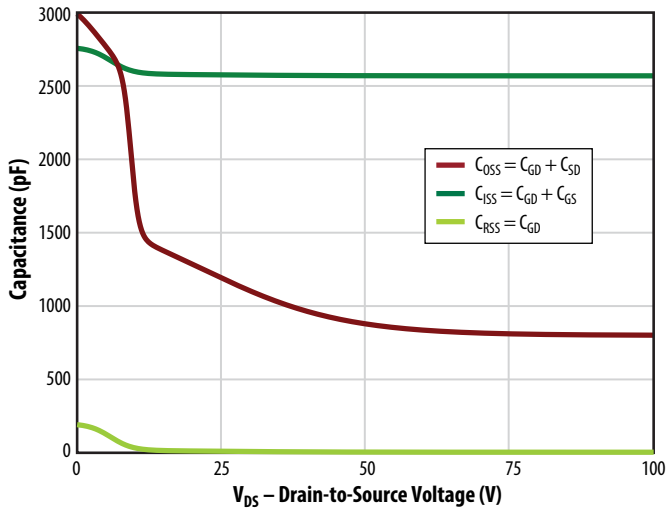

Figure 5b: Typical Capacitance (Log Scale)

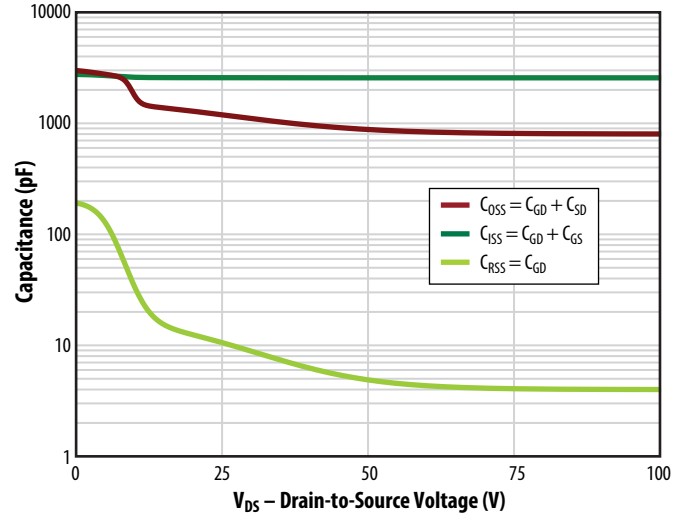

Figure 6: Typical Output Charge and C\_OSS Stored Energy

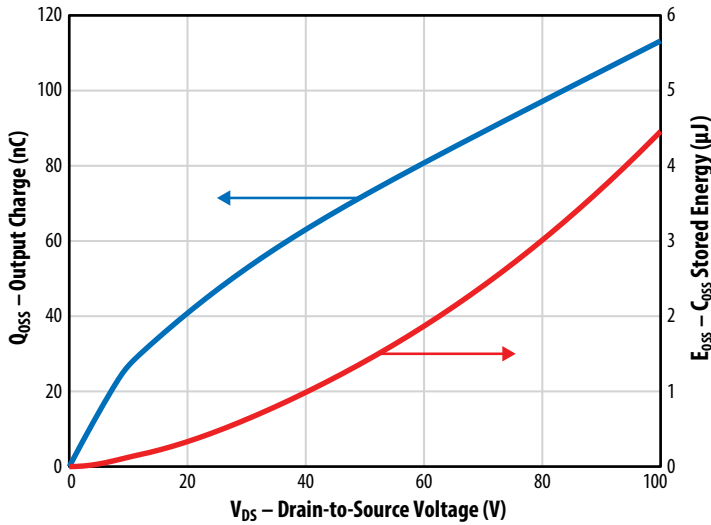

Figure 7: Typical Gate Charge

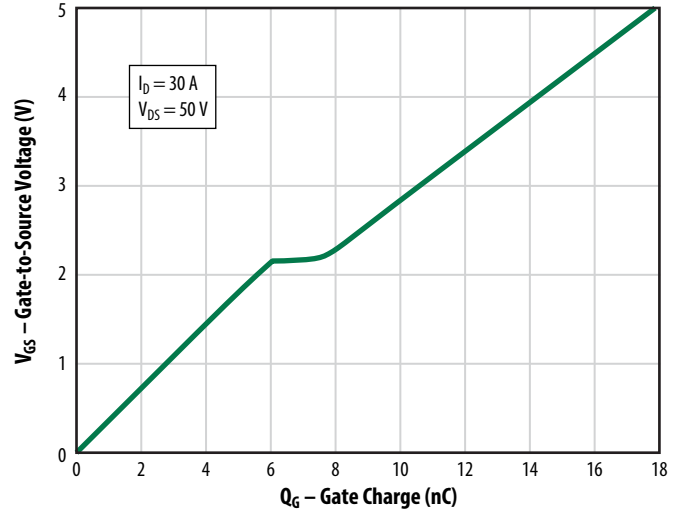

Figure 8: Typical Reverse Drain-Source Characteristics\*

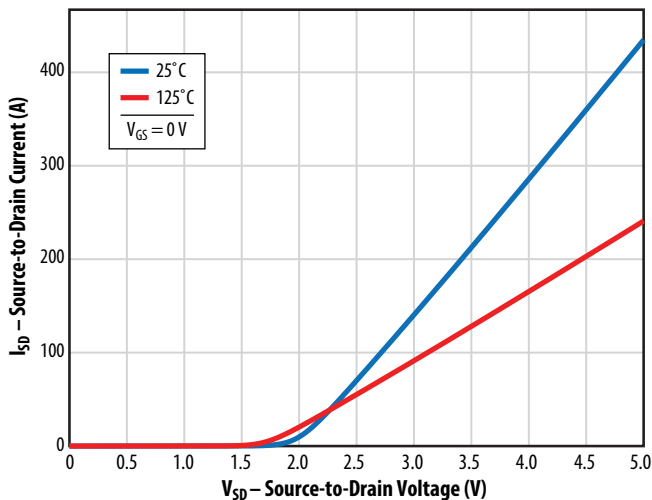
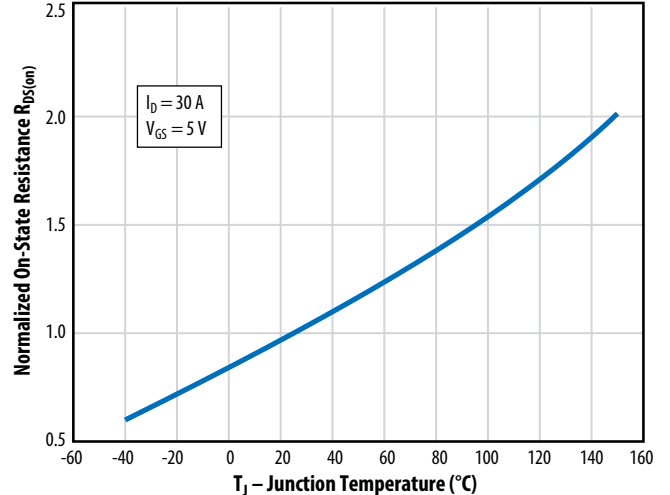

Figure 9: Typical Normalized On-State Resistance vs. Temp.



Note: Negative gate drive voltage increases the reverse drain-source voltage.

EPC recommends 0 V for OFF.

\* Generated based on a pulse width of 300 μs.

Figure 10: Typical Normalized Threshold Voltage vs. Temp.

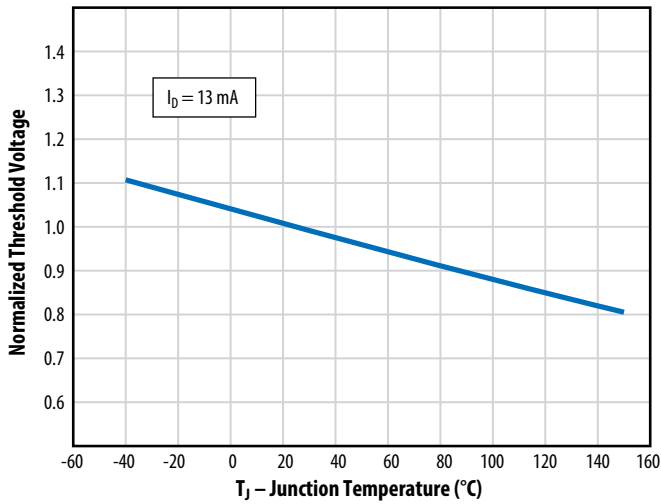

Figure 11: Safe Operating Area

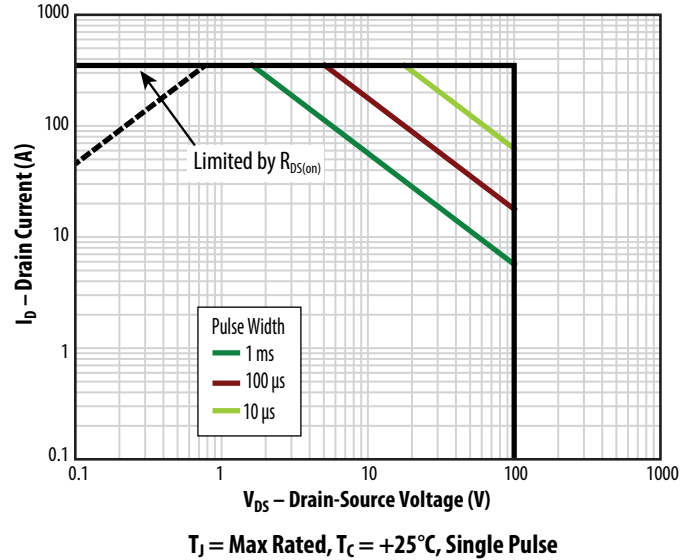

Figure 12: Typical Transient Thermal Response Curves

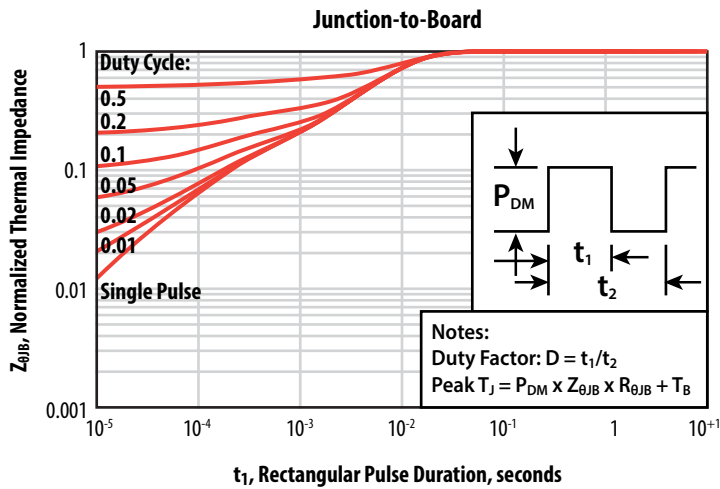
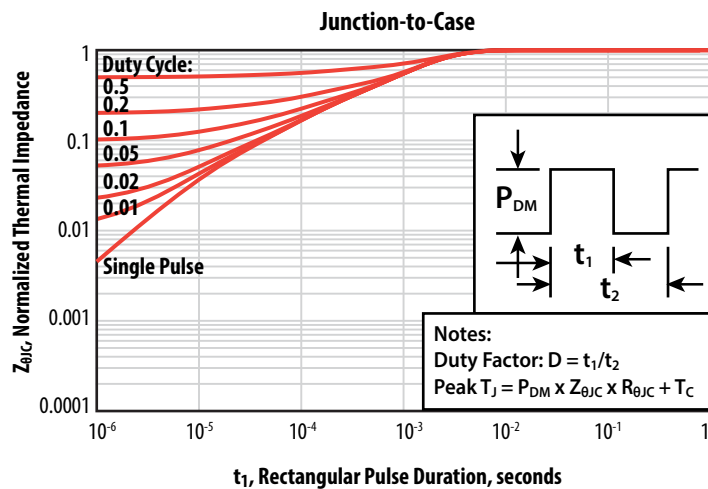
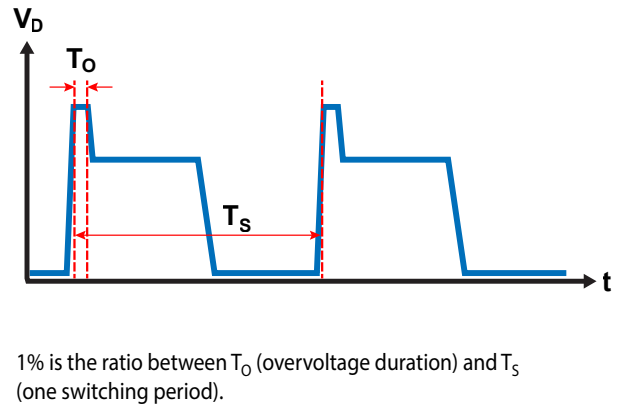

Figure 13: Duty Cycle Factor ( $DC_{Factor}$ ) Illustration for Repetitive Overvoltage Specification



## LAYOUT CONSIDERATIONS

GaN transistors generally behave like power MOSFETs, but at much higher switching speeds and power densities, therefore layout considerations are very important, and care must be taken to minimize layout parasitic inductances. The recommended design utilizes the first inner layer as a power loop return path. This return path is located directly beneath the top layer's power loop allowing for the smallest physical loop size. This method is also commonly referred to as flux cancellation. Variations of this concept can be implemented by placing the bus capacitors either next to the high side device, or next to the low side device, or between the low and high side devices, but in all cases the loop is closed using the first inner layer right beneath the devices.

A similar concept is also used for the gate loop, with the return gate loop located directly under the turn ON and OFF gate resistors.

Furthermore, to minimize the common source inductance between power and gate loops, the power and gate loops are laid out perpendicular to each other, and a via next to the source pad closest to the gate pad is used as Kelvin connection for the gate driver return path.

The [EPC90146 Quick Start Guide – 100 V, 40 A Half-Bridge Development Board Using EPC2071](#) implements our recommended vertical inner layout.

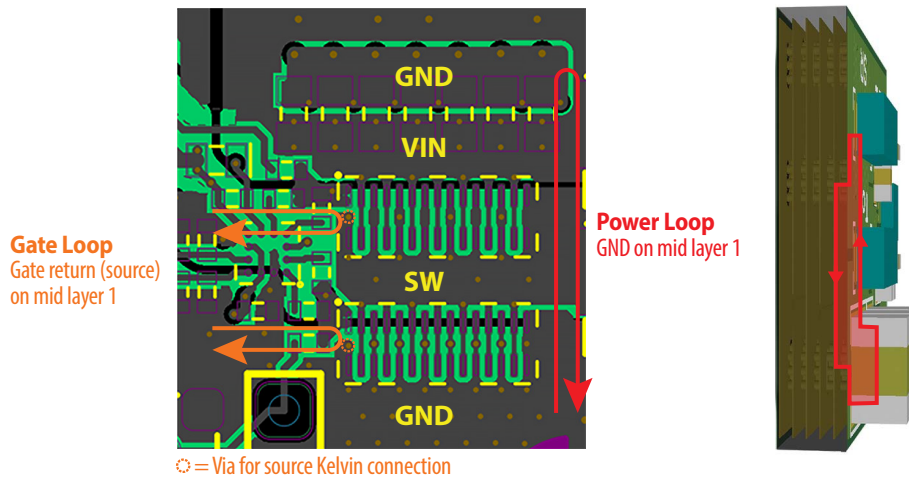

Figure 13: Inner vertical layout for power and gate loops from EPC90146

Detailed recommendations on layout can be found on EPC's website: [Optimizing PCB Layout with eGaN FETs.pdf](#)

## TYPICAL SWITCHING BEHAVIOR

The following typical switching waveforms are captured in these conditions:

- [EPC90146 – 100 V, 40 A Half-bridge Development Board using EPC2071](#)
- Gate driver: uP1966E with 0.4  $\Omega$ /0.7  $\Omega$  pull-down/pull-up resistance
- External  $R_G(\text{ON}) = 0 \Omega$ ,  $R_G(\text{OFF}) = 0 \Omega$
- $V_{\text{IN}} = 64 \text{ V}$ ,  $I_L = 32 \text{ A}$

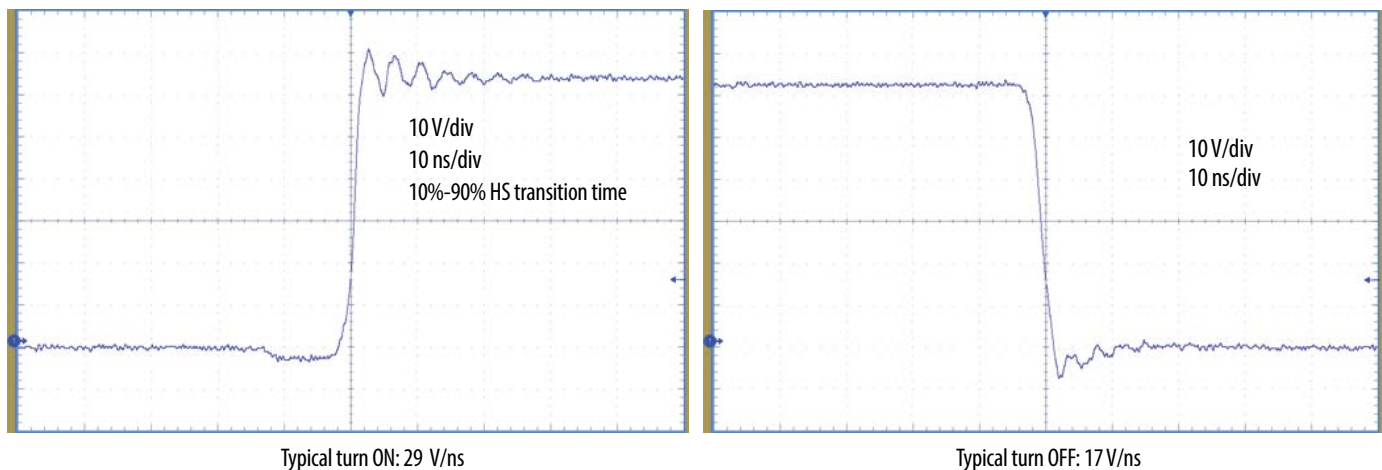

Figure 14: Typical half-bridge voltage switching waveforms

See the [EPC90146 Quick Start Guide \(QSG\)](#) for more information.

## TYPICAL THERMAL CONCEPT

The EPC2071 can take advantage of dual sided cooling to maximize its heat dissipation capabilities in high power density designs. **Note that the top of EPC FETs are connected to source potential, so for half-bridge topologies the Thermal Interface Material (TIM) needs to provide electrical isolation to the heatsink.**

Recommended best practice thermal solutions are covered in detail in [How2AppNote012 - How to Get More Power Out of an eGaN Converter.pdf](#).

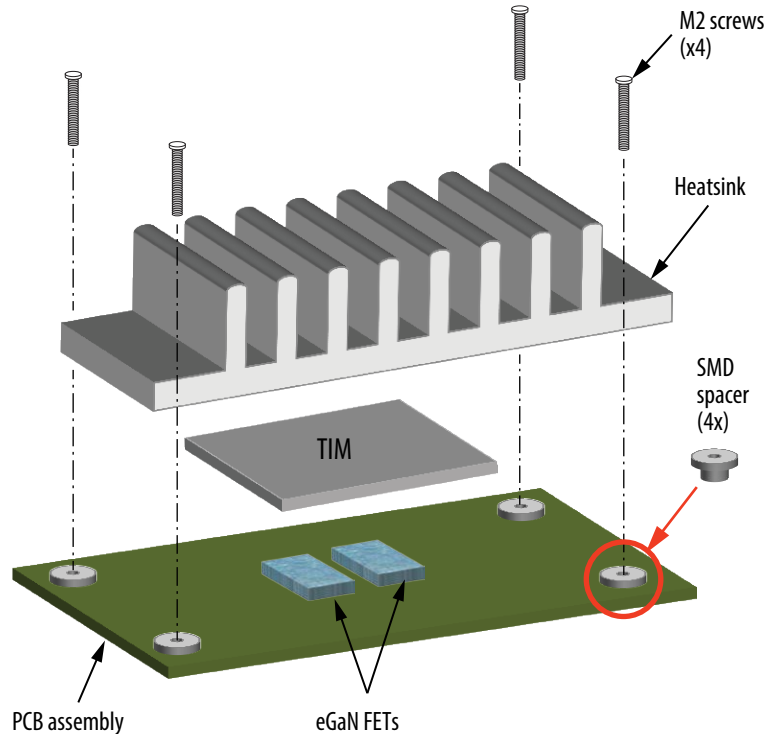

Figure 15: Exploded view of heatsink assembly using screws

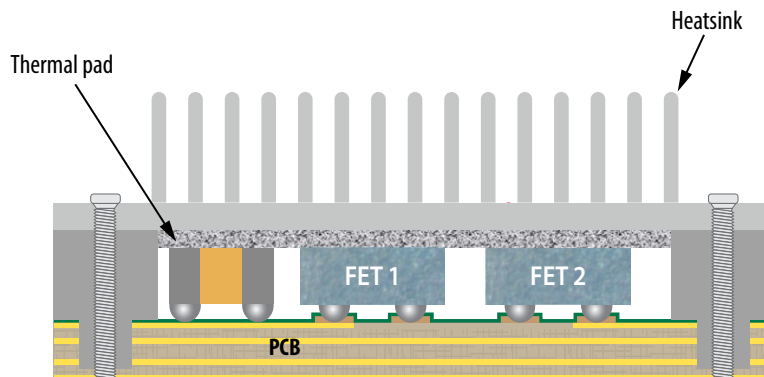

Figure 16: A cross-section image of dual sided thermal solution

**Note: Connecting the heatsink to ground is recommended and can significantly improve radiated EMI**

The thermal design can be optimized by using the [GaN FET Thermal Calculator](#) on EPC's website.

**TAPE AND REEL CONFIGURATION**

8 mm pitch, 12 mm wide tape on 7" reel

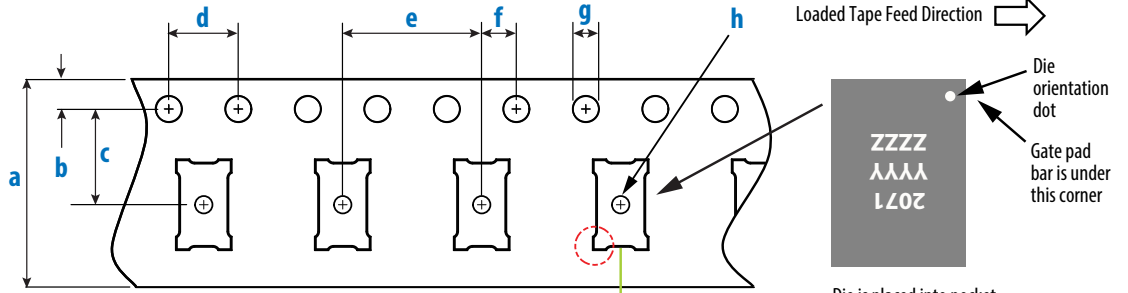
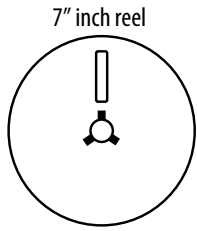

EPC2071 (Note 1)	Dimension (mm)		
	Target	MIN	MAX
a	12.00	11.90	12.30
b	1.75	1.65	1.85
c (Note 2)	5.50	5.45	5.55
d	4.00	3.90	4.10
e	8.00	7.90	8.10
f (Note 2)	2.00	1.95	2.05
g	1.50	1.50	1.60
h	1.00	0.95	1.05
i	1.02		

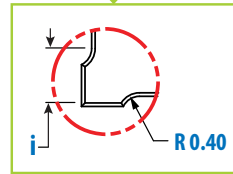

Note 1: MSL 1 (moisture sensitivity level 1) classified according to IPC/ JEDEC industry standard.

Note 2: Pocket position is relative to the sprocket hole measured as true position of the pocket, not the pocket hole.

**DIE MARKINGS**

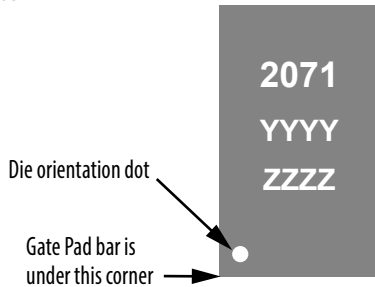

Part Number	Laser Markings		
	Part # Marking Line 1	Lot_Date Code Marking Line 2	Lot_Date Code Marking Line 3
EPC2071	2071	YYYY	ZZZZ

**DIE OUTLINE**

Solder Bump View

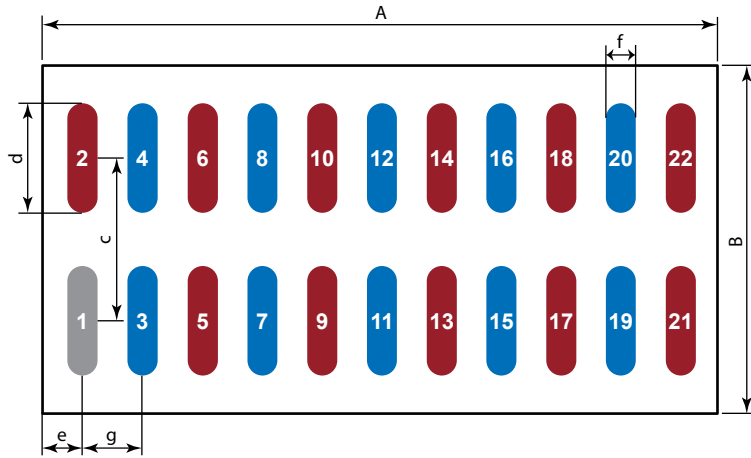

Side View

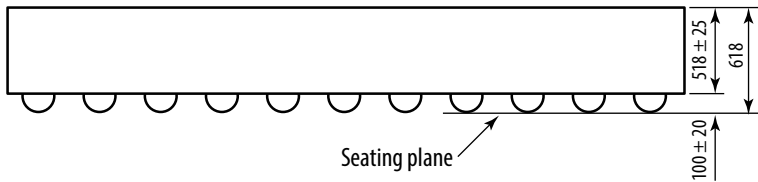

**Solder bump material:**

Solder Alloy Sn/1.8Ag : IPC/JEDEC J-STD-609 solder alloy e-code : e2

DIM	Micrometers		
	MIN	Nominal	MAX
A	4420	4450	4480
B	2270	2300	2330
c		1330	
d		720	
e		225	
f		200	
g		400	

Pad 1 is Gate;

Pads 2, 5, 6, 9, 10, 13, 14, 17, 18, 21, 22 are Source;

Pads 3, 4, 7, 8, 11, 12, 15, 16, 19, 20 are Drain;

\*Substrate (top side) connected to Source

**RECOMMENDED LAND PATTERN**  
(units in  $\mu\text{m}$ )

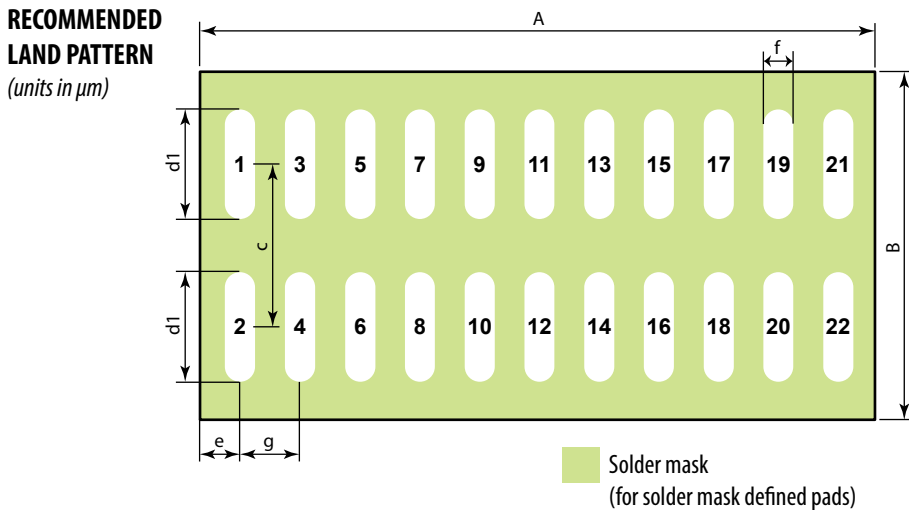

DIM	Micrometers
A	4450
B	2300
c	1330
d1	700
e	225
f	180
g	400

Pad 1 is Gate;

Pads 2, 5, 6, 9, 10, 13, 14, 17, 18, 21, 22 are Source;

Pads 3, 4, 7, 8, 11, 12, 15, 16, 19, 20 are Drain

**RECOMMENDED STENCIL DRAWING**  
(units in  $\mu\text{m}$ )

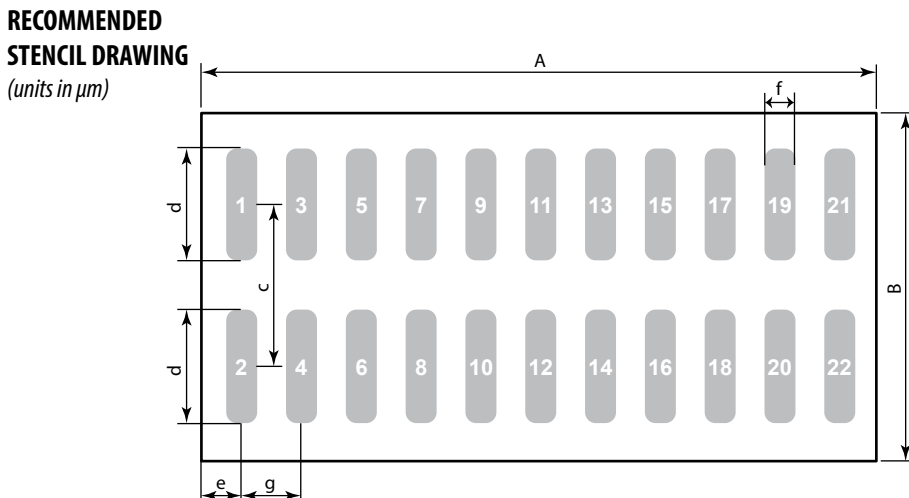

DIM	Micrometers
A	4450
B	2300
c	1330
d	700
e	225
f	180
g	400

Recommended stencil should be 4 mil (100  $\mu\text{m}$ ) thick, must be laser cut, openings per drawing.

The corner has a radius of R60  $\mu\text{m}$ .

Intended for use with SAC305 Type 4 solder, reference 88.5% metals content.

**ADDITIONAL RESOURCES AVAILABLE**

Solder mask defined pads are recommended for best reliability.

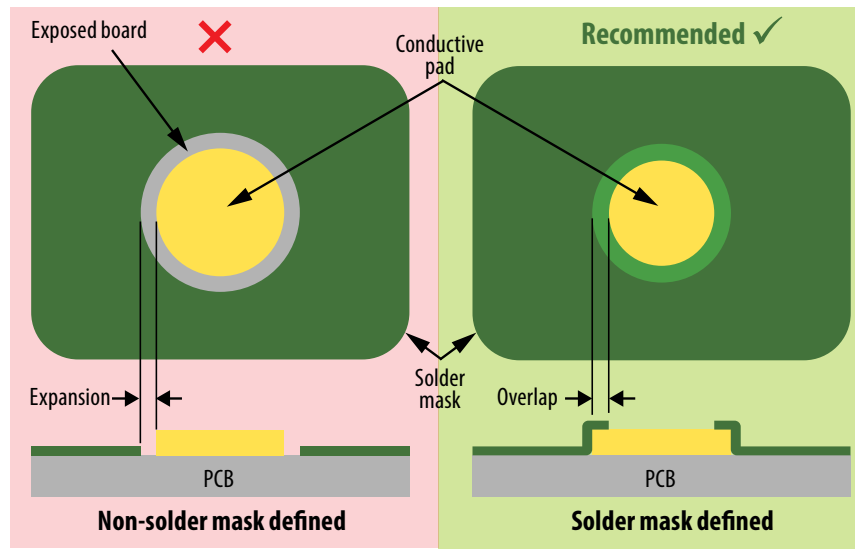

Figure 17: Solder mask defined versus non-solder mask defined pad

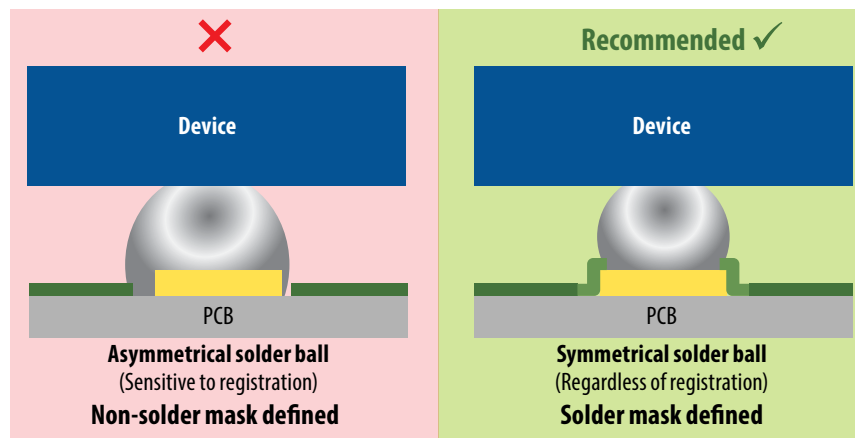

Figure 18: Effect of solder mask design on the solder ball symmetry

- Assembly resources – [https://epc-co.com/epc/Portals/0/epc/documents/product-training/Appnote\\_GaNassembly.pdf](https://epc-co.com/epc/Portals/0/epc/documents/product-training/Appnote_GaNassembly.pdf)
- Library of Altium footprints for production FETs and ICs – <https://epc-co.com/epc/documents/altium-files/EPC%20Altium%20Library.zip>  
(for preliminary device Altium footprints, contact EPC)

Efficient Power Conversion Corporation (EPC) reserves the right to make changes without further notice to any products herein to improve reliability, function or design. EPC does not assume any liability arising out of the application or use of any product or circuit described herein; neither does it convey any license under its patent rights, nor the rights of others.

eGaN® is a registered trademark of Efficient Power Conversion Corporation.

EPC Patent Listing: <https://epc-co.com/epc/about-epc/patents>

Information subject to change without notice.