

RPM7050

MIL/COTS AC, SINGLE PHASE 1U HEIGHT EMI POWER LINE FILTER

FEATURES

- » Rated currents include **5A, 10A, 20A, and 30A**
- » Dual Stage Line Filter
- » Available with **S** (studs)
- » Agency Approved to RoHS
- » Y-cap value can be adjusted to fit specification



ELECTRICAL SCHEMATIC

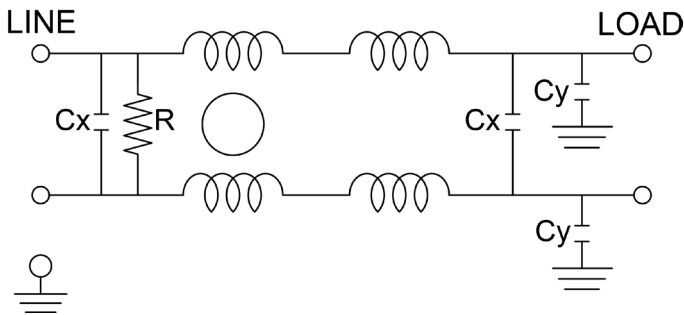

SPECIFICATIONS

OPERATING FREQUENCY	50/60/400 Hz
MAX. OPERATING VOLTAGE	300 VAC +10%
AMBIENT TEMPERATURE	-40 TO 70°C
CLIMATIC CATEGORY	40/100/21
TERMINALS (-T)	STUDS: 5-30A (M5)

TYP. WEIGHT, LBS (KG)	1.5 (0.8)
-----------------------	-----------

TYPICAL LEAKAGE CURRENT

@ 250 VAC 60 Hz	0 - 3.50 mA Max.
-----------------	------------------

HIPOT RATINGS

LINE TO GROUND	1800 VDC
----------------	----------

TYPICAL APPLICATIONS

- ✓ Mil-461/ DO-160

NOTE:

- ✓ Call for other termination types (e.g. Circular Mil-Connectors, etc.) Leakage current is determined by the line to ground capacitors in the filter. The capacitors can be easily varied to match the system leakage requirements.

HOW TO ORDER

RPM7050 - Y - Z

Z = TERMINAL (-T)
X = RATED CURRENT

RPM7050=FILTER SERIES

NOTE: USE ANY COMBINATION OF -X (AMPS) WITH ANY -Y RATINGS

E.G. **RPM7050-5-S** (5AMPS)

For **X** and **Y** options see product specification table.

RPM7050

MIL/COTS AC, SINGLE PHASE 1U HEIGHT EMI POWER LINE FILTER

MODEL NO.	RATED CURRENT, A @ 40° C	LEAKAGE CURRENT, mA @ 250V AC, 60 Hz	TERMINAL OPTIONS			MAX. DIMENSIONS" (MM)		
			(QD) INPUT/ OUTPUT	(W) INPUT/ OUTPUT	(S) INPUT/ OUTPUT	WIDTH	(LENGTH)	HEIGHT
RPM7050-5-S	5	3.50			✓	4.13"(105)	5.73"(146)	1.54"(39)
RPM7050-10-S	10	3.50			✓	4.13"(105)	5.73"(146)	1.54"(39)
RPM7050-20-S	20	3.50			✓	4.13"(105)	5.73"(146)	1.54"(39)
RPM7050-30-S	30	3.50			✓	4.13"(105)	5.73"(146)	1.54"(39)

RPM7050 MECHANICAL OUTLINES (MM)

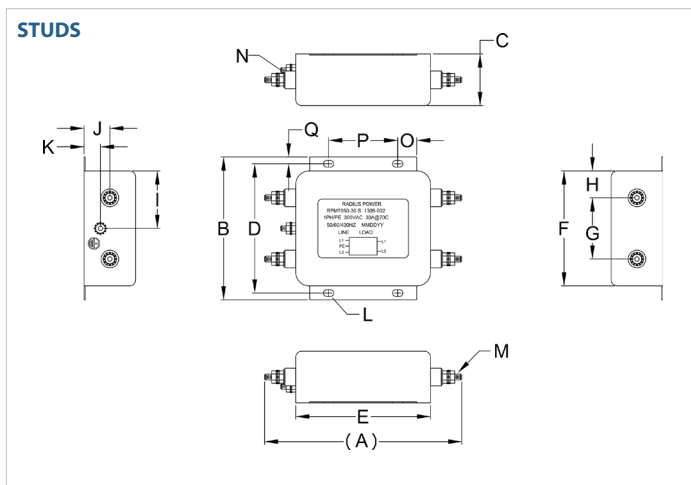

SERIES	(A)	B	C	D	E	F	G	H	I	J	K	L	M	N	O	P	Q
STUDS	5.73" (146)	4.13" (105)	1.54" (39)	3.74" (95)	3.96" (101)	3.33" (85)	1.77" (45)	0.78" (20)	1.66" (42)	0.75" (19)	0.47" (12)	Ø 0.29"x0.19", 4x (Ø 7.6x5.0, 4x)	STUD, M5, 4x	STUD, GND, M5	0.55" (14)	2.01" (51)	0.20" (5)

TYPICAL TOLERANCE: +/-0.02" (0.50MM)

RPM7050

MIL/COTS **AC**, SINGLE PHASE 1U HEIGHT EMI POWER LINE FILTER

TYPICAL INSERTION LOSS, dB (50/50 Ohm)

Amps	Freq (MHz)	0.15	0.5	1.0	10	30
5	CM (dB)	32	50	50	45	30
	DM (dB)	42	60	60	40	30
10	CM (dB)	32	50	50	45	30
	DM (dB)	42	60	60	40	30
20	CM (dB)	32	50	50	45	30
	DM (dB)	42	60	60	40	30
30	CM (dB)	32	50	50	45	30
	DM (dB)	42	60	60	40	30