

STEALTH™ Diode

30 A, 1200 V

ISL9R30120G2

Description

The ISL9R30120G2 is a STEALTH diode optimized for low loss performance in high frequency hard switched applications. The STEALTH family exhibits low reverse recovery current (I_{RR}) and exceptionally soft recovery under typical operating conditions.

This device is intended for use as a free wheeling or boost diode in power supplies and other power switching applications. The low I_{RR} and short ta phase reduce loss in switching transistors. The soft recovery minimizes ringing, expanding the range of conditions under which the diode may be operated without the use of additional snubber circuitry. Consider using the STEALTH diode with an SMPS IGBT to provide the most efficient and highest power density design at lower cost.

Features

- Stealth Recovery $t_{rr} = 269$ ns (@ $I_F = 30$ A)
- Max Forward Voltage, $V_F = 3.3$ V (@ $T_C = 25^\circ\text{C}$)
- 1200 V Reverse Voltage and High Reliability
- Avalanche Energy Rated
- This Device is Pb-Free and is RoHS Compliant

Applications

- Switch Mode Power Supplies
- Hard Switched PFC Boost Diode
- UPS Free Wheeling Diode
- Motor Drive FWD
- SMPS FWD
- Snubber Diode



ON Semiconductor®

www.onsemi.com

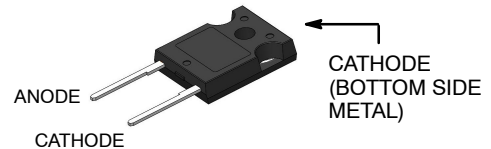

TO-247-2LD
CASE 340CL

SYMBOL



MARKING DIAGRAM

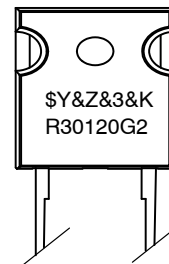

\$Y	= ON Semiconductor Logo
&Z	= Assembly Plant Code
&3	= Numeric Date Code
&K	= Lot Code
R30120G2	= Specific Device Code

ORDERING INFORMATION

See detailed ordering and shipping information on page 2 of this data sheet.

ISL9R30120G2

DEVICE MAXIMUM RATINGS (T_C = 25°C unless otherwise noted)

Characteristic	Symbol	Value	Unit
Repetitive Peak Reverse Voltage	V _R RM	1200	V
Working Peak Reverse Voltage	V _R WM	1200	V
DC Blocking Voltage	V _R	1200	V
Average Rectified Forward Current (T _C = 80°C)	I _{F(AV)}	30	A
Repetitive Peak Surge Current (20 kHz Square Wave)	I _F RM	70	A
Non-repetitive Peak Surge Current (Halfwave 1 Phase 60 Hz)	I _F SM	325	A
Power Dissipation	P _D	166	W
Avalanche Energy (1 A, 40 mH)	E _{AVL}	20	mJ
Operating and Storage Temperature Range	T _J , T _{STG}	-55 to +175	°C
Maximum Temperature for Soldering Leads at 0.063 in (1.6 mm) from Case for 10 s Package Body for 10 s	T _L T _{PKG}	300 260	°C °C

Stresses exceeding those listed in the Maximum Ratings table may damage the device. If any of these limits are exceeded, device functionality should not be assumed, damage may occur and reliability may be affected.

PACKAGE MARKING AND ORDERING INFORMATION

Device	Device Marking	Package	Packing Method	Tape Width	Quantity
ISL9R30120G2	R30120G2	TO-247-2LD	Tube	N/A	30

THERMAL CHARACTERISTICS

Parameter	Symbol	Value	Unit
Thermal Resistance, Junction to Case	R _{θJC}	0.75	°C/W
Thermal Resistance, Junction to Ambient	R _{θJA}	30	°C/W

ISL9R30120G2

ELECTRICAL CHARACTERISTICS (T_C = 25°C unless otherwise noted)

Parameter	Symbol	Test Conditions	Min	Typ	Max	Unit
-----------	--------	-----------------	-----	-----	-----	------

Off State Characteristics

Instantaneous Reverse Current	I _R	V _R = 1200 V	T _C = 25°C	-	-	100	μA
			T _C = 125°C	-	-	1.0	mA

On State Characteristics

Instantaneous Forward Voltage	V _F	I _F = 30 A	T _C = 25°C	-	2.8	3.3	V
			T _C = 125°C	-	2.6	3.1	V

Dynamic Characteristics

Junction Capacitance	C _J	V _R = 10 V, I _F = 0 A	-	115	-	pF
----------------------	----------------	---	---	-----	---	----

Switching Characteristics

Reverse Recovery Time	t _{rr}	I _F = 1 A, di/dt = 100 A/μs, V _R = 15 V	-	45	56	ns
		I _F = 30 A, di/dt = 100 A/μs, V _R = 15 V	-	80	100	ns
Reverse Recovery Time	t _{rr}	I _F = 30 A, di _F /dt = 200 A/μs, V _R = 780 V, T _C = 25°C	-	269	-	ns
Reverse Recovery Current	I _{rr}		-	7.5	-	A
Reverse Recovered Charge	Q _{rr}		-	930	-	nC
Reverse Recovery Time	t _{rr}		-	529	-	ns
Softness Factor (t _b /t _a)	S		-	6.2	-	-
Reverse Recovery Current	I _{rr}	I _F = 30 A, di _F /dt = 200 A/μs, V _R = 780 V, T _C = 125°C	-	11	-	A
Reverse Recovered Charge	Q _{rr}		-	3.0	-	μC
Reverse Recovery Time	t _{rr}		-	260	-	ns
Softness Factor (t _b /t _a)	S		-	4.8	-	-
Reverse Recovery Current	I _{rr}		-	30	-	A
Reverse Recovered Charge	Q _{rr}	I _F = 30 A, di _F /dt = 1000 A/μs, V _R = 780 V, T _C = 125°C	-	3.4	-	μC
Maximum di/dt During t _b	di _M /dt		-	520	-	A/μs

Product parametric performance is indicated in the Electrical Characteristics for the listed test conditions, unless otherwise noted. Product performance may not be indicated by the Electrical Characteristics if operated under different conditions.

TYPICAL PERFORMANCE CURVES

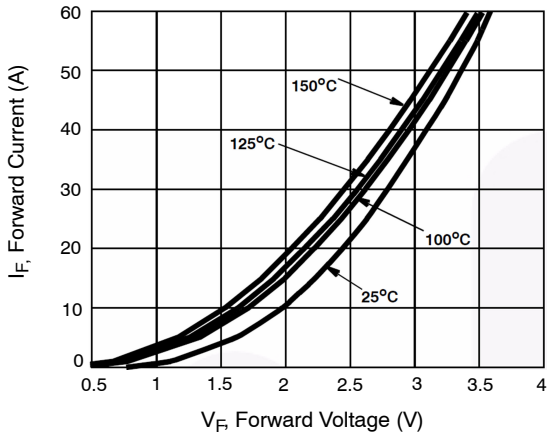

Figure 1. Forward Current vs. Forward Voltage

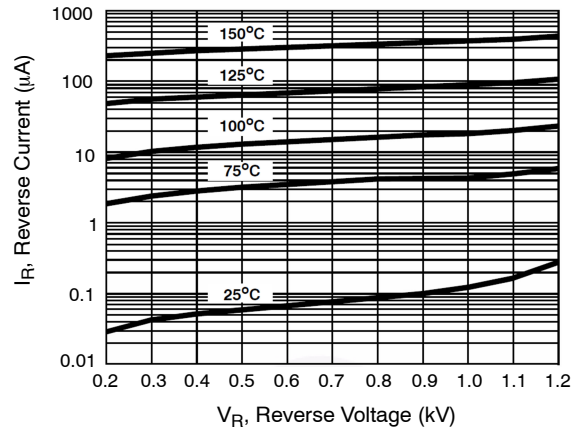

Figure 2. Reverse Current vs. Reverse Voltage

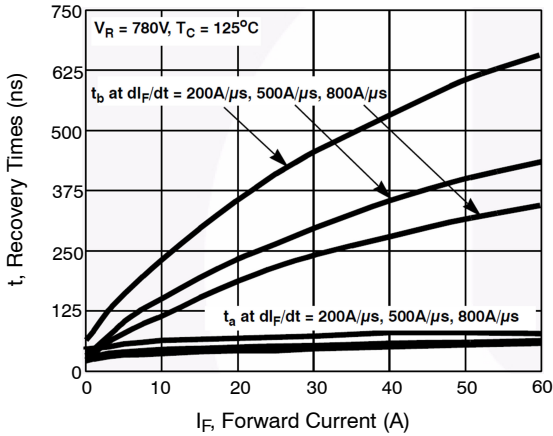

Figure 3. t_a and t_b Curves vs. Forward Current

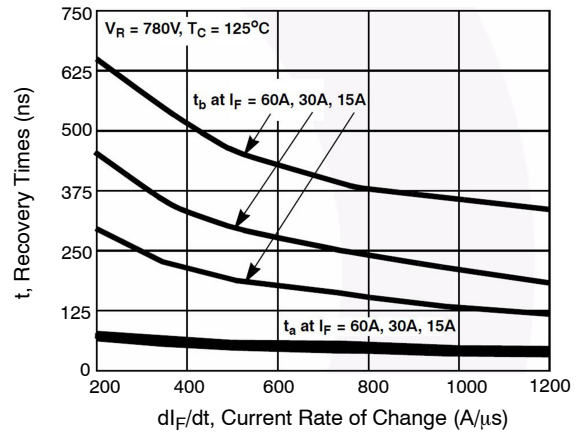

Figure 4. t_a and t_b Curves vs. dI_F/dt

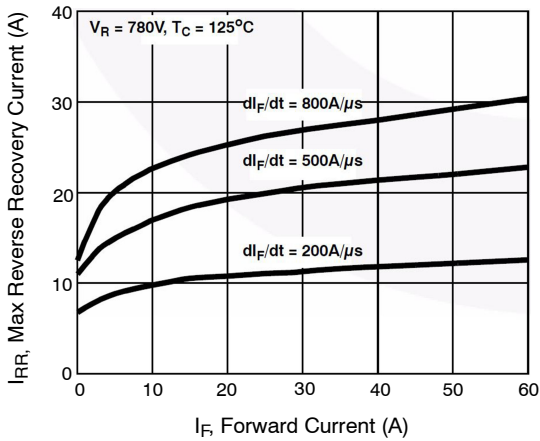

Figure 5. Maximum Reverse Recovery Current vs. Forward Current

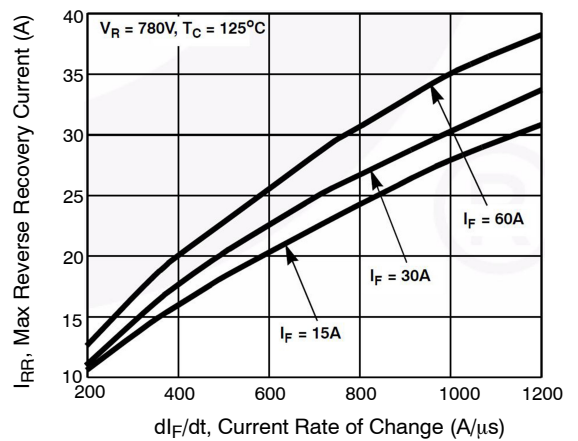

Figure 6. Maximum Reverse Recovery Current vs. dI_F/dt

TYPICAL PERFORMANCE CURVES (continued)

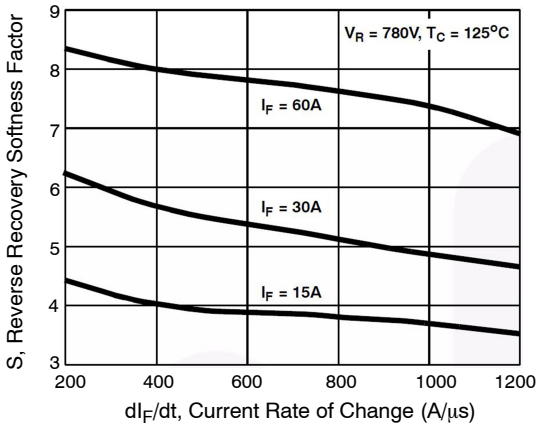

Figure 7. Reverse Recovery Softness Factor vs. dI_F/dt

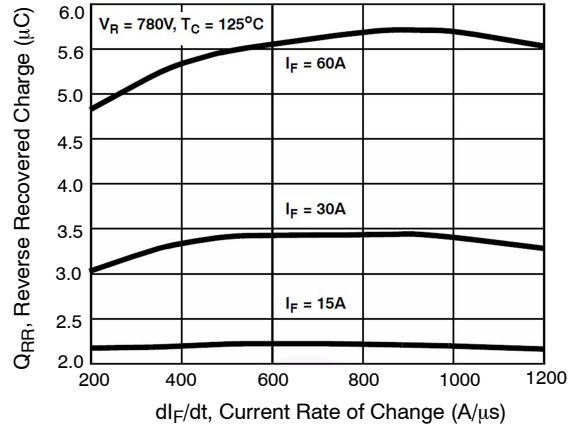

Figure 8. Reverse Recovery Charge vs. dI_F/dt

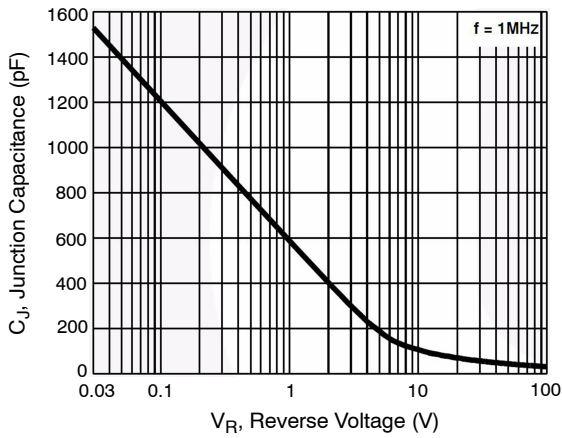

Figure 9. Junction Capacitance vs. Reverse Voltage

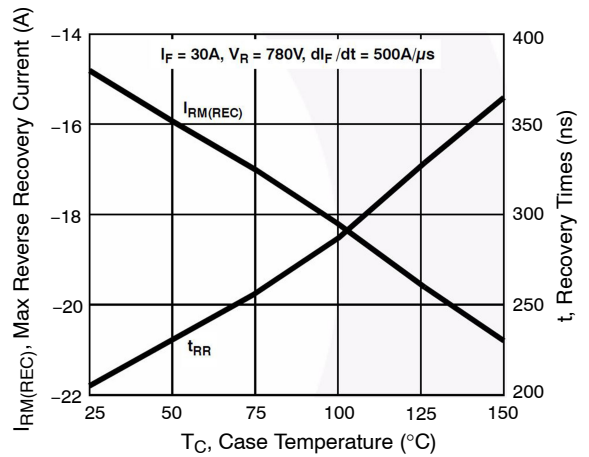

Figure 10. Maximum Reverse Recovery Current and t_{rr} vs. Case Temperature

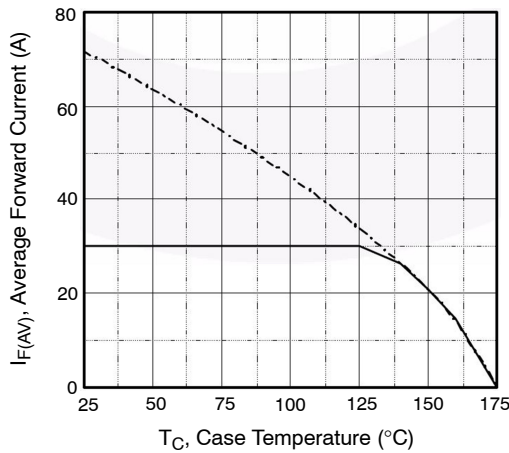

Figure 11. DC Current Derating Curve

TYPICAL PERFORMANCE CURVES (continued)

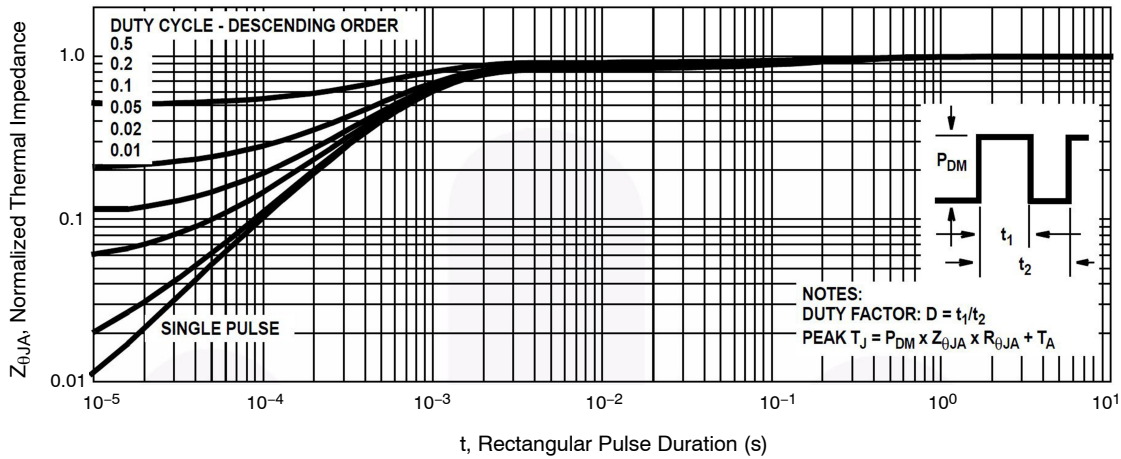

Figure 12. Normalized Maximum Transient Thermal Impedance

TEST CIRCUIT AND WAVEFORMS

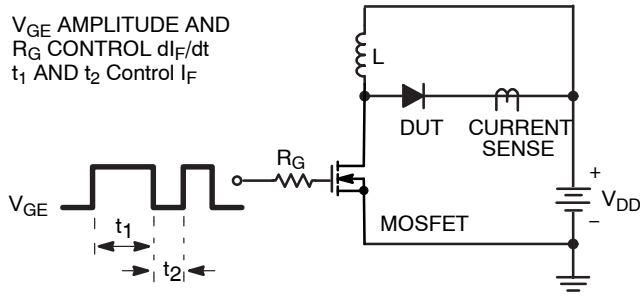

Figure 13. t_{rr} Test Circuit

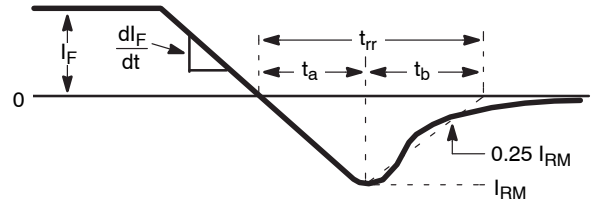

Figure 14. t_{rr} Waveforms and Definitions

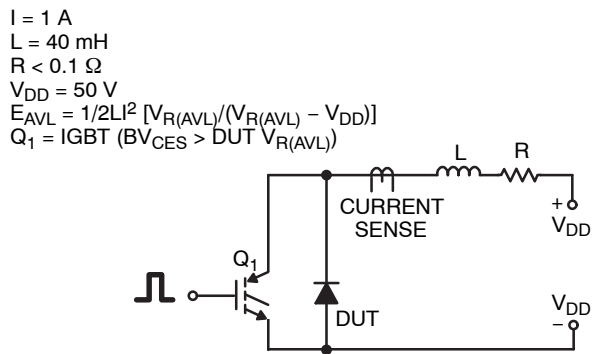

Figure 15. Avalanche Energy Test Circuit

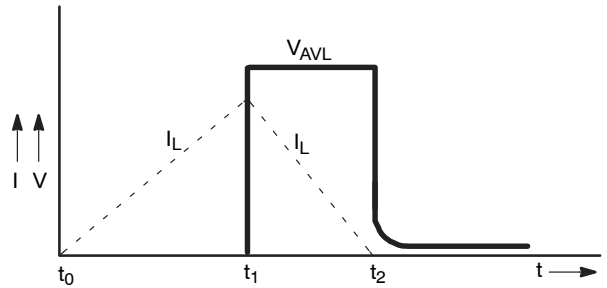
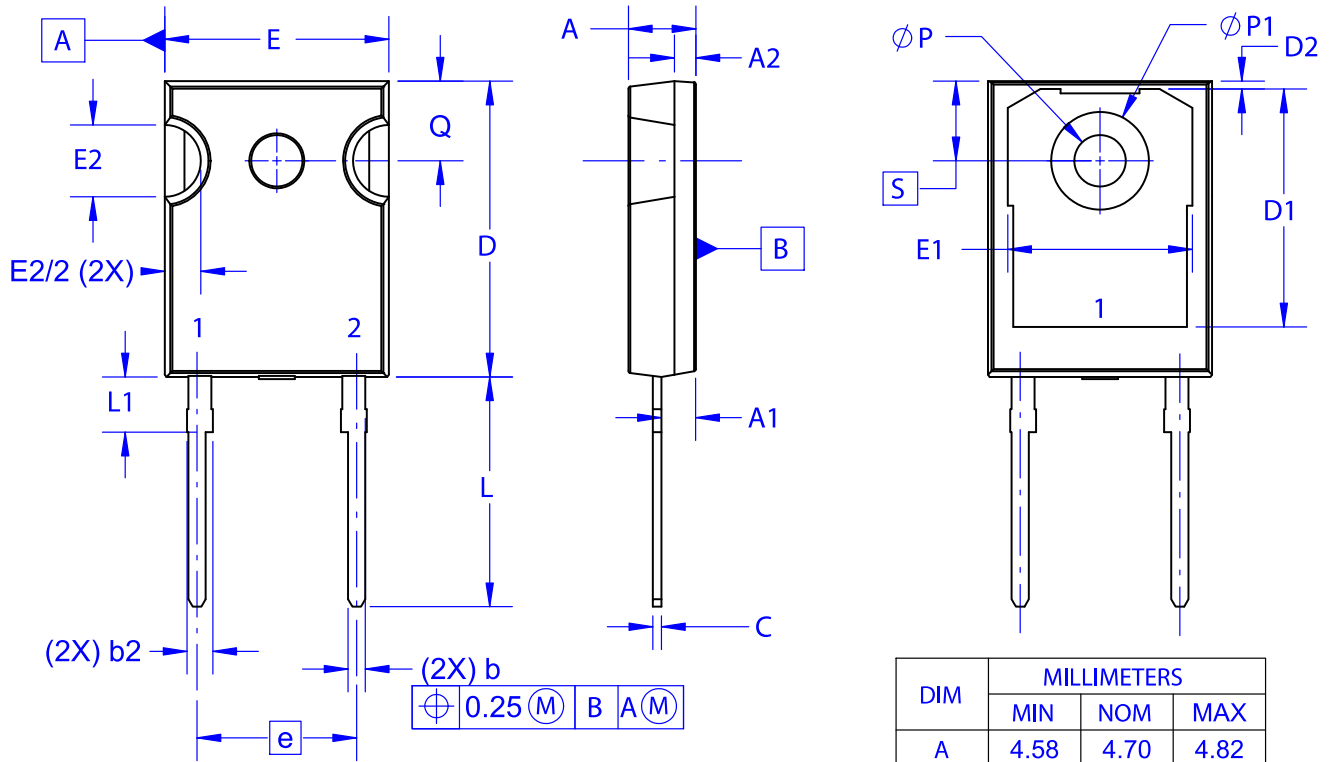

Figure 16. Avalanche Current and Voltage Waveforms

TO-247-2LD
CASE 340CL
ISSUE A

DATE 03 DEC 2019



NOTES: UNLESS OTHERWISE SPECIFIED.

- A. DIMENSIONS ARE EXCLUSIVE OF BURRS, MOLD FLASH, AND TIE BAR EXTRUSIONS.
- B. ALL DIMENSIONS ARE IN MILLIMETERS.
- C. DRAWING CONFORMS TO ASME Y14.5 - 2009.
- D. DIMENSION A1 TO BE MEASURED IN THE REGION DEFINED BY L1.
- E. LEAD FINISH IS UNCONTROLLED IN THE REGION DEFINED BY L1.

DIM	MILLIMETERS		
	MIN	NOM	MAX
A	4.58	4.70	4.82
A1	2.29	2.40	2.66
A2	1.30	1.50	1.70
b	1.17	1.26	1.35
b2	1.53	1.65	1.77
c	0.51	0.61	0.71
D	20.32	20.57	20.82
D1	16.37	16.57	16.77
D2	0.51	0.93	1.35
E	15.37	15.62	15.87
E1	12.81	~	~
E2	4.96	5.08	5.20
e	~	11.12	~
L	15.75	16.00	16.25
L1	3.69	3.81	3.93
ØP	3.51	3.58	3.65
ØP1	6.61	6.73	6.85
Q	5.34	5.46	5.58
S	5.34	5.46	5.58

GENERIC MARKING DIAGRAM*

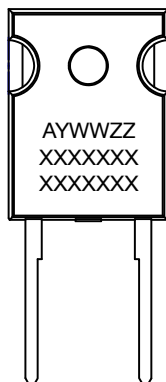

XXXX = Specific Device Code
 A = Assembly Location
 Y = Year
 WW = Work Week
 ZZ = Assembly Lot Code

*This information is generic. Please refer to device data sheet for actual part marking. Pb-Free indicator, "G" or microdot "•", may or may not be present. Some products may not follow the Generic Marking.

DOCUMENT NUMBER:	98AON13850G	Electronic versions are uncontrolled except when accessed directly from the Document Repository. Printed versions are uncontrolled except when stamped "CONTROLLED COPY" in red.
DESCRIPTION:	TO-247-2LD	PAGE 1 OF 1

onsemi and Onsemi are trademarks of Semiconductor Components Industries, LLC dba onsemi or its subsidiaries in the United States and/or other countries. onsemi reserves the right to make changes without further notice to any products herein. onsemi makes no warranty, representation or guarantee regarding the suitability of its products for any particular purpose, nor does onsemi assume any liability arising out of the application or use of any product or circuit, and specifically disclaims any and all liability, including without limitation special, consequential or incidental damages. onsemi does not convey any license under its patent rights nor the rights of others.

onsemi, **Onsemi**, and other names, marks, and brands are registered and/or common law trademarks of Semiconductor Components Industries, LLC dba "**onsemi**" or its affiliates and/or subsidiaries in the United States and/or other countries. **onsemi** owns the rights to a number of patents, trademarks, copyrights, trade secrets, and other intellectual property. A listing of **onsemi**'s product/patent coverage may be accessed at www.onsemi.com/site/pdf/Patent-Marking.pdf. **onsemi** reserves the right to make changes at any time to any products or information herein, without notice. The information herein is provided "as-is" and **onsemi** makes no warranty, representation or guarantee regarding the accuracy of the information, product features, availability, functionality, or suitability of its products for any particular purpose, nor does **onsemi** assume any liability arising out of the application or use of any product or circuit, and specifically disclaims any and all liability, including without limitation special, consequential or incidental damages. Buyer is responsible for its products and applications using **onsemi** products, including compliance with all laws, regulations and safety requirements or standards, regardless of any support or applications information provided by **onsemi**. "Typical" parameters which may be provided in **onsemi** data sheets and/or specifications can and do vary in different applications and actual performance may vary over time. All operating parameters, including "Typicals" must be validated for each customer application by customer's technical experts. **onsemi** does not convey any license under any of its intellectual property rights nor the rights of others. **onsemi** products are not designed, intended, or authorized for use as a critical component in life support systems or any FDA Class 3 medical devices or medical devices with a same or similar classification in a foreign jurisdiction or any devices intended for implantation in the human body. Should Buyer purchase or use **onsemi** products for any such unintended or unauthorized application, Buyer shall indemnify and hold **onsemi** and its officers, employees, subsidiaries, affiliates, and distributors harmless against all claims, costs, damages, and expenses, and reasonable attorney fees arising out of, directly or indirectly, any claim of personal injury or death associated with such unintended or unauthorized use, even if such claim alleges that **onsemi** was negligent regarding the design or manufacture of the part. **onsemi** is an Equal Opportunity/Affirmative Action Employer. This literature is subject to all applicable copyright laws and is not for resale in any manner.

ADDITIONAL INFORMATION

TECHNICAL PUBLICATIONS:

Technical Library: www.onsemi.com/design/resources/technical-documentation
onsemi Website: www.onsemi.com

ONLINE SUPPORT: www.onsemi.com/support

For additional information, please contact your local Sales Representative at www.onsemi.com/support/sales