

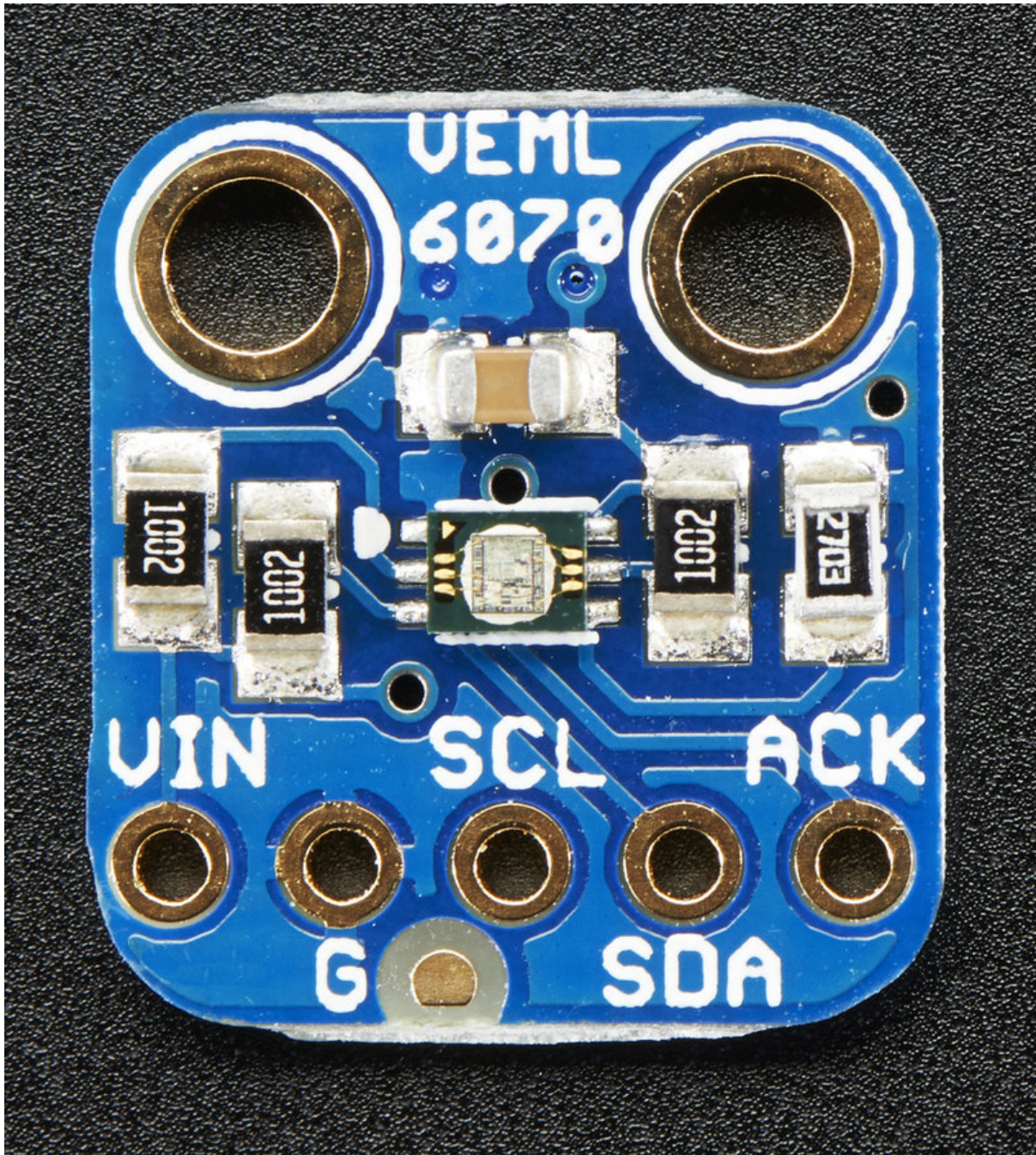

Adafruit VEML6070 UV Sensor Breakout

Created by lady ada



<https://learn.adafruit.com/adafruit-veml6070-uv-light-sensor-breakout>

Last updated on 2024-06-03 01:55:23 PM EDT

Table of Contents

Overview	3
Pinouts	4
<ul style="list-style-type: none">• Power Pins:• I2C Pins• Other	
Assembly	5
<ul style="list-style-type: none">• Prepare the header strip:• Add the breakout board:• And Solder!	
Arduino	7
<ul style="list-style-type: none">• Wiring for Arduino• Install Library• Load Demo	
Python & CircuitPython	11
<ul style="list-style-type: none">• CircuitPython Microcontroller Wiring• Python Computer Wiring• CircuitPython Installation of VEML6070 Library• Python Installation of VEML6070 Library• CircuitPython & Python Usage• Full Example Code	
Downloads	14
<ul style="list-style-type: none">• Schematic• Fabrication Print	

Overview

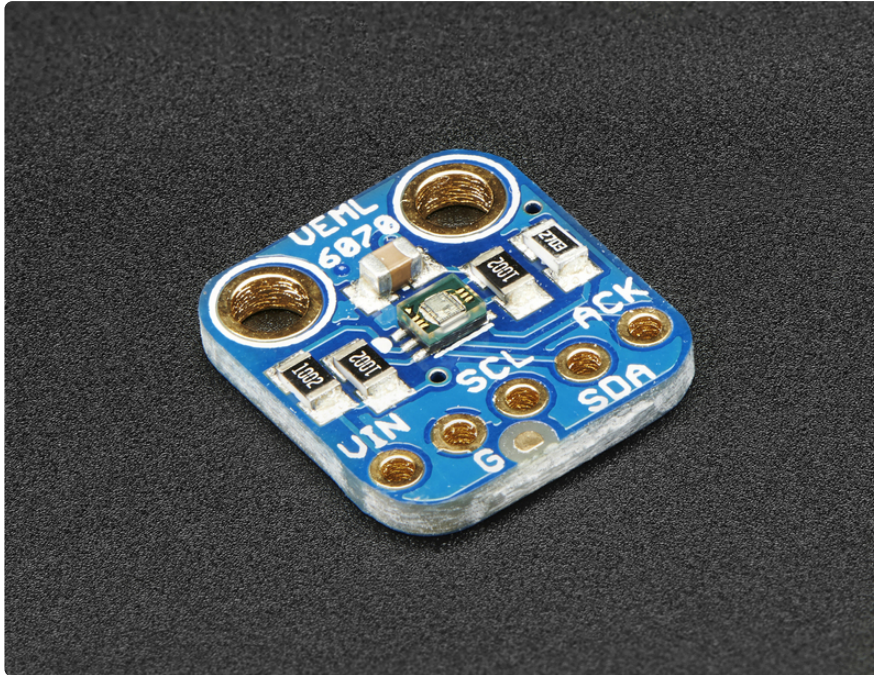

This little sensor is a great way to add UV light sensing to any microcontroller project. The VEML6070 from Vishay has a true UV A light sensor and an I2C-controlled ADC that will take readings and integrate them for you over ~60ms to 500ms.

Unlike the [Si1145](http://adafru.it/1777) (<http://adafru.it/1777>), this sensor will not give you UV Index readings. However, the Si1145 does UV Index approximations based on light level not true UV sensing. The VEML6070 in contrast does have a real light sensor in the UV spectrum. It's also got a much much simpler I2C interface so you can run it on the smallest microcontrollers with ease.

Unlike the [GUVA analog sensor](http://adafru.it/1918) (<http://adafru.it/1918>), the biasing and ADC is all internal so you don't need an ADC.

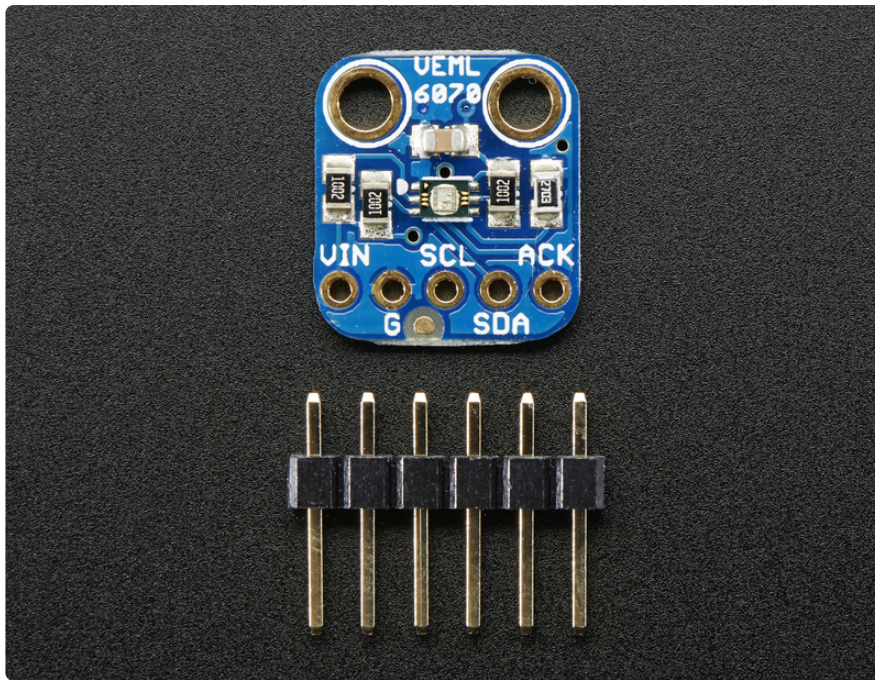

This UV sensor works great with 3 or 5V power or logic, its nice and compact, and its easy to use with any I2C-capable microcontroller.

Each order comes with one assembled PCB with a sensor, some handy pullup resistors, a 270K rset resistor and a small piece of header. Some light soldering is required to attach the header but its a fast task!

Pinouts

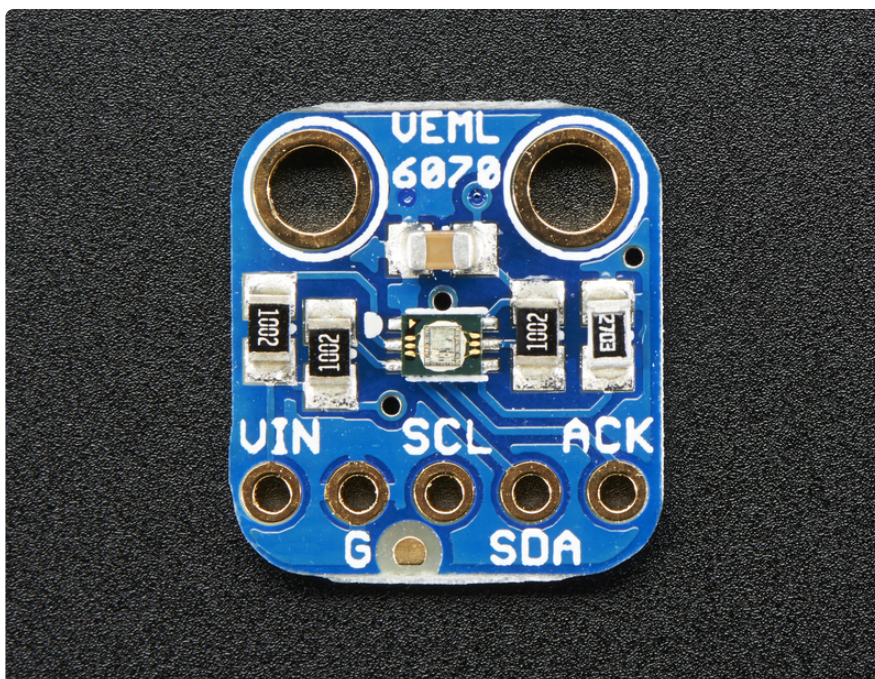

Power Pins:

- **Vin** - this is the power pin. The sensor chip uses 3 to 5 VDC, so you can use it with just about any microcontroller. To power the board, give it the same power as the logic level of your microcontroller - e.g. for a 5V micro like Arduino, use 5V
- **GND** - common ground for power and logic

I2C Pins

- **SCL** - I2C clock pin, connect to your microcontrollers I2C clock line. This pin can be used with 3V or 5V logic, and there's a 10K pullup on this pin.
- **SDA** - I2C data pin, connect to your microcontrollers I2C data line. This pin can be used with 3V or 5V logic, and there's a 10K pullup on this pin.

Other

- **ACK Pin** - This is the interrupt/alert output. You can set up the sensor to warn you on overly high or low UV signal. Logic level is the same as whatever you set Vin

Assembly

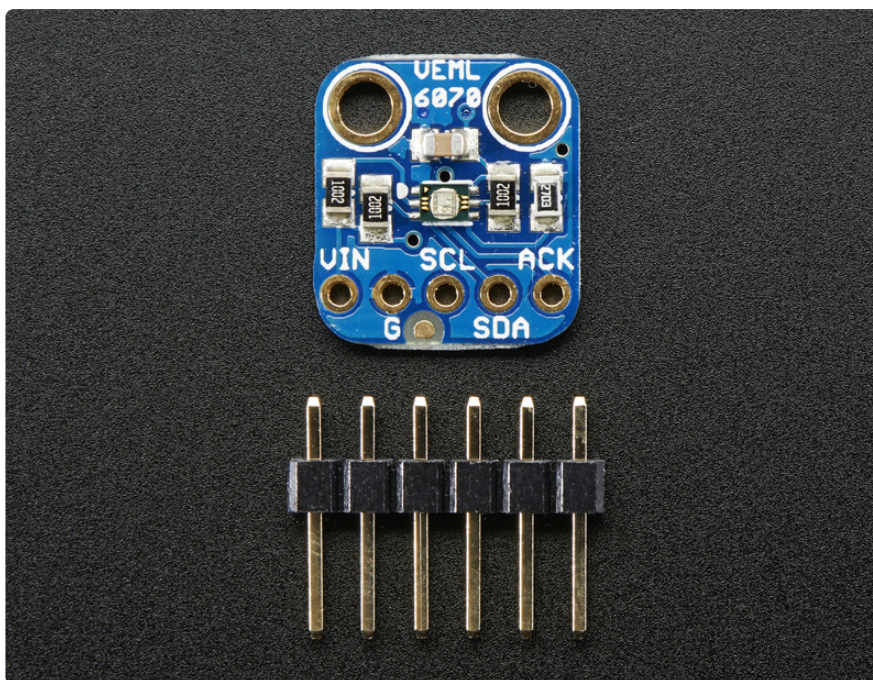

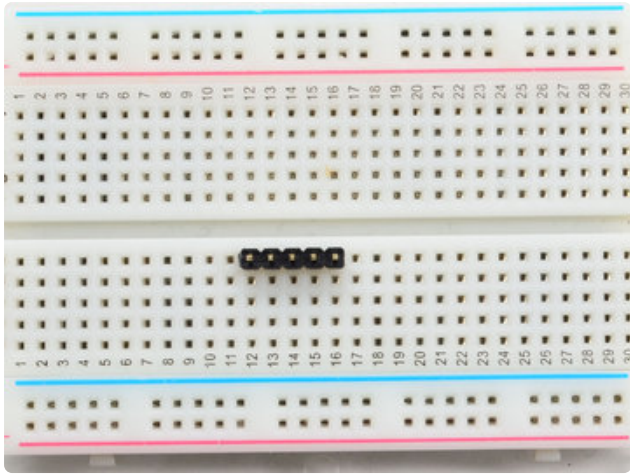

Prepare the header strip:

Cut the strip to length if necessary. It will be easier to solder if you insert it into a breadboard - **long pins down**

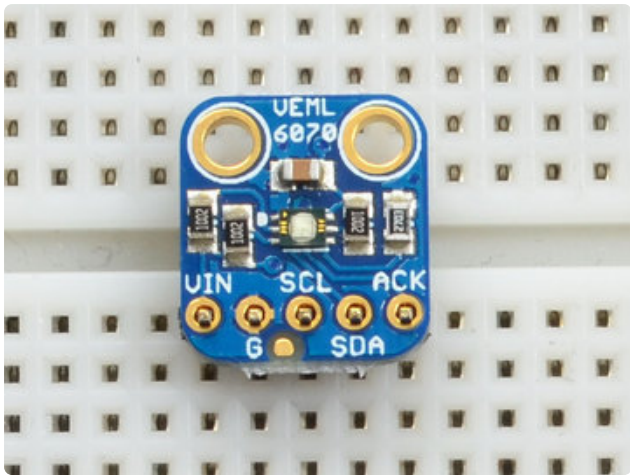

Add the breakout board:

Place the breakout board over the pins so that the short pins poke through the breakout pads

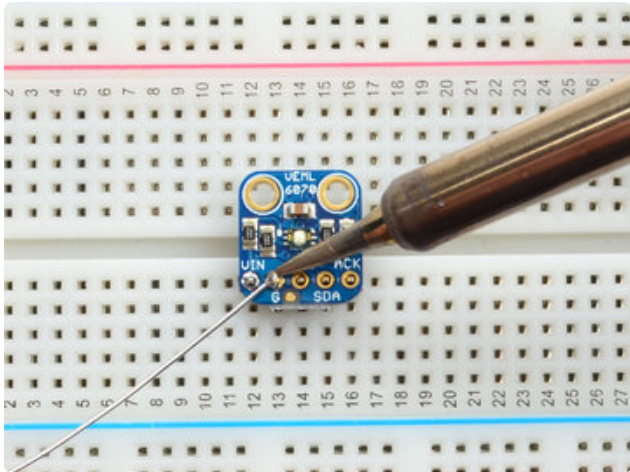

And Solder!

Be sure to solder all pins for reliable electrical contact.

Solder the longer power/data strip first

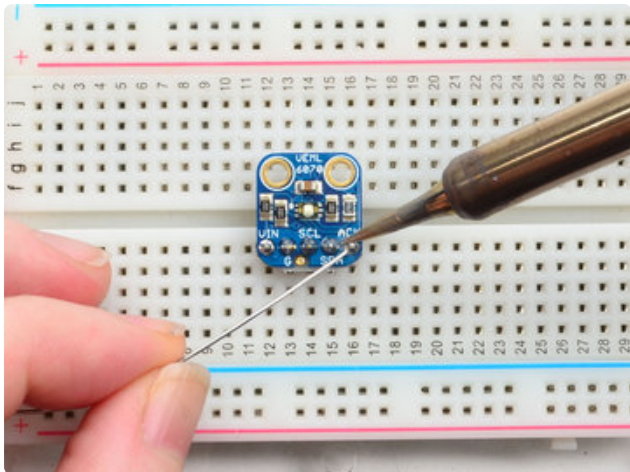

(For tips on soldering, be sure to check out our [Guide to Excellent Soldering \(https://adafruit.it/aTk\)](https://adafruit.it/aTk)).

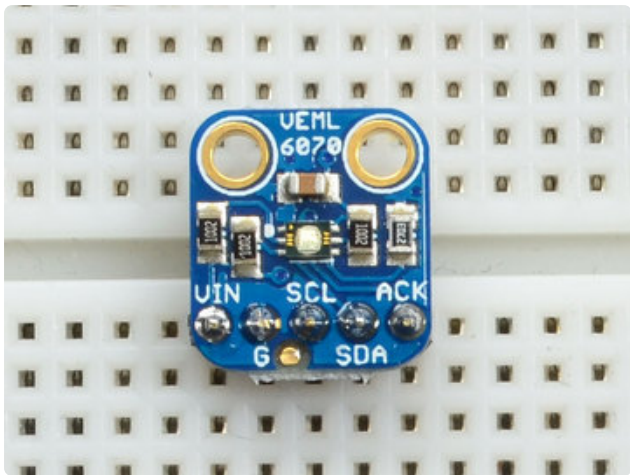

You're done! Check your solder joints visually and continue onto the next steps

Arduino

Wiring for Arduino

You can easily wire this breakout to any microcontroller, we'll be using an Arduino. For another kind of microcontroller, just make sure it has I2C capability, then port the code - its pretty simple stuff!

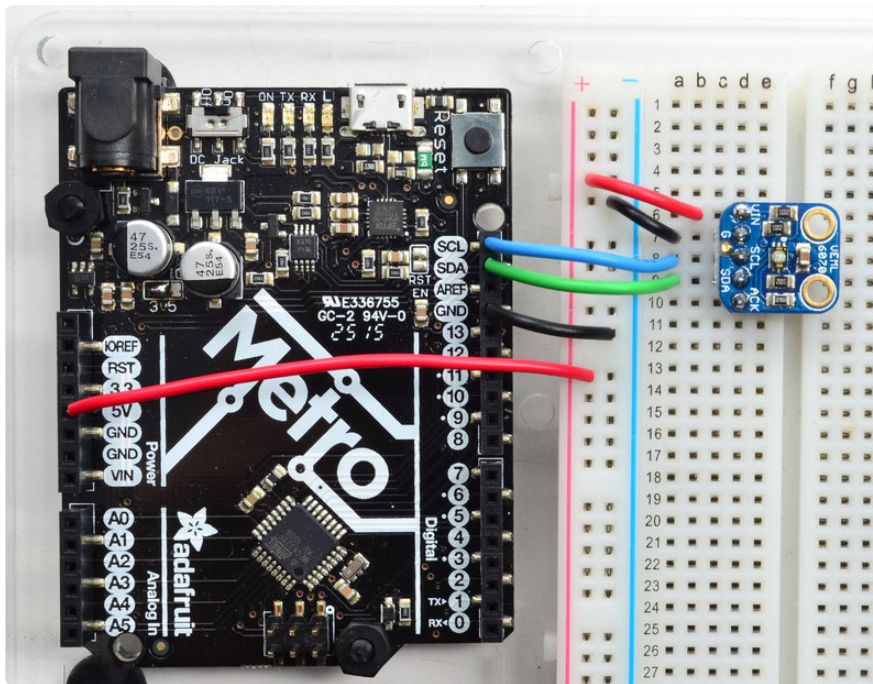

- Connect **Vin** to the power supply, 3-5V is fine. Use the same voltage that the microcontroller logic is based off of. For most Arduinos, that is 5V
- Connect **GND** to common power/data ground
- Connect the **SCL** pin to the I2C clock **SCL** pin on your Arduino. On an UNO & '328 based Arduino, this is also known as **A5**, on a Mega it is also known as **digital 21** and on a Leonardo/Micro, **digital 3**
- Connect the **SDA** pin to the I2C data **SDA** pin on your Arduino. On an UNO & '328 based Arduino, this is also known as **A4**, on a Mega it is also known as **digital 20** and on a Leonardo/Micro, **digital 2**

Install Library

To begin reading sensor data, you will need to download the **Adafruit VEML6070** library from the Arduino library manager.

Open up the Arduino library manager:

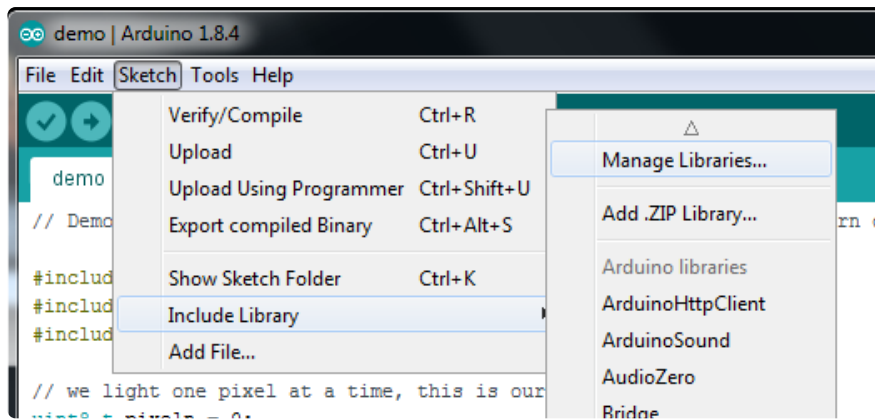

Search for the **Adafruit VEML6070** library and install it

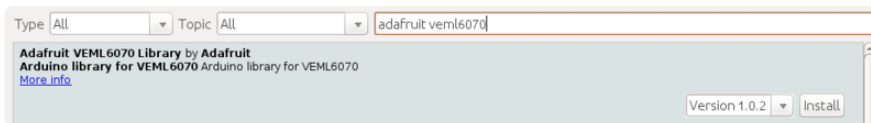

We also have a great tutorial on Arduino library installation at:

<http://learn.adafruit.com/adafruit-all-about-arduino-libraries-install-use> (<https://adafru.it/aYM>)

Load Demo

Open up **File->Examples->Adafruit_VEML6070->vemltest** and upload to your Arduino wired up to the sensor

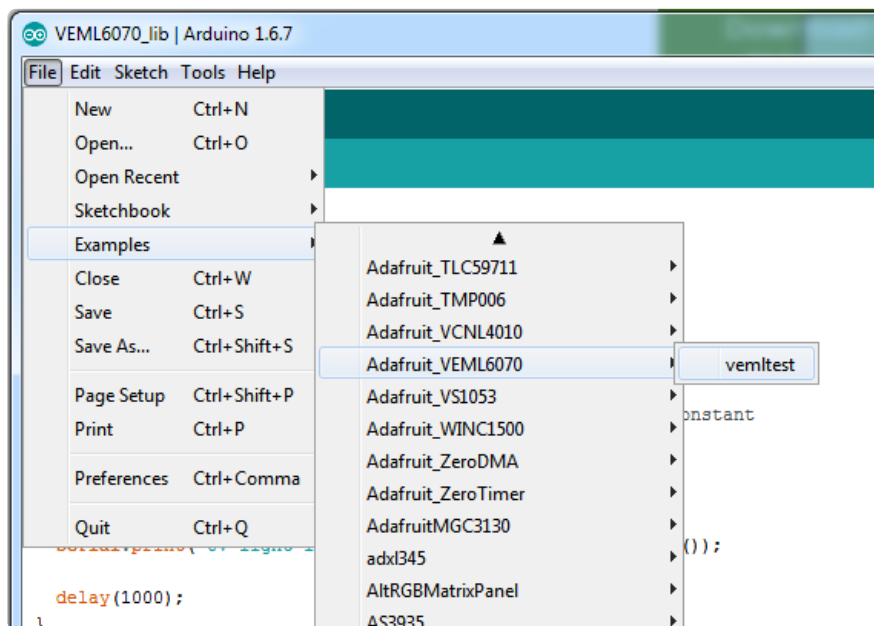

Upload to the Arduino and open up the serial console at **9600 baud** to see the UV data output. Note that this is not UV index, its just UV light intensity!

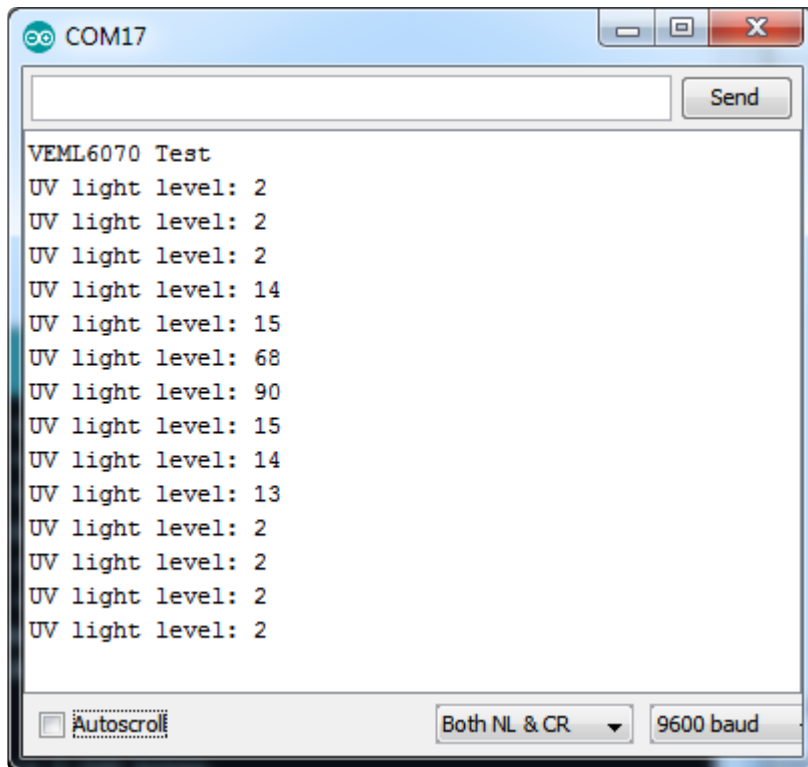

If you're integrating this sensor into your project, its fairly easy to do.

Start by instantiating the sensor with:

```
Adafruit_VEML6070 uv = Adafruit_VEML6070();
```

Note that since this a pure I2C sensor, there's not pin configuration for instantiation

Next, you will call **begin()** in your setup procedure. There are 4 different 'integration' times used to calculate the intensity. The longer the integration time, the more light is collected. Use shorter integration times if you want to get measurements quickly with less precision. Longer times will give you more precision but of course, take longer!

- **VEML6070_HALF_T** ~62.5ms
- **VEML6070_1_T** ~125ms
- **VEML6070_2_T** ~250ms
- **VEML6070_4_T** ~500ms

Pass the integration time constant into **begin** like:

```
uv.begin(VEML6070_1_T)
```

Then you can call **readUV** which will give you a 16-bit value relating to how much UV was detected. Again, this is not an UV index value, its unitless. You may need to calibrate the value against a known value depending on your usage!

Python & CircuitPython

It's easy to use the VEML6070 sensor with Python or CircuitPython and the [Adafruit CircuitPython VEML6070 \(https://adafru.it/C6-\)](https://adafru.it/C6-) module. This module allows you to easily write Python code that reads the UV index from the sensor.

You can use this sensor with any CircuitPython microcontroller board or with a computer that has GPIO and Python [thanks to Adafruit_Blinka, our CircuitPython-for-Python compatibility library \(https://adafru.it/BSN\)](https://adafru.it/BSN).

CircuitPython Microcontroller Wiring

First wire up a VEML6070 to your board exactly as shown in the previous pages for Arduino. Here's an example of wiring a Feather M0 to the sensor with I2C:

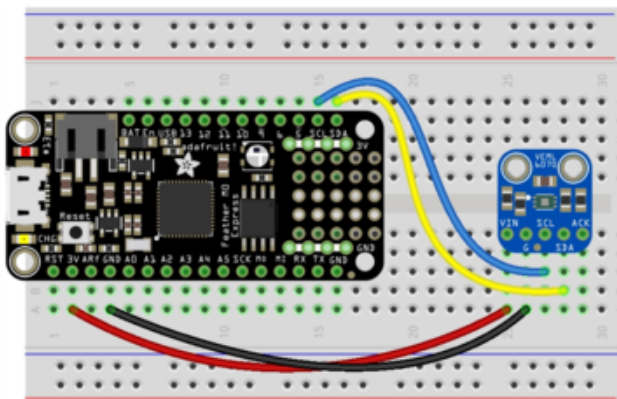

Board 3V to sensor VIN
Board GND to sensor G
Board SCL to sensor SCL
Board SDA to sensor SDA

Python Computer Wiring

Since there's dozens of Linux computers/boards you can use we will show wiring for Raspberry Pi. For other platforms, [please visit the guide for CircuitPython on Linux to see whether your platform is supported \(https://adafru.it/BSN\)](https://adafru.it/BSN).

Here's the Raspberry Pi wired with I2C:

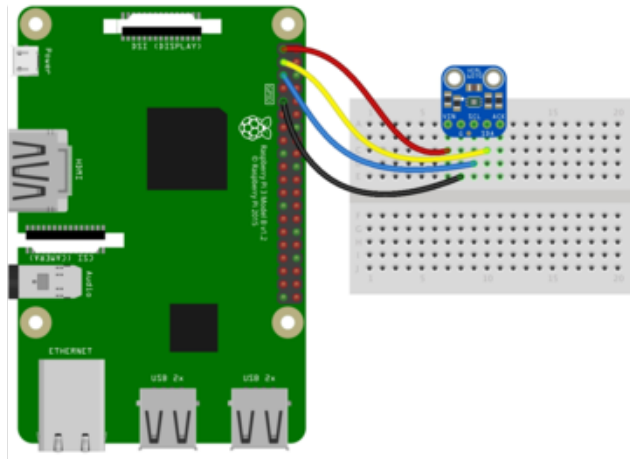

Pi 3V3 to sensor VIN
Pi GND to sensor GND
Pi SCL to sensor SCK
Pi SDA to sensor SDA

CircuitPython Installation of VEML6070 Library

You'll need to install the [Adafruit CircuitPython VEML6070 \(https://adafru.it/C6-\)](https://adafru.it/C6-) library on your CircuitPython board.

First make sure you are running the [latest version of Adafruit CircuitPython \(https://adafru.it/Amd\)](https://adafru.it/Amd) for your board.

Next you'll need to install the necessary libraries to use the hardware--carefully follow the steps to find and install these libraries from [Adafruit's CircuitPython library bundle \(https://adafru.it/uap\)](https://adafru.it/uap). Our Welcome to CircuitPython guide has [a great page on how to install the library bundle \(https://adafru.it/ABU\)](https://adafru.it/ABU).

For non-express boards like the Trinket M0 or Gemma M0, you'll need to manually install the necessary libraries from the bundle:

- `adafruit_veml6070.mpy`
- `adafruit_bus_device`

Before continuing make sure your board's lib folder or root filesystem has the `adafruit_veml6070.mpy`, and `adafruit_bus_device` files and folders copied over.

Next [connect to the board's serial REPL \(https://adafru.it/Awz\)](https://adafru.it/Awz) so you are at the CircuitPython `>>>` prompt.

Python Installation of VEML6070 Library

You'll need to install the Adafruit_Blinka library that provides the CircuitPython support in Python. This may also require enabling I2C on your platform and verifying you are running Python 3. [Since each platform is a little different, and Linux changes often, please visit the CircuitPython on Linux guide to get your computer ready \(https://adafru.it/BSN\)](https://adafru.it/BSN)!

Once that's done, from your command line run the following command:

- `sudo pip3 install adafruit-circuitpython-veml6070`

If your default Python is version 3 you may need to run 'pip' instead. Just make sure you aren't trying to use CircuitPython on Python 2.x, it isn't supported!

CircuitPython & Python Usage

To demonstrate the usage of the sensor we'll initialize it and read the UV index from the board's Python REPL.

First, run the following code to import the necessary modules:

```
import time
import board
import adafruit_veml6070
```

Now you're ready to setup the sensor and read the values using these properties:

- **read** - reads and returns the value of the UV intensity
- **get_index** - the UV Risk Level based on the captured UV reading

For example, run the following to setup the I2C object, get the raw UV reading, use that reading to determine the risk level:

```
with board.I2C() as i2c:
    uv = adafruit_veml6070.VEML6070(i2c)
    uv_raw = uv.read
    risk_level = uv.get_index(uv_raw)
```

Then you can print the results:

```
print('Reading: {0} | Risk Level: {1}'.format(uv_raw, risk_level))
```

```
>>> print('Reading: {0} | Risk Level: {1}'.format(uv_raw, risk_level))
Reading: 4 | Risk Level: LOW
>>> █
```

That's all there is to using VEML6070 with Python and CircuitPython!

Full Example Code

```
# SPDX-FileCopyrightText: 2021 ladyada for Adafruit Industries
# SPDX-License-Identifier: MIT

# VEML6070 Driver Example Code

import time
import board
import adafruit_veml6070

i2c = board.I2C() # uses board.SCL and board.SDA
# i2c = board.STEMMA_I2C() # For using the built-in STEMMMA QT connector on a
microcontroller

uv = adafruit_veml6070.VEML6070(i2c)
# Alternative constructors with parameters
# uv = adafruit_veml6070.VEML6070(i2c, 'VEML6070_1_T')
# uv = adafruit_veml6070.VEML6070(i2c, 'VEML6070_HALF_T', True)

# take 10 readings
for j in range(10):
    uv_raw = uv.uv_raw
    risk_level = uv.get_index(uv_raw)
    print("Reading: {0} | Risk Level: {1}".format(uv_raw, risk_level))
    time.sleep(1)
```

Downloads

- PCB files at <https://github.com/adafruit/Adafruit-VEML6070-PCB> (<https://adafru.it/nCi>)
- Library files at https://github.com/adafruit/Adafruit_VEML6070 (<https://adafru.it/nCd>)
- [Fritzing object available in the Adafruit Fritzing Library](https://adafru.it/aP3) (<https://adafru.it/aP3>)
- [VEML6070 Datasheet](https://adafru.it/rsE) (<https://adafru.it/rsE>)

Schematic

Click to embiggen

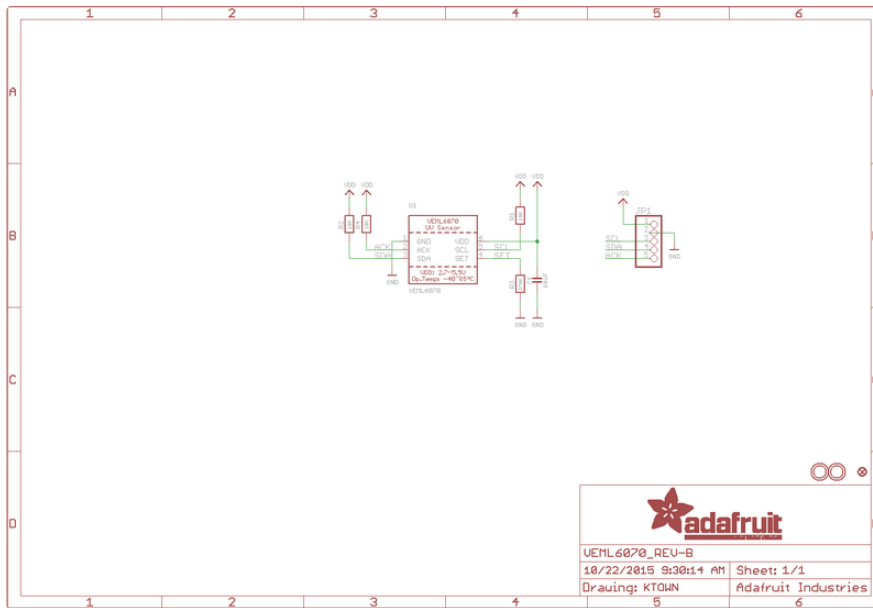

Fabrication Print

Dimensions in inches

