

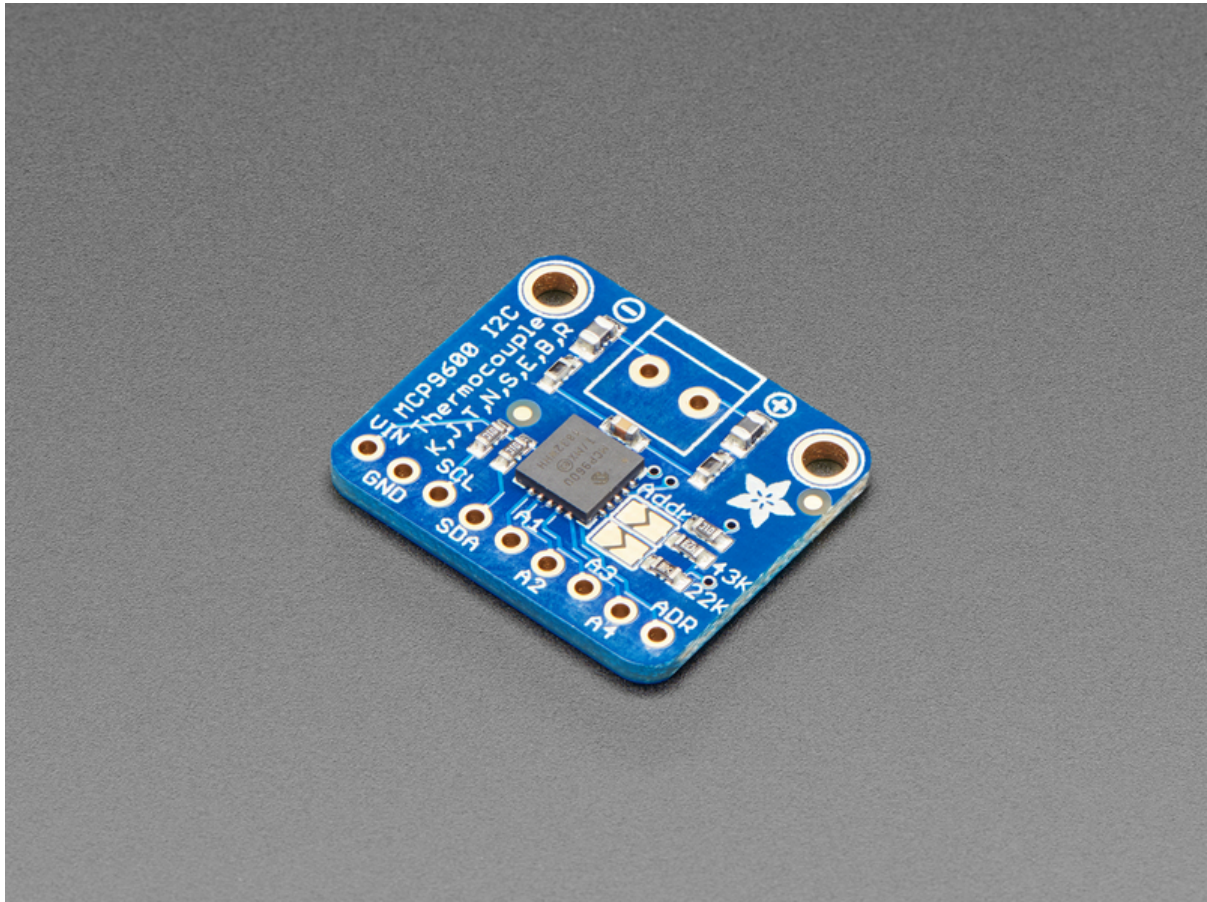

Adafruit MCP9600 I2C Thermocouple Amplifier

Created by Kattni Rembor



<https://learn.adafruit.com/adafruit-mcp9600-i2c-thermocouple-amplifier>

Last updated on 2024-06-03 02:47:37 PM EDT

Table of Contents

Overview	3
Pinouts	5
<ul style="list-style-type: none">• Power Pins• I2C Logic Pins• Alert Pins• Address Pin• Changing the I2C Address	
Arduino	8
<ul style="list-style-type: none">• Wiring• Installation• Load Example• Example Code	
Arduino Docs	11
Python & CircuitPython	11
<ul style="list-style-type: none">• CircuitPython Microcontroller Wiring• Python Computer Wiring• CircuitPython Installation of MCP9600 Library• Python Installation of MCP9600 Library• CircuitPython and Python Usage• Full Example Code• Alerts and More	
Python Docs	15
Downloads	15
<ul style="list-style-type: none">• Files• Schematic• Fab Print	

Overview

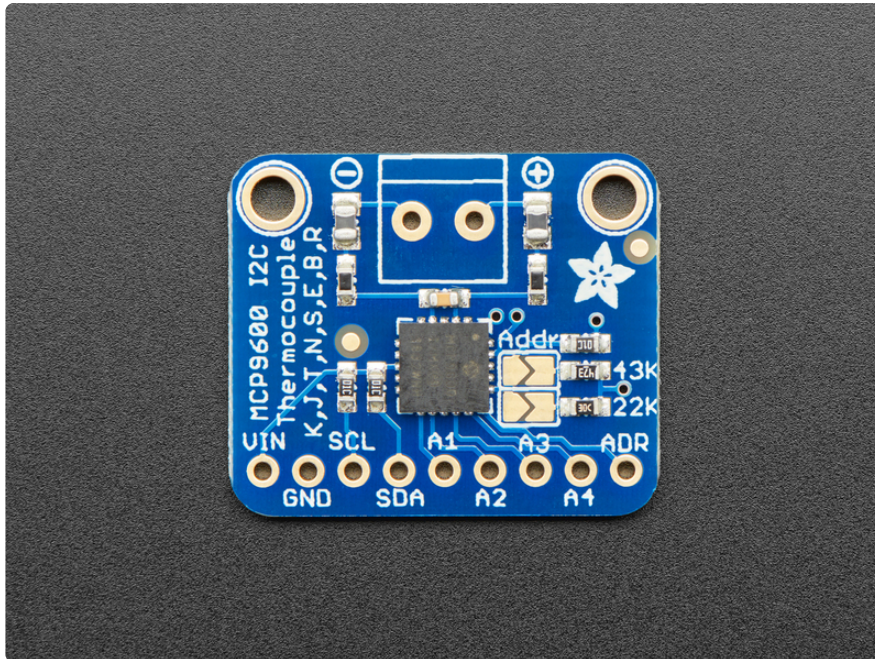

Thermocouples are very sensitive, requiring a good amplifier with a cold-compensation reference. The **Adafruit MCP9600** does all that for you, and can be easily interfaced with any microcontroller or single-board-computer with I2C. Inside, the chip handles all the analog stuff for you, and can interface with just about any thermocouple type: K, J, T, N, S, E, B and R type are all supported! You can also set various alerts for over/under temperature, and read the thermocouple (hot) temperature and the chip (cold) temperature. All this over common I2C.

This breakout board has the chip itself, a 3.3V regulator and level shifting circuitry, all assembled and tested. Works great with 3.3V or 5V logic. Comes with a 2 pin terminal block (for connecting to the thermocouple) and pin header (to plug into any breadboard or perfboard).

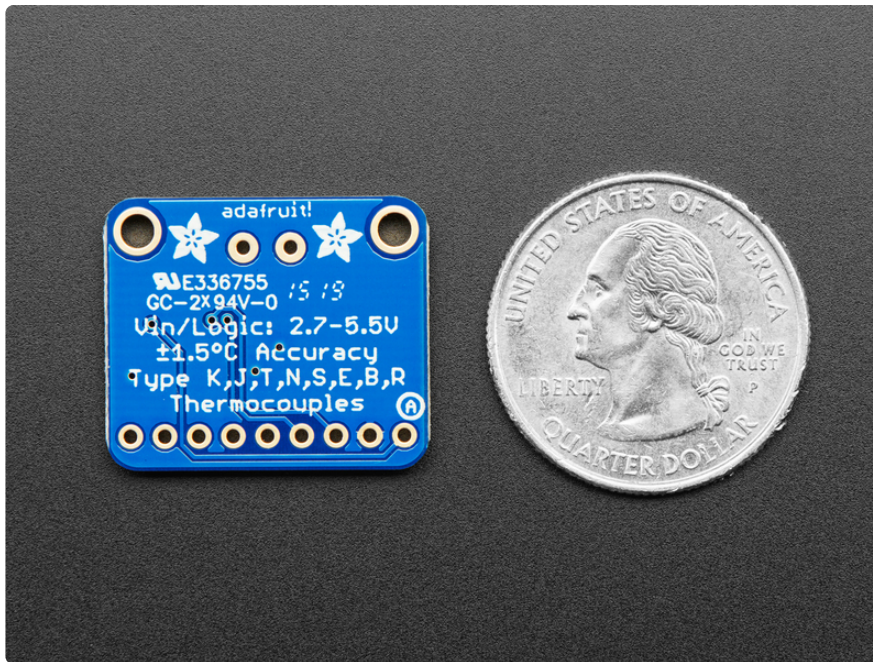

The Adafruit MCP9600 features:

- Works with any K, J, T, N, S, E, B and R type thermocouple
- Datasheet rated for:
 - K Type: -200°C to +1372°C
 - J Type: -150°C to +1200°C
 - T Type: -200°C to +400°C
 - N Type: -150°C to +1300°C
 - E Type: -200°C to +1000°C
 - S Type: +250°C to +1664°C
 - B Type: +1000°C to +1800°C
 - R Type: +250°C to +1664°C
- Resolution of ± 0.0625 °C - note that K thermocouples have about ± 2 °C to ± 6 °C accuracy
- Internal temperature reading
- 3.3 to 5v power supply and logic level compliant
- I2C data connection

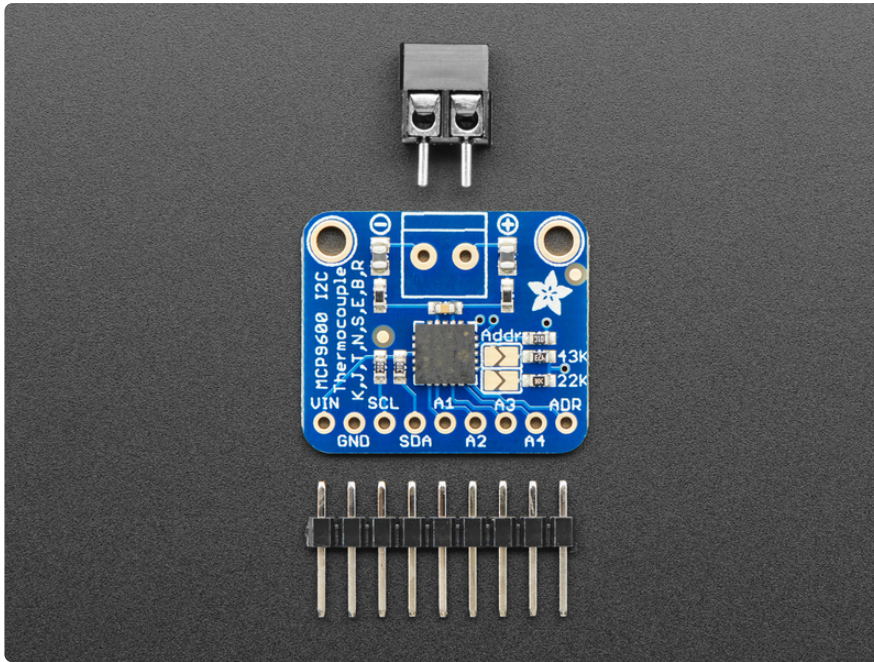

Pinouts

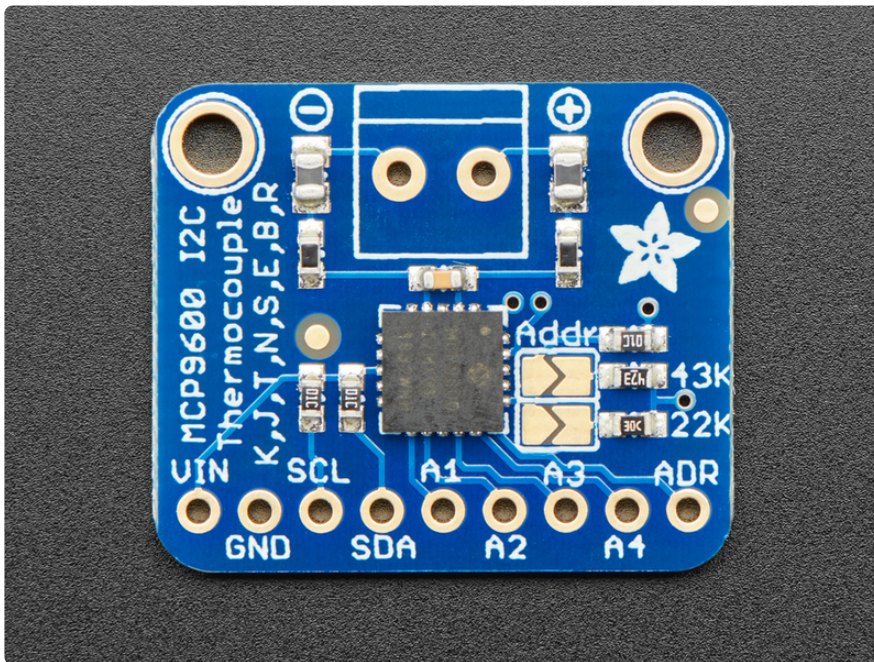

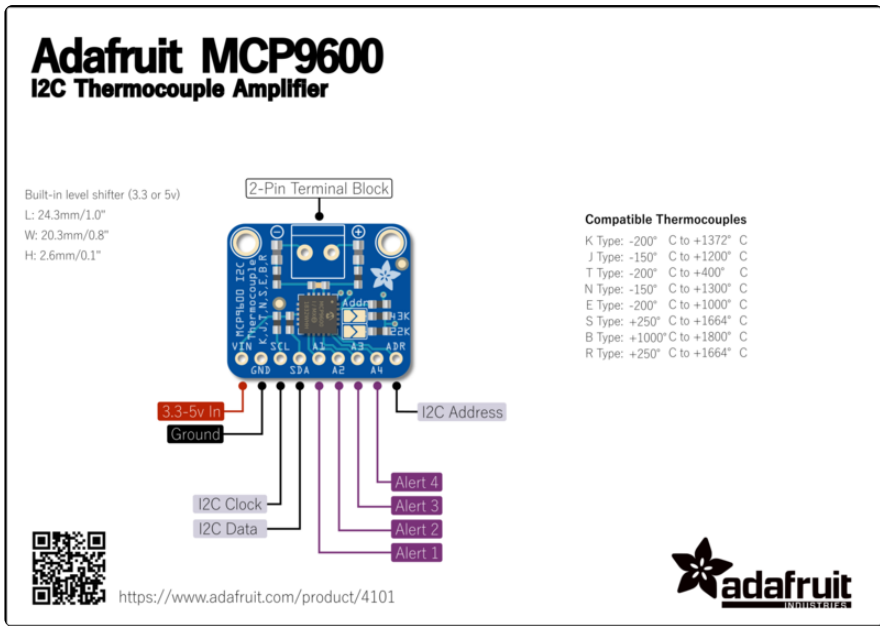

Power Pins

- **Vin** - this is the power pin. This chip can handle 2.7V to 5V. To power the board, give it the same power as the logic level of your microcontroller - e.g. for a 5V micro like Arduino, use 5V
- **GND** - common ground for power and logic

I2C Logic Pins

Default I2C address is **0x67**.

- **SCL** - this is the I2C clock pin, connect to your microcontroller's I2C clock line.
- **SDA** - this is the I2C data pin, connect to your microcontroller's I2C data line.

Alert Pins

- **A1 - A4** - Alert 1 - Alert 4 output pins

Address Pin

- **ADDR** - Allows for setting I2C address.

Changing the I2C Address

By default, the ADDR pin is tied to Vin. This sets the default I2C address to 0x67. To change the I2C address, you can use the provided jumpers, or tie the ADDR pin directly to GND. This breakout supports a total of five I2C addresses, meaning you can connect up to five MCP9600 breakouts on the same I2C bus.

Use the following table to determine what to apply to the ADDR pin to get the desired address. The jumpers are numbered in the image. **J1** applies to jumper 1, and **J2** applies to jumper 2. An - in the table means no action needed, and an **X** in the table means to solder closed a jumper. The final address requires tying the ADDR pin to the GND pin, and in that case, all other changes are ignored.

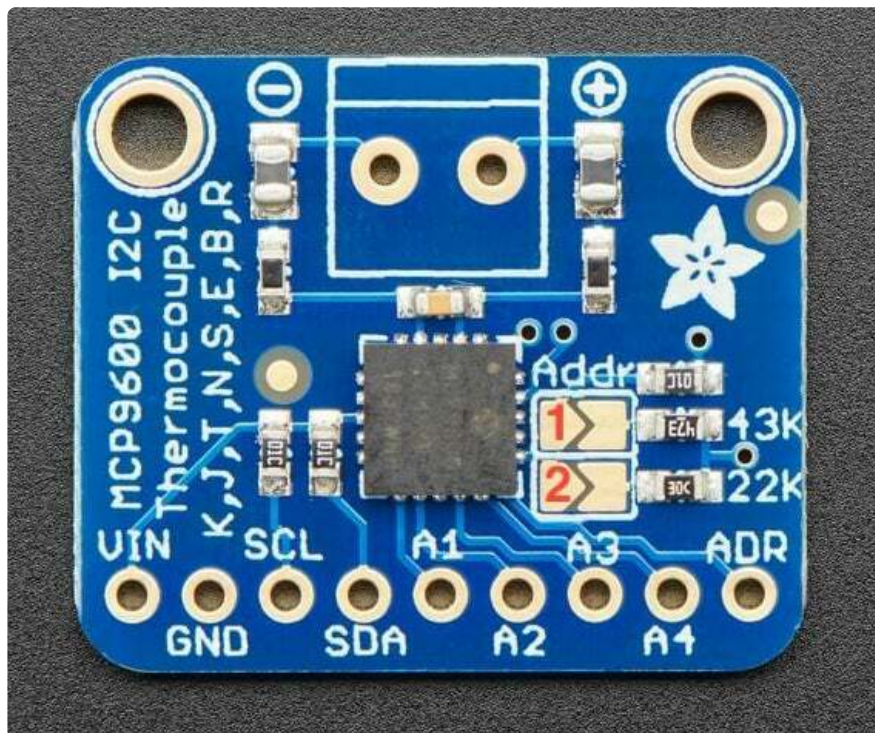

Address	J1	J2
0x67	-	-
0x66	X	-
0x65	-	X
0x64	X	X
0x60	(ADDR to GND)	

Arduino

Wiring

Connecting the MCP9600 to your Feather or Metro / Arduino is easy:

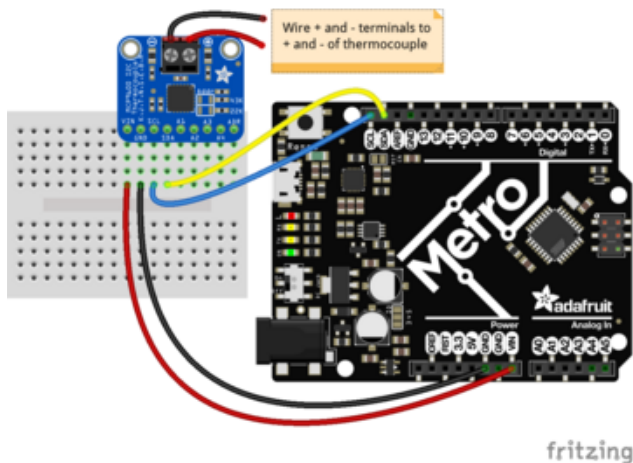

If you are running a Feather (3.3V),

connect **Feather 3V** to **board VIN**

If you are running a 5V Arduino (Uno, etc.),

connect **Arduino 5V** to **board VIN**

Connect **Feather or Arduino GND** to **board GND**

Connect **Feather or Arduino SCL** to **board SCL**

Connect **Feather or Arduino SDA** to **board SDA**

Connect **thermocouple +** to **board screw terminal +**

Connect **thermocouple -** to **board screw terminal -**

The final results should resemble the illustration above, showing an Adafruit Metro development board.

The MCP9600 will return a temperature for the hot junction even if there is no thermocouple connected. There will not be an error!

Installation

You can install the **Adafruit MCP9600 Library** for Arduino using the Library Manager in the Arduino IDE:

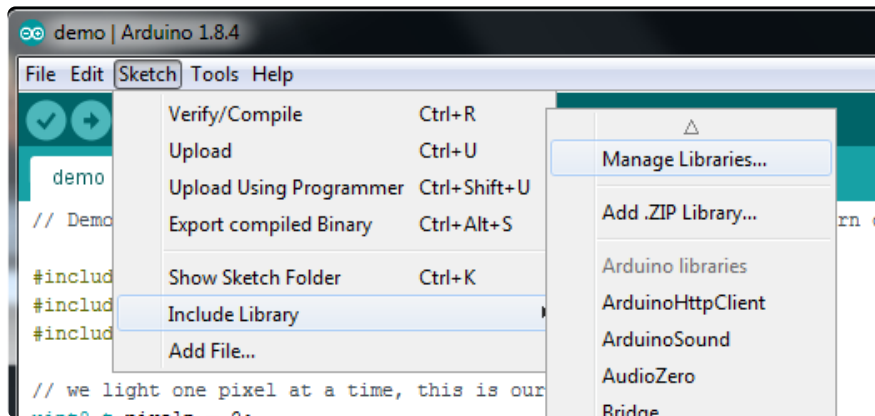

Click the **Manage Libraries ...** menu item, search for **Adafruit MCP9600**, and select the **Adafruit MCP9600** library:

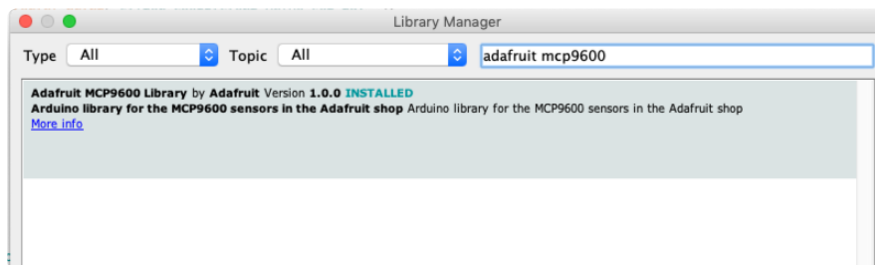

Also get the **Adafruit BusIO** library

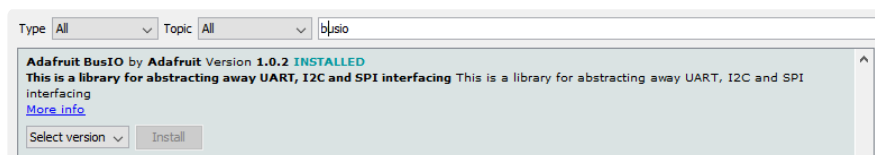

Load Example

Open up **File -> Examples -> Adafruit MCP9600 -> mcp9600_test** and upload to your Arduino wired up to the sensor.

Upload the sketch to your board and open up the Serial Monitor (**Tools->Serial Monitor**). You should see the the values for hot junction, cold junction and ADC.

Example Code

The following example code is part of the standard library, but illustrates how you can retrieve sensor data from the MCP9600 for the hot junction, cold junction and ADC values:

```
#include <Wire.h>
#include <Adafruit_I2CDevice.h>
#include <Adafruit_I2CRegister.h>
#include "Adafruit_MCP9600.h"

#define I2C_ADDRESS (0x67)

Adafruit_MCP9600 mcp;

void setup()
{
  Serial.begin(115200);
  while (!Serial) {
    delay(10);
  }
  Serial.println("MCP9600 HW test");

  /* Initialise the driver with I2C_ADDRESS and the default I2C bus. */
  if (!mcp.begin(I2C_ADDRESS)) {
    Serial.println("Sensor not found. Check wiring!");
    while (1);
  }

  Serial.println("Found MCP9600!");

  mcp.setADCResolution(MCP9600_ADCRESOLUTION_18);
  Serial.print("ADC resolution set to ");
  switch (mcp.getADCResolution()) {
    case MCP9600_ADCRESOLUTION_18: Serial.print("18"); break;
    case MCP9600_ADCRESOLUTION_16: Serial.print("16"); break;
    case MCP9600_ADCRESOLUTION_14: Serial.print("14"); break;
    case MCP9600_ADCRESOLUTION_12: Serial.print("12"); break;
  }
  Serial.println(" bits");

  mcp.setThermocoupleType(MCP9600_TYPE_K);
  Serial.print("Thermocouple type set to ");
  switch (mcp.getThermocoupleType()) {
    case MCP9600_TYPE_K: Serial.print("K"); break;
    case MCP9600_TYPE_J: Serial.print("J"); break;
    case MCP9600_TYPE_T: Serial.print("T"); break;
    case MCP9600_TYPE_N: Serial.print("N"); break;
    case MCP9600_TYPE_S: Serial.print("S"); break;
    case MCP9600_TYPE_E: Serial.print("E"); break;
    case MCP9600_TYPE_B: Serial.print("B"); break;
    case MCP9600_TYPE_R: Serial.print("R"); break;
  }
  Serial.println(" type");

  mcp.setFilterCoefficient(3);
  Serial.print("Filter coefficient value set to: ");
  Serial.println(mcp.getFilterCoefficient());

  mcp.setAlertTemperature(1, 30);
  Serial.print("Alert #1 temperature set to ");
  Serial.println(mcp.getAlertTemperature(1));
  mcp.configureAlert(1, true, true); // alert 1 enabled, rising temp
```

```

mcp.enable(true);

Serial.println(F("-----"));
}

void loop()
{
  Serial.print("Hot Junction: "); Serial.println(mcp.readThermocouple());
  Serial.print("Cold Junction: "); Serial.println(mcp.readAmbient());
  Serial.print("ADC: "); Serial.print(mcp.readADC() * 2); Serial.println(" uV");
  delay(1000);
}

```

You should get something resembling the following output when you open the Serial Monitor at 115200 baud:

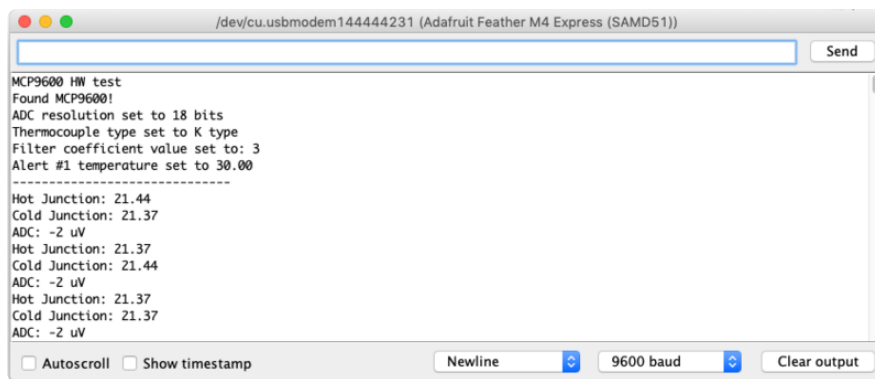

Note: The image above shows 9600 baud in the serial monitor. It should be 115200 to match the code!

Arduino Docs

[Arduino Docs \(https://adafru.it/EZR\)](https://adafru.it/EZR)

Python & CircuitPython

It's easy to use the MCP9600 thermocouple amplifier with CircuitPython or Python, and the [Adafruit CircuitPython MCP9600 \(https://adafru.it/GiD\)](https://adafru.it/GiD) module. This module allows you to easily write Python code that reads the temperature from the sensor.

You can use this sensor with any CircuitPython microcontroller board or with a computer that has GPIO and Python [thanks to Adafruit_Blinka, our CircuitPython-for-Python compatibility library \(https://adafru.it/BSN\)](https://adafru.it/BSN).

CircuitPython Microcontroller Wiring

First wire up a MCP9600 to your board exactly as shown on the previous pages for Arduino. Here's an example of wiring a Feather M0 to the sensor with I2C:

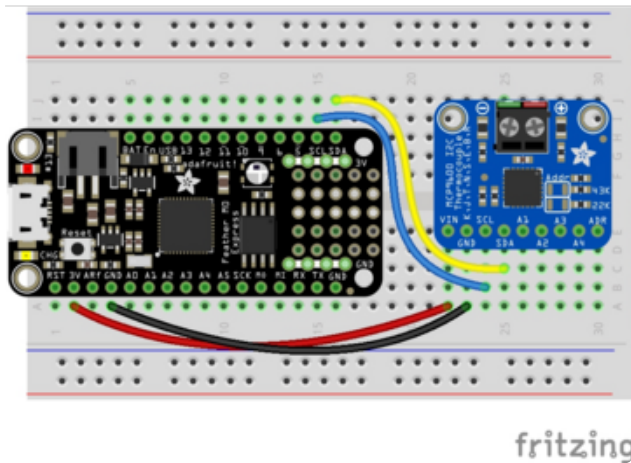

Board 3V to sensor VIN
Board GND to sensor GND
Board SCL to sensor SCL
Board SDA to sensor SDA

Python Computer Wiring

Since there's dozens of Linux computers/boards you can use we will show wiring for Raspberry Pi. For other platforms, [please visit the guide for CircuitPython on Linux to see whether your platform is supported \(https://adafru.it/BSN\)](https://adafru.it/BSN).

Here's the Raspberry Pi wired with I2C:

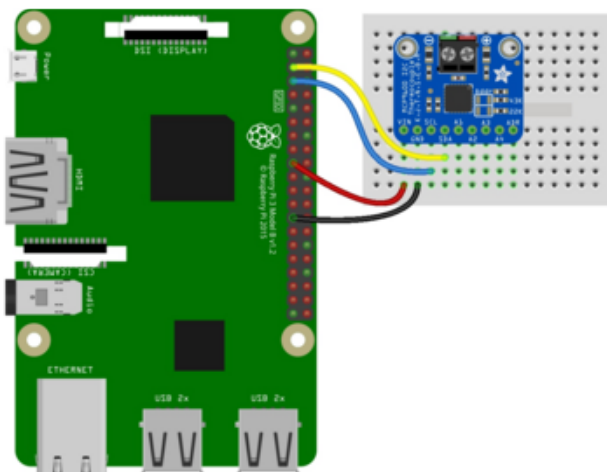

Pi 3V3 to sensor VIN
Pi GND to sensor GND
Pi SCL to sensor SCL
Pi SDA to sensor SDA

Older versions of the Raspberry Pi firmware do not have I2C clock stretching support so they may not work well with the MCP9600. Please ensure your firmware is updated to the latest version before continuing and slow down the

I2C as explained here <https://learn.adafruit.com/circuitpython-on-raspberrypi-linux/i2c-clock-stretching>

CircuitPython Installation of MCP9600 Library

Next you'll need to install the [Adafruit CircuitPython MCP9600 \(https://adafruit.it/GiD\)](https://adafruit.it/GiD) library on your CircuitPython board.

First make sure you are running the [latest version of Adafruit CircuitPython \(https://adafruit.it/Amd\)](https://adafruit.it/Amd) for your board.

Next you'll need to install the necessary libraries to use the hardware--carefully follow the steps to find and install these libraries from [Adafruit's CircuitPython library bundle \(https://adafruit.it/zdx\)](https://adafruit.it/zdx). Our introduction guide has [a great page on how to install the library bundle \(https://adafruit.it/ABU\)](https://adafruit.it/ABU) for both express and non-express boards.

Copy the following files from the library bundle to your **CIRCUITPY** drive:

- `adafruit_mcp9600.mpy`
- `adafruit_bus_device`

Before continuing make sure your board's `lib` folder or root filesystem has the `adafruit_mcp9600.mpy`, and `adafruit_bus_device` files and folders copied over.

Next [connect to the board's serial REPL \(https://adafruit.it/Awz\)](https://adafruit.it/Awz) so you are at the CircuitPython `>>>` prompt.

Python Installation of MCP9600 Library

You'll need to install the `Adafruit_Blinka` library that provides the CircuitPython support in Python. This may also require enabling I2C on your platform and verifying you are running Python 3. [Since each platform is a little different, and Linux changes often, please visit the CircuitPython on Linux guide to get your computer ready \(https://adafruit.it/BSN\)](https://adafruit.it/BSN)!

Once that's done, from your command line run the following command:

- `pip3 install adafruit-circuitpython-mcp9600`

If your default Python is version 3 you may need to run 'pip' instead. Just make sure you aren't trying to use CircuitPython on Python 2.x, it isn't supported!

CircuitPython and Python Usage

To demonstrate the usage of the sensor we'll initialize it and read the temperature from the board's Python REPL.

Run the following code to import the necessary modules and initialize the I2C connection with the sensor. Note that `frequency` must be set when I2C is initialised for the MCP9600 to work:

```
import board
import busio
import adafruit_mcp9600

i2c = busio.I2C(board.SCL, board.SDA, frequency=100000)
mcp = adafruit_mcp9600.MCP9600(i2c)
```

Now you're ready to read values from the sensor using any of these properties:

- **temperature** - The thermocouple or hot junction temperature in degrees Celsius.
- **ambient_temperature** - The ambient or cold-junction temperature in degrees Celsius.
- **delta_temperature** - The difference between the thermocouple (hot junction) and ambient (cold junction) temperatures in degrees Celsius.

```
print(mcp.temperature)
```

```
>>> print(mcp.temperature)
20.1875
```

Full Example Code

```
# SPDX-FileCopyrightText: 2021 ladyada for Adafruit Industries
# SPDX-License-Identifier: MIT

import time
import board
import busio
```

```
import adafruit_mcp9600

i2c = busio.I2C(board.SCL, board.SDA, frequency=100000)
mcp = adafruit_mcp9600.MCP9600(i2c)

while True:
    print((mcp.ambient_temperature, mcp.temperature, mcp.delta_temperature))
    time.sleep(1)
```

Alerts and More

The MCP9600 breakout allows you to configure four separate alerts on four pins. Connect the alert pins to digital output pins on your board or computer, and use the alert configuration in the MCP9600 library to configure them. Check out [the documentation \(https://adafru.it/Ggb\)](https://adafru.it/Ggb) for more information!

Python Docs

[Python Docs \(https://adafru.it/Ggb\)](https://adafru.it/Ggb)

Downloads

Files

- [MCP9600 Datasheet \(https://adafru.it/19Ab\)](https://adafru.it/19Ab)
- [EagleCAD files on GitHub \(https://adafru.it/EYJ\)](https://adafru.it/EYJ)
- [Fritzing object in the Adafruit Fritzing Library \(https://adafru.it/EYK\)](https://adafru.it/EYK)

Schematic

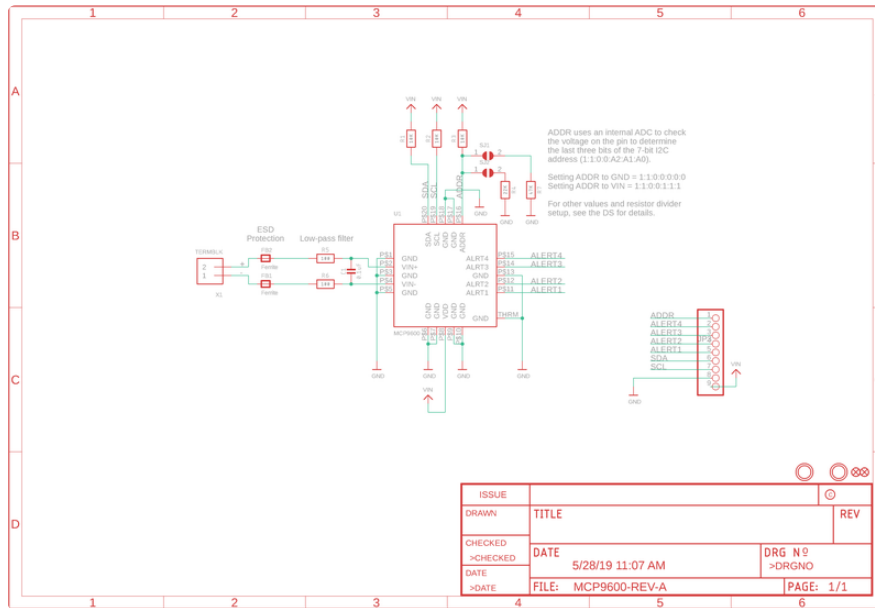

Fab Print

