

# W2SA-P012 ✓ ACTIVE

DEUTSCH | DEUTSCH DT

TE Internal #: W2SA-P012

Secondary Lock, Gray, PBT, 2 Position, -55 – 125 °C [-67 – 257 °F],

DEUTSCH DT

[View on TE.com >](#)



Connectors > Automotive Connectors > Automotive Connector Accessories > Automotive Connector Locks & Position Assurance >

Wedgelocks: DEUTSCH DT

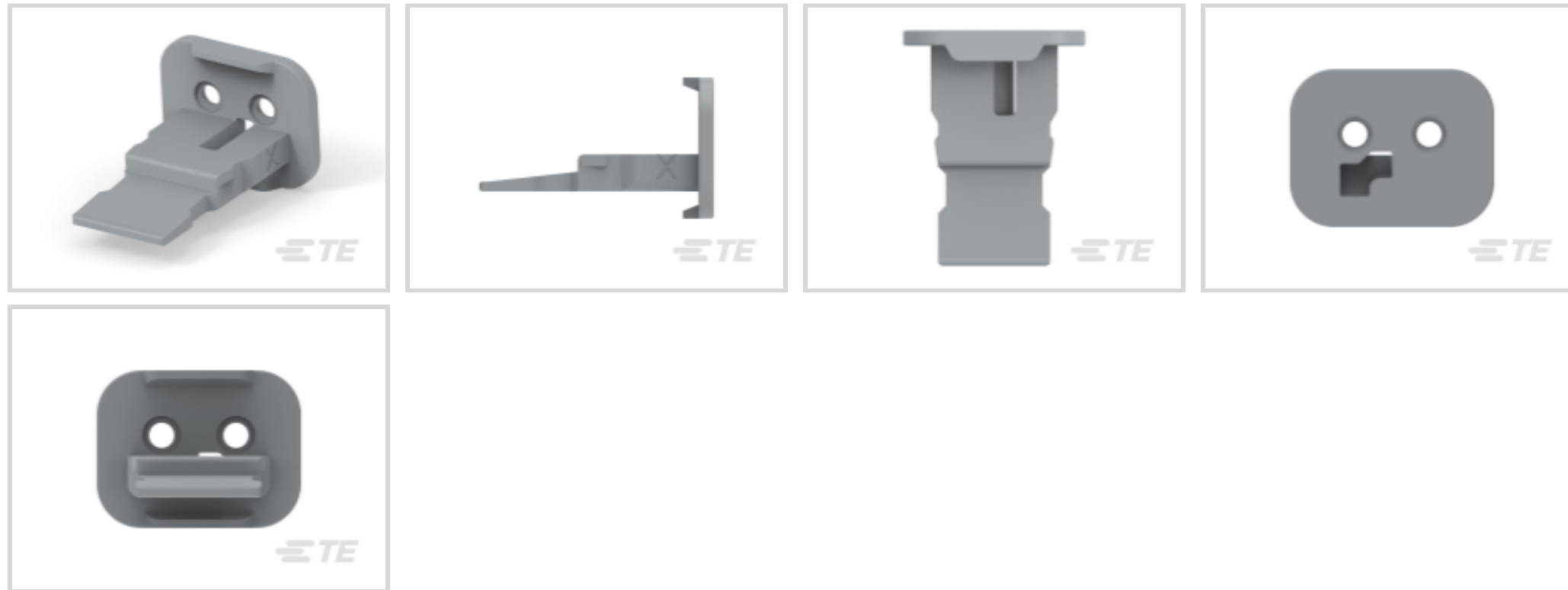

Connector & Contact Retention Accessory Type: **Secondary Lock**

Primary Product Color: **Gray**

Primary Product Material: **PBT**

Number of Positions: **2**

Operating Temperature Range: **-55 – 125 °C [-67 – 257 °F]**

[All Wedgelocks: DEUTSCH DT \(58\)](#)

## Features

### Industry Standards

UL Flammability Rating	UL 94HB
------------------------	---------

### Packaging Features

Packaging Method	Box
Packaging Quantity	1

### Other

Serviceable	Yes
EU RoHS Compliance	Compliant
EU ELV Compliance	Compliant

### Product Type Features

Sealable	No
Connector & Contact Retention Accessory Type	Secondary Lock

### Body Features



Primary Product Color	Gray
-----------------------	------

Primary Product Material	PBT
--------------------------	-----

### Configuration Features

Number of Positions	2
---------------------	---

### Usage Conditions

Operating Temperature Range	-55 – 125 °C[-67 – 257 °F]
-----------------------------	----------------------------

## Product Compliance

[For compliance documentation, visit the product page on TE.com>](#)

EU RoHS Directive 2011/65/EU	Compliant
------------------------------	-----------

EU ELV Directive 2000/53/EC	Compliant
-----------------------------	-----------

China RoHS 2 Directive MIIT Order No 32, 2016	No Restricted Materials Above Threshold
---	---

EU REACH Regulation (EC) No. 1907/2006	Current ECHA Candidate List: JUNE 2024 (241) Candidate List Declared Against: JUNE 2024 (241) Does not contain REACH SVHC
--	---

Halogen Content	Low Halogen - Br, Cl, F, I < 900 ppm per homogenous material. Also BFR/CFR/PVC Free
-----------------	---

Solder Process Capability	Not reviewed for solder process capability
---------------------------	--

#### Product Compliance Disclaimer

This information is provided based on reasonable inquiry of our suppliers and represents our current actual knowledge based on the information they provided. This information is subject to change. The part numbers that TE has identified as EU RoHS compliant have a maximum concentration of 0.1% by weight in homogenous materials for lead, hexavalent chromium, mercury, PBB, PBDE, DBP, BBP, DEHP, DIBP, and 0.01% for cadmium, or qualify for an exemption to these limits as defined in the Annexes of Directive 2011/65/EU (RoHS2). Finished electrical and electronic equipment products will be CE marked as required by Directive 2011/65/EU. Components may not be CE marked. Additionally, the part numbers that TE has identified as EU ELV compliant have a maximum concentration of 0.1% by weight in homogenous materials for lead, hexavalent chromium, and mercury, and 0.01% for cadmium, or qualify for an exemption to these limits as defined in the Annexes of Directive 2000/53/EC (ELV). Regarding the REACH Regulation, the information TE provides on SVHC in articles for this part number is based on the latest European Chemicals Agency (ECHA) 'Guidance on requirements for substances in articles' posted at this URL: <https://echa.europa.eu/guidance-documents/guidance-on-reach>

## Compatible Parts

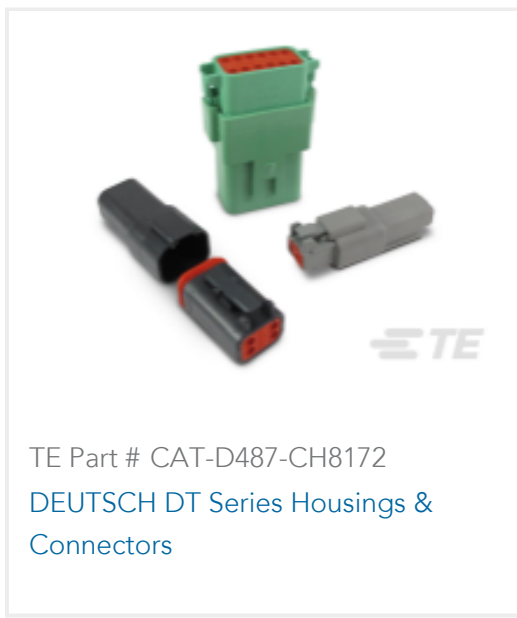

Also in the Series | **DEUTSCH DT**

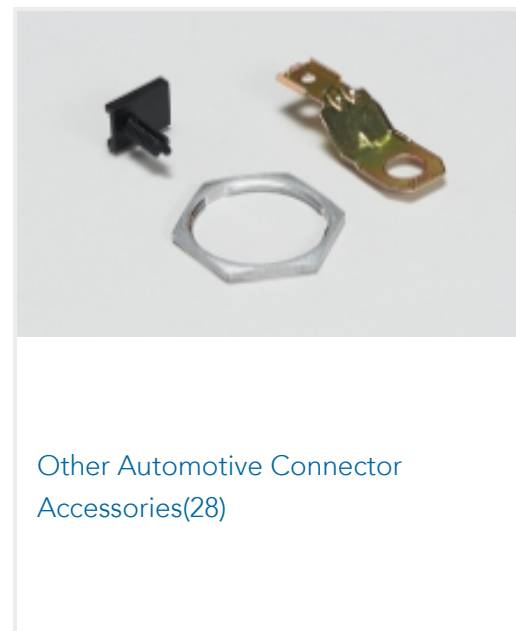
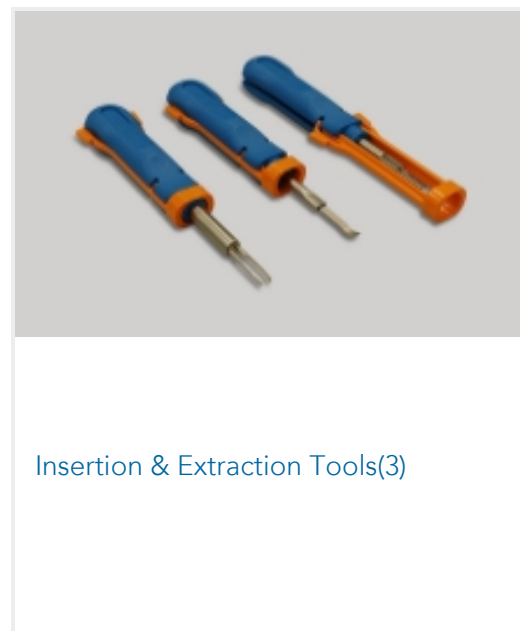
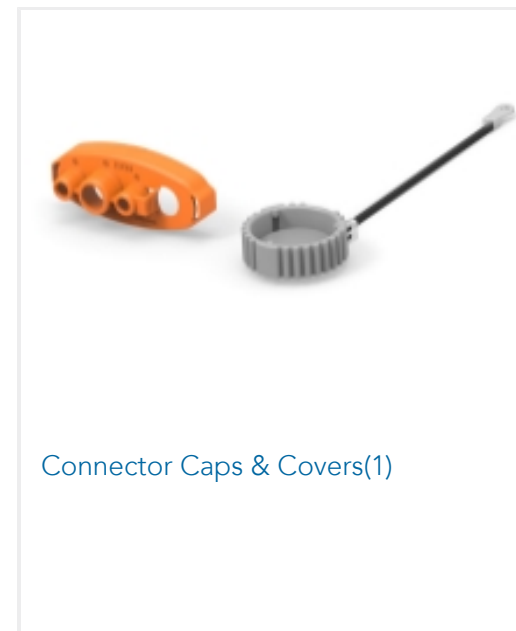
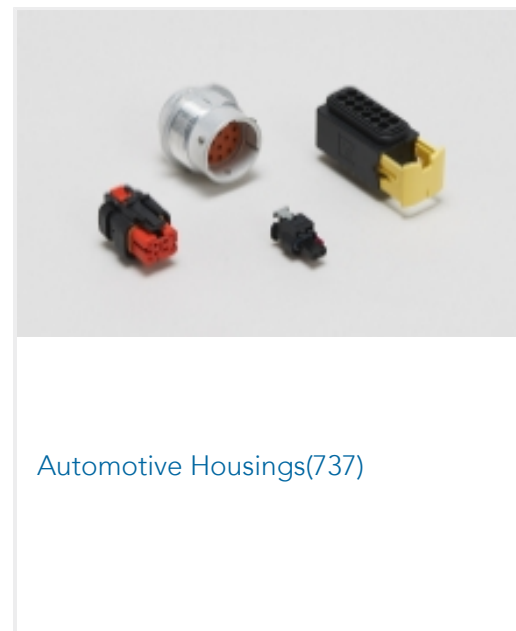
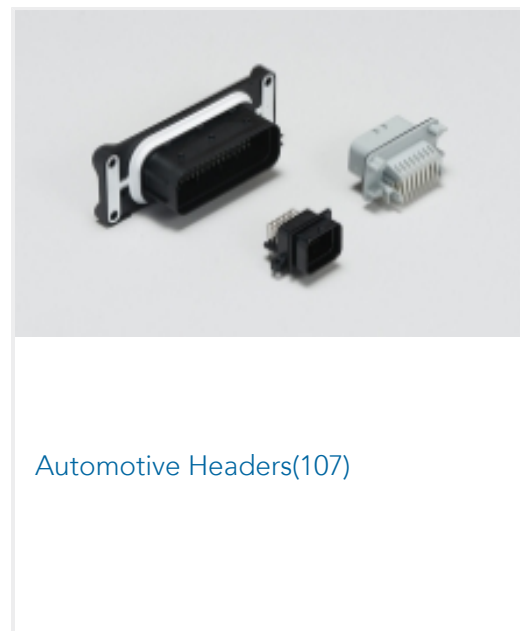

Customers Also Bought





## Documents

### Product Drawings

[WEDGE LOCK, 2P, PLG, GRY, SL RET, DT, A](#)

English

### CAD Files

[3D PDF](#)

3D

Customer View Model

[ENG\\_CVM\\_CVM\\_W2SA-P012\\_E.2d\\_dxf.zip](#)

English

Customer View Model

[ENG\\_CVM\\_CVM\\_W2SA-P012\\_E.3d\\_igs.zip](#)

English

Customer View Model

[ENG\\_CVM\\_CVM\\_W2SA-P012\\_E.3d\\_stp.zip](#)

English

By downloading the CAD file I accept and agree to the [Terms and Conditions](#) of use.

### Datasheets & Catalog Pages

[ICT Terminals and Connectors Catalogue](#)

English

[CONNECTOR SELECTOR](#)

English

### Product Specifications

[Application Specification](#)

English

### Agency Approvals

[UL Report](#)

English