

SEK-18 SV MA STD STR45PR-IN RKZ 20P AUS4

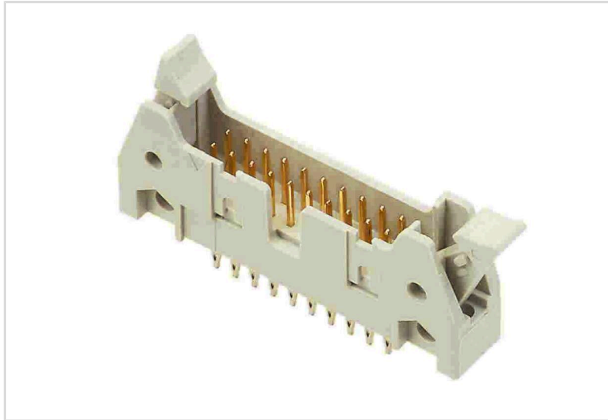

Image is for illustration purposes only. Please refer to product description.

Part number	09 18 520 5919
Specification	SEK-18 SV MA STD STR45PR-IN RKZ 20P AUS4
HARTING eCatalogue	https://b2b.harting.com/09185205919

Identification

Category	Connectors
Series	SEK Standard
Element	Male connector
Description of the contact	Straight

Version

Termination method	Press-in termination
Connection type	PCB to cable
Number of contacts	20
Termination length	4.5 mm
Locking type	With short levers

Technical characteristics

Contact rows	2
Contact spacing (termination side)	2.54 mm
Rated current	1 A
Insulation resistance	$>10^9 \Omega$
Contact resistance	$\leq 20 \text{ m}\Omega$
Limiting temperature	-55 ... +105 °C
Insertion force	$\leq 40 \text{ N}$
Withdrawal force	$\leq 40 \text{ N}$
Performance level	NM 30 (S4)
Mating cycles	≥ 250



Technical characteristics

Test voltage $U_{r.m.s.}$	1 kV
Isolation group	IIIa ($175 \leq CTI < 400$)
PCB thickness	≥ 1.6 mm

Material properties

Material (insert)	Thermoplastic resin (PBT)
Colour (insert)	Grey
Material (contacts)	Copper alloy
Surface (contacts)	Noble metal over Ni Mating side Ni Termination side
Layer thickness	≥ 0.76 μ m
Layer thickness	≥ 30 μ inch
Material flammability class acc. to UL 94	V-0
RoHS	compliant
ELV status	compliant
China RoHS	e
REACH Annex XVII substances	Not contained
REACH ANNEX XIV substances	Not contained
REACH SVHC substances	Not contained
Fire protection on railway vehicles	EN 45545-2 (2020-08)
Requirement set with Hazard Levels	R26

Specifications and approvals

Specifications	IEC 60603-13
UL / CSA	UL 1977 ECBT2.E102079 CSA-C22.2 No. 182.3 ECBT8.E102079
Railway classification	F3/I3

Commercial data

Packaging size	1
Net weight	9.18 g
Country of origin	Czechia
European customs tariff number	85366990
GTIN	5713140029682
ETIM	EC002637

Commercial data

eCl@ss 27460201 PCB connector (board connector)

Recommended configuration of plated through holes

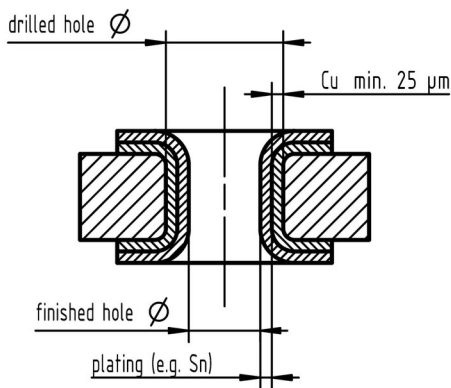

Tin plated PCB (HAL) acc. to EN 60352-5	Drilled hole \varnothing	1,15-0,03 mm
	Cu	min. 25 μm
	Sn	max. 15 μm
	plated hole \varnothing	0,94 - 1,09 mm
Chemical tin plated PCB	Drilled hole \varnothing	1,15-0,03 mm
	Cu	min. 25 μm
	Sn	min. 0,8 μm
	plated hole \varnothing	1,00 - 1,10 mm
Gold /Nickel plated PCB	Drilled hole \varnothing	1,15-0,03 mm
	Cu	min. 25 μm
	Ni	3 - 7 μm
	Au	0,05 - 0,12 μm
	plated hole \varnothing	1,00 - 1,10 mm
Silver plated PCB	Drilled hole \varnothing	1,15-0,03 mm
	Cu	min. 25 μm
	Ag	0,1 - 0,3 μm
	plated hole \varnothing	1,00 - 1,10 mm
Copper plated PCB (OSP)	Drilled hole \varnothing	1,15-0,03 mm
	Cu	min. 25 μm
	plated hole \varnothing	1,00 - 1,10 mm

In addition to the hot-air-level (HAL) other pcb surfaces are getting more important. Due to their different properties, such as mechanical strength and coefficient of friction we recommend the above mentioned configuration of pcb through holes.