



Image for illustrative purpose only

## Summary

[Request a quote](#)

[Catalog](#)

Number of contacts Low Voltage	6
Wire Size/AWG	28 - 20
Gender	Standard
Socket / Receptacle	Socket / Receptacle - Fixed Panel Front Mounted
Locking system	Threaded
Size	2W
Suggested matching part	<a href="#">FVG.2W.306.CLAC50</a>
Series	W - Underwater

[https://www.lemo.com/int\\_en/solutions/supreme/w-underwater/hvg-2w-306-cllpv.html](https://www.lemo.com/int_en/solutions/supreme/w-underwater/hvg-2w-306-cllpv.html)

LEMO products and services are provided "as is". LEMO makes no warranties or representations with regard to LEMO product & services or use of them, express, implied or statutory, including for accuracy, completeness, or security. The user is fully responsible for his products and applications using LEMO components.

# Technical details

## Electrical Configuration

Contact Termination Low voltage	Solder
R (max)	3.6 mOhm
Insert configuration value	2W.306 - 6 Low Voltage
Rated current	12 A
Vtest (contact-contact)	1350 V (AC) 1900 V (DC)
Vtest (contact-shell)	1450 V (AC) 2100 V (DC)
Contact Type	Solder
Max. Solid Conductor	0.5 mm <sup>2</sup> (AWG 20)
Max. Stranded Conductor	0.5 mm <sup>2</sup> (AWG 20)
Bucket Dia.	1 mm (0.039in)
Contact Dia.	1.3 mm (0.051in)
Number of contacts Low Voltage	6
Wire Size/AWG	28 - 20
Gender	Standard

## Form & Material

Shell style / Model id	HV - Fixed socket, nut fixing, vacuumtight
Socket / Receptacle	Fixed Panel Front Mounted
Housing material	Brass (chrome plated [SAE AMS 2460]) shell and collet nut, nickel plated [SAE AMS QQ N 290] brass latch sleeve and mid pieces
Locking system	Threaded
Keying	G: 1 key (alpha=0, Plug: male contacts, Receptacle: female contacts)
Colour	Grey
Variant	Watertight / Vacuum-tested unmated (connector to device)
Weight	28.94 g

[https://www.lemo.com/int\\_en/solutions/supreme/w-underwater/hvg-2w-306-cllpv.html](https://www.lemo.com/int_en/solutions/supreme/w-underwater/hvg-2w-306-cllpv.html)

LEMO products and services are provided "as is". LEMO makes no warranties or representations with regard to LEMO product & services or use of them, express, implied or statutory, including for accuracy, completeness, or security. The user is fully responsible for his products and applications using LEMO components.

## Environment

Technical domain	Specialties and Other
Environmental sealing (IP rating)	Hermetic unmated
Endurance	1000 mating cycles
Temperature range	-20°C / +80°C
Climatical Category	20/200/21
Humidity (max)	<=95% [at 60 deg C /140 F]
Shielding (min)	95 dB (10 MHz)
Shielding (min)	80 dB (1 GHz)
Pressure	40 bars
R leak (He) (max)	0.0000001 mbar*/s (if vacuum-tested)
Salt Spray Corrosion	>1000 hr

## Drawings

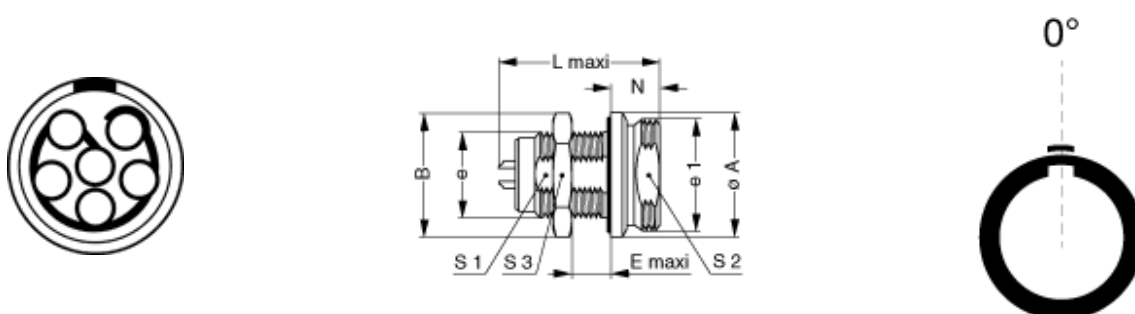

## Dimensions

	<b>A</b>	<b>B</b>	<b>e</b>	<b>e1</b>	<b>E</b>	<b>L</b>	<b>N</b>	<b>S1</b>	<b>S2</b>	<b>S3</b>
mm.	22.5	21.8	M16x1.0	M20x1.0	12	35.8	9	14.5	18.5	19
in.	0.89	0.86			0.47	1.41	0.35	0.57	0.73	0.75

## Recommended By Lemo

### Accessories



Compatible cap

[BRE.2V.200.NAV](#)

[https://www.lemo.com/int\\_en/solutions/supreme/w-underwater/hvg-2w-306-cllpv.html](https://www.lemo.com/int_en/solutions/supreme/w-underwater/hvg-2w-306-cllpv.html)





LEMO products and services are provided "as is". LEMO makes no warranties or representations with regard to LEMO product & services or use of them, express, implied or statutory, including for accuracy, completeness, or security. The user is fully responsible for his products and applications using LEMO components.

# Cables

Cable PartNumber	Material	Colour	Cable image
CMN.06.T20.062PGZE		grey	
CMN.06.T20.062PNZE			
CMN.06.T20.062QGZE	TPR (medical)	Grey	
CMN.06.T26.037QGZE	TPR (medical)	Grey	
CMN.06.T28.031PGCE	PVC	GREY	
CMN.06.T28.031PGZE		grey	
CMN.06.T28.031PNCE	PVC	Black	
CMN.06.T28.031PNZE			
CMN.06.T28.042QBCE	TPR (medical)		
CMN.06.T28.044PGZE		grey	
CMN.06.T28.044PNZE			
106220	PVC	Black	
106240	PTFE	White	
12080	PVC	Grey	
160140	PVC	Grey	
160240	PVC	Black	
160260	PVC	Black	
260250	PVC	Grey	

[https://www.lemo.com/int\\_en/solutions/supreme/w-underwater/hvg-2w-306-cllpv.html](https://www.lemo.com/int_en/solutions/supreme/w-underwater/hvg-2w-306-cllpv.html)

LEMO products and services are provided "as is". LEMO makes no warranties or representations with regard to LEMO product & services or use of them, express, implied or statutory, including for accuracy, completeness, or security. The user is fully responsible for his products and applications using LEMO components.

Cable PartNumber	Material	Colour	Cable image
360500	PVC	Grey	
360750	PVC	Grey	
60260	PTFE	White	
6280	PVC	Black	

[https://www.lemo.com/int\\_en/solutions/supreme/w-underwater/hvg-2w-306-cllpv.html](https://www.lemo.com/int_en/solutions/supreme/w-underwater/hvg-2w-306-cllpv.html)

LEMO products and services are provided "as is". LEMO makes no warranties or representations with regard to LEMO product & services or use of them, express, implied or statutory, including for accuracy, completeness, or security. The user is fully responsible for his products and applications using LEMO components.