



Image for illustrative purpose only

Summary

[Request a quote](#)

[Catalog](#)

Number of contacts Low Voltage	2
Wire Size/AWG	22 - 14
Gender	Standard
Plug	Plug - Fixed
Locking system	Push-pull
Size	2B
Suggested matching part	EGG.2B.302.CLL
Series	B - Indoor keyed

https://www.lemo.com/int_en/solutions/originals/b-indoor-keyed/fwg-2b-302-cla.html

LEMO products and services are provided "as is". LEMO makes no warranties or representations with regard to LEMO product & services or use of them, express, implied or statutory, including for accuracy, completeness, or security. The user is fully responsible for his products and applications using LEMO components.

Technical details

Electrical Configuration

Contact Termination Low voltage	Solder
R (max)	3.3 mOhm
Insert configuration value	2B.302 - 2 Low Voltage
Insulator	L: PEEK (UL 94 / V-0/1.5)
Rated current	25 A
Vtest (contact-contact)	2100 V (AC), 2970 V (DC)
Vtest (contact-shell)	1750 V (AC), 2500 V (DC)
Contact Type	Solder
Max. Solid Conductor	1.5 mm ² (AWG 14)
Max. Stranded Conductor	1.5 mm ² (AWG 16)
Bucket Dia.	1.8 mm (0.071in)
Contact Dia.	2 mm (0.079in)
Number of contacts Low Voltage	2
Wire Size/AWG	22 - 14
Gender	Standard

Form & Material

Shell style / Model id	FW - Fixed plug, nut fixing
Plug	Fixed
Housing material	Brass (chrome plated [SAE AMS 2460]) shell and collet nut, nickel plated [SAE AMS QQ N 290] brass latch sleeve and mid pieces
Locking system	Push-pull
Keying	G: 1 key (alpha=0, plug: male contacts, receptacle: female contacts)
Colour	Grey
Weight	18.55 g

https://www.lemo.com/int_en/solutions/originals/b-indoor-keyed/fwg-2b-302-cla.html

LEMO products and services are provided "as is". LEMO makes no warranties or representations with regard to LEMO product & services or use of them, express, implied or statutory, including for accuracy, completeness, or security. The user is fully responsible for his products and applications using LEMO components.

Environment

Technical domain	Audio Video, Energy and Industrial, Medical, Semiconductor, Specialties and Other, Test and Measurement, Transportation, Aerospace and UAV
Environmental sealing (IP rating)	IP50
Endurance	5000 mating cycles
Temperature range	-55°C / +250°C
Climatical Category	50/175/21
Humidity (max)	<=95% [at 60 deg C /140 F]
Shielding (min)	75 dB (10 MHz)
Shielding (min)	40 dB (1 GHz)
Shock Resistance	100 g [6 ms]
Vibration	15 g [10 Hz - 2000 Hz]
Salt Spray Corrosion	>1000 hr

Cable fixation

Cable termination protection	Standard back nut (no additional protection)
Fixation type	Cable collet

Drawings

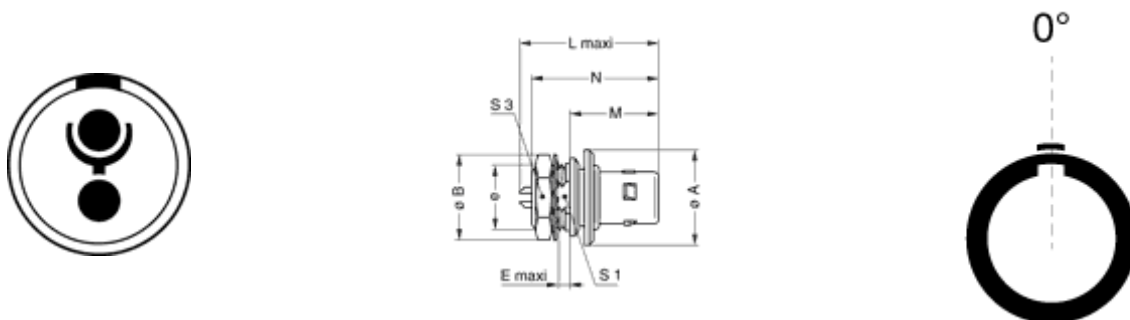

Dimensions

	A	B	e	E	L	M	N	S1	S3
mm.	19.5	19.5	M15x1.0	4.1	33.6	18	27.3	13.5	17
in.	0.77	0.77		0.16	1.32	0.71	1.07	0.53	0.67

https://www.lemo.com/int_en/solutions/originals/b-indoor-keyed/fwg-2b-302-cla.html

LEMO products and services are provided "as is". LEMO makes no warranties or representations with regard to LEMO product & services or use of them, express, implied or statutory, including for accuracy, completeness, or security. The user is fully responsible for his products and applications using LEMO components.

Recommended By Lemo

Tools







































Spanner

[DCA.91.231.7TN](#)

https://www.lemo.com/int_en/solutions/originals/b-indoor-keyed/fwg-2b-302-cla.html

LEMO products and services are provided "as is". LEMO makes no warranties or representations with regard to LEMO product & services or use of them, express, implied or statutory, including for accuracy, completeness, or security. The user is fully responsible for his products and applications using LEMO components.

Cables

Cable PartNumber	Material	Colour	Cable image
CMN.02.T14.072PGZE		grey	
CMN.02.T14.072PNZE		black	
CMN.02.T14.072QGZE	TPR (medical)	Grey	
CMN.02.T14.078PGZE		grey	
CMN.02.T14.078PNZE			
CMN.02.T18.064UNCU			
CMN.02.T20.047PGZE		grey	
CMN.02.T20.047PNZE			
CMN.02.T20.048QGZE	TPR (medical)	Grey	
CMN.02.T28.030PGCE	PVC	GREY	
CMN.02.T28.030PGZE		grey	
CMN.02.T28.030PNCE	PVC	Black	
CMN.02.T28.030PNZE			
102080	PVC	Grey	
120184	PVC	Black	
120240	PVC	Black	
120250	PVC	Grey	
120500	PVC	Grey	
120501	PVC	Grey	
120751	PVC	Grey	
20140	PVC	Grey	
20140	PVC	Grey	
20141	PVC	Grey	
20142	PVC	Red	
20143	PVC	Green	
20144	PVC	Black	
20145	PVC	Yellow	
20146	PVC	Black	
20240	PTFE	White	
20260	PVC	Black	
20264	PVC	Black	
20266	PVC	Violet	
2050	PVC	Black	
20550	PUR	Black	
20560	PUR	White	
2080	PVC	Grey	
220151	PVC	Grey	
220750	PVC	Grey	
2221	PVC	Black	
2260	PTFE	White	
2280	PVC	Black	
320150	PVC	Grey	
4082	PVC	Grey	
CMB.02.210.635	PUR	Black	

https://www.lemo.com/int_en/solutions/originals/b-indoor-keyed/fwg-2b-302-cla.html

LEMO products and services are provided "as is". LEMO makes no warranties or representations with regard to LEMO product & services or use of them, express, implied or statutory, including for accuracy, completeness, or security. The user is fully responsible for his products and applications using LEMO components.