

*Image for illustrative purpose only*

## Summary

[Request a quote](#)

[Catalog](#)

Number of contacts Low Voltage	6
Wire Size/AWG	30 - 22
Gender	Reverse Gender
Socket / Receptacle	Socket / Receptacle - Free
Locking system	Push-pull
Jacket cable outside diameter [mm]	3.10 - 4.20 mm
Size	1B
Suggested matching part	<a href="#">FGJ.1B.306.CLLD35</a>
Series	B - Indoor keyed

[https://www.lemo.com/int\\_en/solutions/originals/b-indoor-keyed/phj-1b-306-clad35.html](https://www.lemo.com/int_en/solutions/originals/b-indoor-keyed/phj-1b-306-clad35.html)

LEMO products and services are provided "as is". LEMO makes no warranties or representations with regard to LEMO product & services or use of them, express, implied or statutory, including for accuracy, completeness, or security. The user is fully responsible for his products and applications using LEMO components.

# Technical details

## Electrical Configuration

Contact Termination Low voltage	Solder
R (max)	6.1 mOhm
Insert configuration value	1B.306 - 6 Low Voltage
Insulator	L: PEEK (UL 94 / V-0/1.5)
Rated current	7 A
Vtest (contact-contact)	1050 V (AC), 1490 V (DC)
Vtest (contact-shell)	1200 V (AC), 1700 V (DC)
Contact Type	Solder
Max. Conductor	0.34 mm <sup>2</sup> (AWG 22)
Max. Stranded Conductor	0.34 mm <sup>2</sup> (AWG 22)
Bucket Dia.	0.8 mm (0.031in)
Contact Dia.	0.7 mm (0.028in)
Number of contacts Low Voltage	6
Wire Size/AWG	30 - 22
Gender	Reverse Gender

## Form & Material

Shell style / Model id	PH - Free receptacle, cable collet
Socket / Receptacle	Free
Housing material	Brass (chrome plated [SAE AMS 2460]) shell and collet nut, nickel plated [SAE AMS QQ N 290] brass latch sleeve and mid pieces
Locking system	Push-pull
Keying	2 keys (gamma=45, plug: female contacts, receptacle: male contacts)
Colour	Grey

[https://www.lemo.com/int\\_en/solutions/originals/b-indoor-keyed/phj-1b-306-clad35.html](https://www.lemo.com/int_en/solutions/originals/b-indoor-keyed/phj-1b-306-clad35.html)

LEMO products and services are provided "as is". LEMO makes no warranties or representations with regard to LEMO product & services or use of them, express, implied or statutory, including for accuracy, completeness, or security. The user is fully responsible for his products and applications using LEMO components.

## Environment

Technical domain	Audio Video, Energy and Industrial, Medical, Semiconductor, Specialties and Other, Test and Measurement, Transportation, Aerospace and UAV
Environmental sealing (IP rating)	IP50
Endurance	5000 mating cycles
Temperature range	-55°C / +250°C
Climatical Category	50/175/21
Humidity (max)	<=95% [at 60 deg C /140 F]
Shielding (min)	75 dB (10 MHz)
Shielding (min)	40 dB (1 GHz)
Shock Resistance	100 g [ 6 ms]
Vibration	15 g [10 Hz - 2000 Hz]
Salt Spray Corrosion	>1000 hr

## Cable fixation

Cable termination protection	Standard back nut (no additional protection)
Fixation type	Cable collet
Jacket cable outside diameter [mm]	3.10 - 4.20 mm

## Drawings

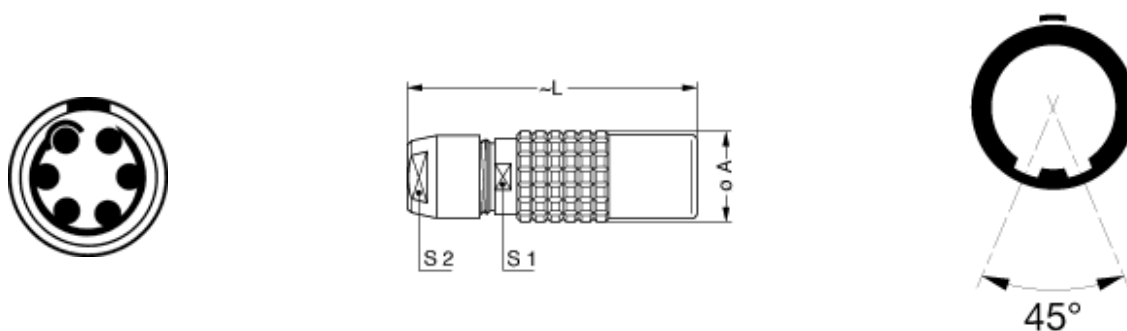

## Dimensions

	S1	L	A	S2
mm.	10	40.5	12.5	9
in.	0.39	1.59	0.49	0.35

[https://www.lemo.com/int\\_en/solutions/originals/b-indoor-keyed/phj-1b-306-clad35.html](https://www.lemo.com/int_en/solutions/originals/b-indoor-keyed/phj-1b-306-clad35.html)

LEMO products and services are provided "as is". LEMO makes no warranties or representations with regard to LEMO product & services or use of them, express, implied or statutory, including for accuracy, completeness, or security. The user is fully responsible for his products and applications using LEMO components.







# Recommended By Lemo

## Accessories

Compatible cap

[BRF.1S.200.NAS](#)

## Cables

Cable PartNumber	Material	Colour	Cable image
CMN.06.T26.037QGZE	TPR (medical)	Grey	
CMN.06.T28.031PGCE	PVC	GREY	
CMN.06.T28.031PGZE		grey	
CMN.06.T28.031PNCE	PVC	Black	
CMN.06.T28.031PNZE			
CMN.06.T28.042QBCE	TPR (medical)		
60260	PTFE	White	

[https://www.lemo.com/int\\_en/solutions/originals/b-indoor-keyed/phj-1b-306-clad35.html](https://www.lemo.com/int_en/solutions/originals/b-indoor-keyed/phj-1b-306-clad35.html)

LEMO products and services are provided "as is". LEMO makes no warranties or representations with regard to LEMO product & services or use of them, express, implied or statutory, including for accuracy, completeness, or security. The user is fully responsible for his products and applications using LEMO components.