



*Image for illustrative purpose only*

## Summary

[Request a quote](#)

[Catalog](#)

Number of contacts Low Voltage	6
Wire Size/AWG	32 - 28
Gender	Reverse Gender
Socket / Receptacle	Socket / Receptacle - Fixed Panel Rear Mounted
Locking system	Push-pull
Jacket cable outside diameter [mm]	1.00 - 8.30 mm
Size	0T
Series	T - Small Outdoor keyed

[https://www.lemo.com/int\\_en/solutions/originals/t-outdoor-keyed/eel-0t-306-cyc.html](https://www.lemo.com/int_en/solutions/originals/t-outdoor-keyed/eel-0t-306-cyc.html)

LEMO products and services are provided "as is". LEMO makes no warranties or representations with regard to LEMO product & services or use of them, express, implied or statutory, including for accuracy, completeness, or security. The user is fully responsible for his products and applications using LEMO components.

# Technical details

## Electrical Configuration

Contact Termination Low voltage	Crimp
R (max)	8.7 mOhm
Insert configuration value	0T.306 - 6 Low Voltage
Insulator	Y: PEEK for crimp contacts
Rated current	2.5 A
Vtest (contact-contact)	1400 V (AC), 1980 V (DC)
Vtest (contact-shell)	1200 V (AC), 1700 V (DC)
Contact retention	12 N
Contact Type	Crimp
Max. Conductor	0.09 mm <sup>2</sup> (AWG 28)
Min. Conductor	0.035 mm <sup>2</sup> (AWG 32)
Bucket Dia.	0.45 mm (0.018in)
Contact Dia.	0.5 mm (0.02in)
Number of contacts Low Voltage	6
Wire Size/AWG	32 - 28
Gender	Reverse Gender

## Form & Material

Shell style / Model id	EE - Fixed receptacle, nut fixing, back panel mounting
Socket / Receptacle	Fixed Panel Rear Mounted
Housing material	Brass (chrome plated [SAE AMS 2460]) shell and collet nut, nickel plated [SAE AMS QQ N 290] brass latch sleeve and mid pieces
Locking system	Push-pull
Keying	L: 2 keys (gamma=80, plug: female contacts, receptacle: male contacts)
Colour	Grey
Weight	5.07 g

[https://www.lemo.com/int\\_en/solutions/originals/t-outdoor-keyed/eel-0t-306-cyc.html](https://www.lemo.com/int_en/solutions/originals/t-outdoor-keyed/eel-0t-306-cyc.html)

LEMO products and services are provided "as is". LEMO makes no warranties or representations with regard to LEMO product & services or use of them, express, implied or statutory, including for accuracy, completeness, or security. The user is fully responsible for his products and applications using LEMO components.

## Environment

Technical domain	Energy and Industrial, Test and Measurement
Environmental sealing (IP rating)	IP68
Endurance	>3000 mating cycles
Temperature range	-55°C / +200°C
Climatical Category	50/175/21
Humidity (max)	<=95% [at 60 deg C /140 F]
Resistance to vibration	15 g [10 Hz - 2000 Hz]
Shock Resistance	100 g [ 6 ms]
Salt Spray Corrosion	>1000 hr

## Cable fixation

Jacket cable outside diameter [mm]	1.00 - 8.30 mm
------------------------------------	----------------

## Drawings

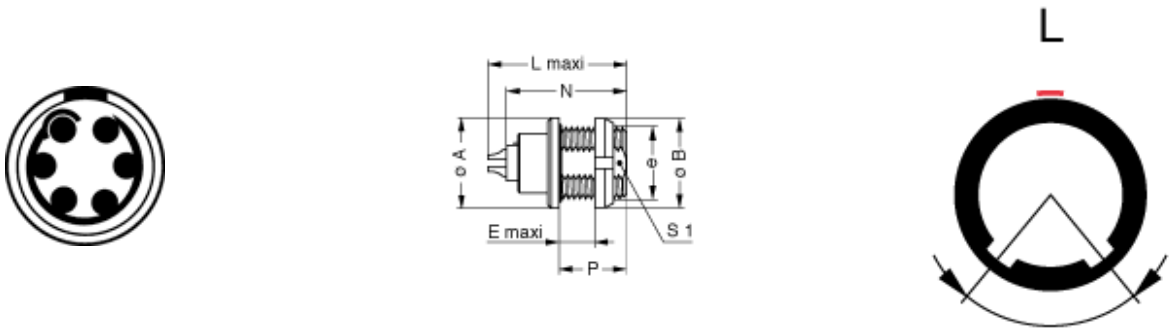

## Dimensions

	<b>A</b>	<b>B</b>	<b>e</b>	<b>E</b>	<b>Lmax</b>	<b>Nmax</b>	<b>S1</b>	<b>P</b>
mm.	12	12	M9x0.6	6.5	21	19.1	8.2	9
in.	0.47	0.47		0.26	0.83	0.75	0.32	0.35

[https://www.lemo.com/int\\_en/solutions/originals/t-outdoor-keyed/eel-0t-306-cyc.html](https://www.lemo.com/int_en/solutions/originals/t-outdoor-keyed/eel-0t-306-cyc.html)

LEMO products and services are provided "as is". LEMO makes no warranties or representations with regard to LEMO product & services or use of them, express, implied or statutory, including for accuracy, completeness, or security. The user is fully responsible for his products and applications using LEMO components.

# Recommended By Lemo

## Accessories

Replacement contact [FGG.0B.554.ZZC](#)

Compatible cap [BRE.0T.200.CAZ](#)

## Tools







Positionner [DCE.91.050.BVC](#)

Extraction tool [DCC.05.02B.LAG](#)

Crimp tool [DPC.91.701.V](#)

Spanner wrench [Socket for torque wrench DCM.0S.M09.4](#)

# Cables

Cable PartNumber	Material	Colour	Cable image
CMN.06.T28.031PGCE	PVC	GREY	
CMN.06.T28.031PGZE		grey	
CMN.06.T28.031PNCE	PVC	Black	
CMN.06.T28.031PNZE			
CMN.06.T28.042QBCE	TPR (medical)		
CMN.06.T28.044PGZE		grey	
CMN.06.T28.044PNZE			
12080	PVC	Grey	
6280	PVC	Black	

[https://www.lemo.com/int\\_en/solutions/originals/t-outdoor-keyed/eel-0t-306-cyc.html](https://www.lemo.com/int_en/solutions/originals/t-outdoor-keyed/eel-0t-306-cyc.html)

LEMO products and services are provided "as is". LEMO makes no warranties or representations with regard to LEMO product & services or use of them, express, implied or statutory, including for accuracy, completeness, or security. The user is fully responsible for his products and applications using LEMO components.