

CUSTOMER PRINT

PART NUMBER: W8880-XSG-P-5XX

- NOTES:
 1. ALL PARTS TO BE BULK PACKED.
 2. CONTACTS SHIPPED UNASSEMBLED
 3. DIMENSIONS ARE REFERENCE EXCEPT THOSE WITH A TOLERANCE

ASS'Y P/N	CABLE O.D.
W8880-XSG-P-513	130-.150 [3.3-3.8]
W8880-XSG-P-516	.160-.180 [4.1-4.6]
W8880-XSG-P-519	.190-.210 [4.8-5.3]
W8880-XSG-P-522	.220-.250 [5.6-6.3]
W8880-XSG-P-526	.250-.270 [6.3-6.9]
W8880-XSG-P-528	.265-.285 [6.7-7.2]

ASSEMBLY P/N	CONTACT QTY
W8880-8SG-P-5XX	8
W8880-9SG-P-5XX	9
W8880-10SG-P-5XX	10
W8880-XSG-P-5XX	

GROMMET SIZE
 NUMBER OF CONTACTS

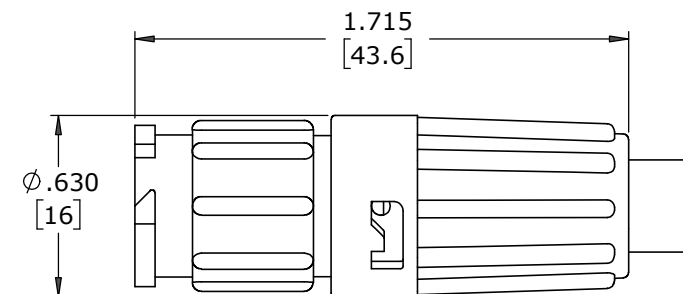

SHOW ASSEMBLED
 FOR CUSTOMER REFERENCE ONLY

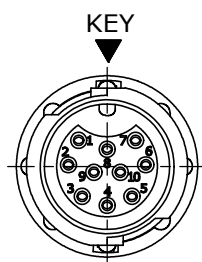

MATING FACE
 W8880-10SG-P-5XX SHOWN

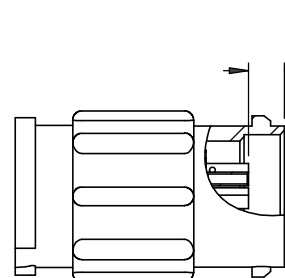

.125±.015
 [3.2±0.4]
 CONTACT HEIGHT

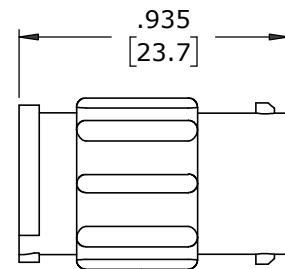

CABLE-TO-CABLE HOUSING
 MAT'L: UV PBT, BLACK

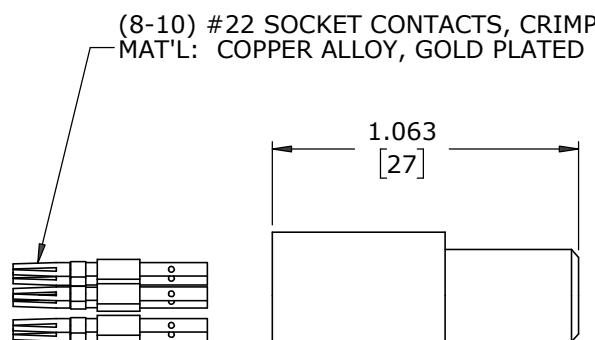

(8-10) #22 SOCKET CONTACTS, CRIMP
 MAT'L: COPPER ALLOY, GOLD PLATED

GROMMET
 MAT'L: SANTOPRENE, BLACK

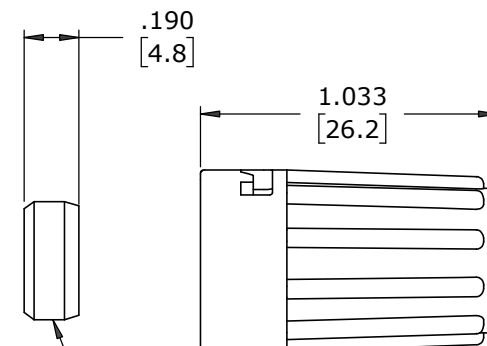

CABLE GRIP
 MAT'L: POLYPROPYLENE, BLACK

BACKSHELL
 MAT'L: UV PBT, BLACK

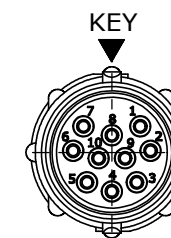

WIRING END
 W8880-10SG-P-5XX SHOWN
 WITHOUT HARDWARE

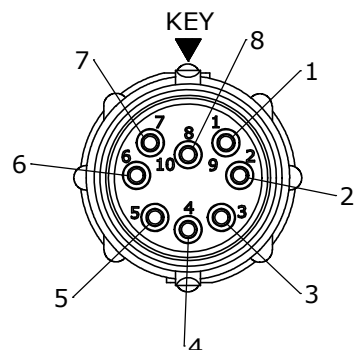

WIRING END
 W8880-8SG-P-5XX

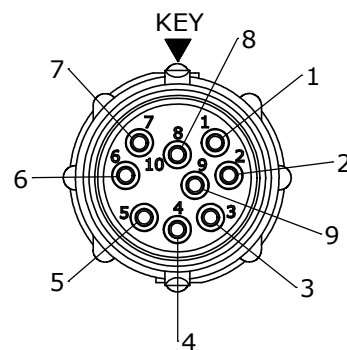

WIRING END
 W8880-9SG-P-5XX

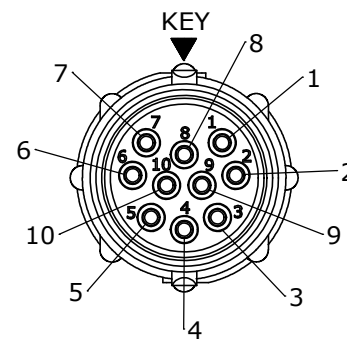

WIRING END
 W8880-10SG-P-5XX

DIMENSIONS IN BRACKETS [] ARE IN MILLIMETERS

CUSTOMER APPROVAL

THIS DOCUMENT CONTAINS CONFIDENTIAL INFORMATION PROPRIETARY TO CONXALL CORPORATION. ANY REPRODUCTION, DISCLOSURE, OR USE OF THIS DOCUMENT /INFORMATION IS EXPRESSLY PROHIBITED UNLESS AUTHORIZED IN WRITING BY CONXALL CORPORATION.

APPROVED BY: _____
 DATE: _____

RoHS COMPLIANT

MA	07-14-20	RELEASED PER PDR 16014-10
PNK	03-20-18	PDR 16014
REV.	INIT.	DATE
DESCRIPTION		ORIG. DRAWN BY: PNK
ALL INFORMATION ILLUSTRATED IS THE PROPERTY OF "CONXALL CORPORATION". UNAUTHORIZED DUPLICATION OR DISTRIBUTION OF THIS DOCUMENT IS PROHIBITED.		DATE: 03-20-18
APPROVED BY:		CHECKED BY:
ALL UNITS ARE IN FEET, INCHES, FRACTION OF INCHES AND DECIMALS.		UNLESS OTHERWISE SPECIFIED TOLERANCES: 3 PLACE DECIMALS ±.010 ANGLES ±1° FRACTIONS ±1/16
SCALE	SIZE	SHEET
NTS	B	1 OF 1
FILE:	DIRECTORY:	PART NUMBER:
W8880-XSG-P-5XX	SLW	W8880-XSG-P-5XX
TITLE: CABLE-TO-CABLE ASSEMBLY (8-10) #22 SOCKET CONTACTS, CRIMP INSTA-CLICK™ MINI-CON-X		CUSTOMER: STANDARD PRODUCT
REV A		REV A