



Image for illustrative purpose only

## Summary

[Request a quote](#)

[Catalog](#)

Number of contacts Low Voltage	7
Wire Size/AWG	34 - 28
Gender	Standard
Plug	Plug - Fixed
Locking system	Snap-on
Size	0B
Suggested matching part	<a href="#">PHG.0B.307.CLLD32</a>
Series	B - Indoor keyed

[https://www.lemo.com/int\\_en/solutions/originals/b-indoor-keyed/fag-0b-307-cla.html](https://www.lemo.com/int_en/solutions/originals/b-indoor-keyed/fag-0b-307-cla.html)

LEMO products and services are provided "as is". LEMO makes no warranties or representations with regard to LEMO product & services or use of them, express, implied or statutory, including for accuracy, completeness, or security. The user is fully responsible for his products and applications using LEMO components.

# Technical details

## Electrical Configuration

Contact Termination Low voltage	Solder
R (max)	8.7 mOhm
Insert configuration value	0B.307 - 7 Low Voltage
Insulator	L: PEEK (UL 94 / V-0/1.5)
Rated current	2.5 A
Vtest (contact-contact)	800 V (AC), 1130 V (DC)
Vtest (contact-shell)	700 V (AC), 990 V (DC)
Contact Type	Solder
Max. Solid Conductor	0.09 mm <sup>2</sup> (AWG 28)
Max. Stranded Conductor	0.09 mm <sup>2</sup> (AWG 28)
Bucket Dia.	0.45 mm (0.018in)
Contact Dia.	0.5 mm (0.02in)
Number of contacts Low Voltage	7
Wire Size/AWG	34 - 28
Gender	Standard

## Form & Material

Shell style / Model id	FA - Fixed plug, non-latching, nut fixing
Plug	Fixed
Housing material	Brass (chrome plated [SAE AMS 2460]) shell and collet nut, nickel plated [SAE AMS QQ N 290] brass latch sleeve and mid pieces
Locking system	Snap-on
Keying	G: 1 key (alpha=0, plug: male contacts, receptacle: female contacts)
Colour	Grey
Weight	5.14 g

[https://www.lemo.com/int\\_en/solutions/originals/b-indoor-keyed/fag-0b-307-cla.html](https://www.lemo.com/int_en/solutions/originals/b-indoor-keyed/fag-0b-307-cla.html)

LEMO products and services are provided "as is". LEMO makes no warranties or representations with regard to LEMO product & services or use of them, express, implied or statutory, including for accuracy, completeness, or security. The user is fully responsible for his products and applications using LEMO components.

## Environment

Technical domain	Audio Video, Energy and Industrial, Medical, Semiconductor, Specialties and Other, Test and Measurement, Transportation, Aerospace and UAV
Environmental sealing (IP rating)	IP50
Endurance	5000 mating cycles
Temperature range	-55°C / +250°C
Climatical Category	50/175/21
Humidity (max)	<=95% [at 60 deg C /140 F]
Shielding (min)	75 dB (10 MHz)
Shielding (min)	40 dB (1 GHz)
Shock Resistance	100 g [ 6 ms]
Vibration	15 g [10 Hz - 2000 Hz]
Salt Spray Corrosion	>1000 hr

## Drawings

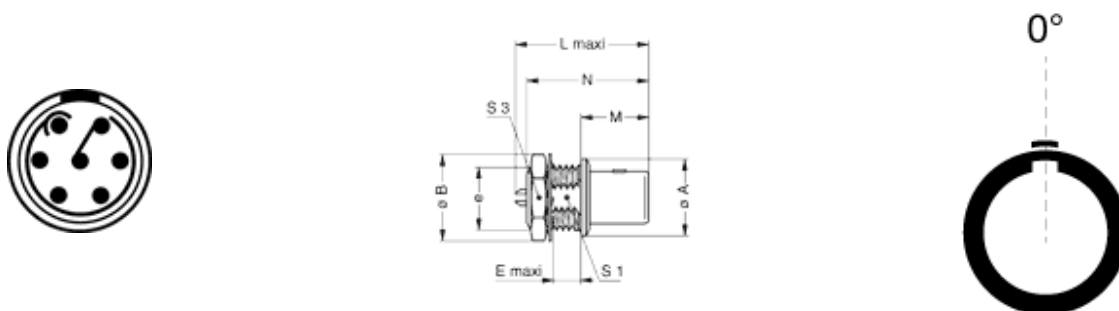

## Dimensions

	A	B	e	E	L	M	N	S1	S3
mm.	10	12.5	M9x0.6	4.2	20.8	11.5	18.9	8.2	11
in.	0.39	0.49		0.17	0.82	0.45	0.74	0.32	0.43

[https://www.lemo.com/int\\_en/solutions/originals/b-indoor-keyed/fag-0b-307-cla.html](https://www.lemo.com/int_en/solutions/originals/b-indoor-keyed/fag-0b-307-cla.html)

LEMO products and services are provided "as is". LEMO makes no warranties or representations with regard to LEMO product & services or use of them, express, implied or statutory, including for accuracy, completeness, or security. The user is fully responsible for his products and applications using LEMO components.







# Recommended By Lemo

## Tools

Spanner

[DCA.91.161.1TN](#)

## Cables

Cable PartNumber	Material	Colour	Cable image
CMN.07.T28.044PGZE		grey	
CMN.07.T28.044PNZE			
7041	PVC	Grey	
7050	PVC	Black	
717920	PVC	Grey	
CTR.75.030.121875G	PVC	Grey	

[https://www.lemo.com/int\\_en/solutions/originals/b-indoor-keyed/fag-0b-307-cla.html](https://www.lemo.com/int_en/solutions/originals/b-indoor-keyed/fag-0b-307-cla.html)

LEMO products and services are provided "as is". LEMO makes no warranties or representations with regard to LEMO product & services or use of them, express, implied or statutory, including for accuracy, completeness, or security. The user is fully responsible for his products and applications using LEMO components.