



*Image for illustrative purpose only*

## Summary

[Request a quote](#)

[Catalog](#)

Number of contacts Low Voltage	3
Gender	Standard
Socket / Receptacle	Socket / Receptacle - Fixed Panel Rear Mounted
Locking system	Push-pull
Size	0B
Suggested matching part	<a href="#">FGG.0B.303.CLAD52</a>
Series	B - Indoor keyed

[https://www.lemo.com/int\\_en/solutions/originals/b-indoor-keyed/ecg-0b-303-cln.html](https://www.lemo.com/int_en/solutions/originals/b-indoor-keyed/ecg-0b-303-cln.html)

LEMO products and services are provided "as is". LEMO makes no warranties or representations with regard to LEMO product & services or use of them, express, implied or statutory, including for accuracy, completeness, or security. The user is fully responsible for his products and applications using LEMO components.

# Technical details

## Electrical Configuration

Contact Termination Low voltage	PCB - Straight
R (max)	4.8 mOhm
Insert configuration value	0B.303 - 3 Low Voltage
Insulator	L: PEEK (UL 94 / V-0/1.5)
Rated current	8 A
Vtest (contact-contact)	1200 V (AC), 1700 V (DC)
Vtest (contact-shell)	900 V (AC), 1270 V (DC)
Contact Type	Print (straight)
Contact Dia.	0.9 mm (0.035in)
Number of contacts Low Voltage	3
Gender	Standard

## Form & Material

Shell style / Model id	EC - Fixed receptacle with two nuts and straight contacts for printed circuit (back panel mounting)
Socket / Receptacle	Fixed Panel Rear Mounted
Housing material	Brass (chrome plated [SAE AMS 2460]) shell and collet nut, nickel plated [SAE AMS QQ N 290] brass latch sleeve and mid pieces
Locking system	Push-pull
Keying	G: 1 key (alpha=0, plug: male contacts, receptacle: female contacts)
Colour	Grey
Weight	5.05 g

[https://www.lemo.com/int\\_en/solutions/originals/b-indoor-keyed/ecg-0b-303-cln.html](https://www.lemo.com/int_en/solutions/originals/b-indoor-keyed/ecg-0b-303-cln.html)

LEMO products and services are provided "as is". LEMO makes no warranties or representations with regard to LEMO product & services or use of them, express, implied or statutory, including for accuracy, completeness, or security. The user is fully responsible for his products and applications using LEMO components.

## Environment

Technical domain	Audio Video, Energy and Industrial, Medical, Semiconductor, Specialties and Other, Test and Measurement, Transportation, Aerospace and UAV
Environmental sealing (IP rating)	IP50
Endurance	5000 mating cycles
Temperature range	-55°C / +250°C
Climatical Category	50/175/21
Humidity (max)	<=95% [at 60 deg C /140 F]
Shielding (min)	75 dB (10 MHz)
Shielding (min)	40 dB (1 GHz)
Shock Resistance	100 g [ 6 ms]
Vibration	15 g [10 Hz - 2000 Hz]
Salt Spray Corrosion	>1000 hr

## Drawings

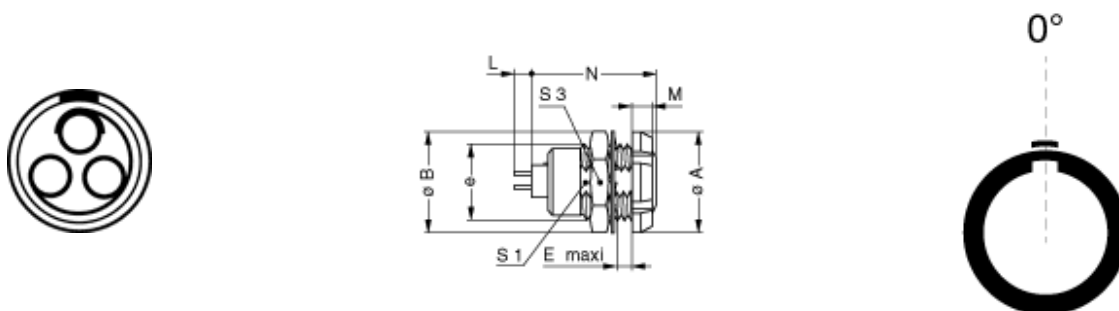

## Dimensions

	<b>A</b>	<b>Nmax</b>	<b>S1</b>	<b>S3</b>	<b>M</b>	<b>B</b>	<b>e</b>	<b>E</b>	<b>Lmax</b>
mm.	12	16.3	8.2	11	2.5	12.4	M9x0.6	5.5	19.55
in.	0.47	0.64	0.32	0.43	0.1	0.49		0.22	0.77

[https://www.lemo.com/int\\_en/solutions/originals/b-indoor-keyed/ecg-0b-303-cln.html](https://www.lemo.com/int_en/solutions/originals/b-indoor-keyed/ecg-0b-303-cln.html)

LEMO products and services are provided "as is". LEMO makes no warranties or representations with regard to LEMO product & services or use of them, express, implied or statutory, including for accuracy, completeness, or security. The user is fully responsible for his products and applications using LEMO components.

# Recommended By Lemo

## Accessories

---

Compatible cap [BRE.0S.200.NAS](#)

## Tools

---

Spanner 2 [DCH.91.121.PA](#)

Spanner wrench [Socket for torque wrench DCM.65.100.AZ and DCM.0S.M09.4](#)

[https://www.lemo.com/int\\_en/solutions/originals/b-indoor-keyed/ecg-0b-303-cln.html](https://www.lemo.com/int_en/solutions/originals/b-indoor-keyed/ecg-0b-303-cln.html)

LEMO products and services are provided "as is". LEMO makes no warranties or representations with regard to LEMO product & services or use of them, express, implied or statutory, including for accuracy, completeness, or security. The user is fully responsible for his products and applications using LEMO components.