



Image for illustrative purpose only

Summary

[Request a quote](#)

[Catalog](#)

Number of contacts Low Voltage	12
Wire Size/AWG	30 - 22
Gender	Standard
Socket / Receptacle	Socket / Receptacle - Fixed Panel Rear Mounted
Locking system	Push-pull
Jacket cable outside diameter [mm]	2.00 - 13.60 mm
Size	2B
Suggested matching part	FGG.2B.312.CLAD82
Series	B - Indoor keyed

https://www.lemo.com/int_en/solutions/originals/b-indoor-keyed/ecg-2b-312-cll.html

LEMO products and services are provided "as is". LEMO makes no warranties or representations with regard to LEMO product & services or use of them, express, implied or statutory, including for accuracy, completeness, or security. The user is fully responsible for his products and applications using LEMO components.

Technical details

Electrical Configuration

Contact Termination Low voltage	Solder
R (max)	6.1 mOhm
Insert configuration value	2B.312 - 12 Low Voltage
Insulator	L: PEEK (UL 94 / V-0/1.5)
Rated current	7 A
Vtest (contact-contact)	1250 V (AC), 1770 V (DC)
Vtest (contact-shell)	1350 V (AC), 1910 V (DC)
Contact Type	Solder
Max. Solid Conductor	0.34 mm ² (AWG 22)
Max. Stranded Conductor	0.34 mm ² (AWG 22)
Bucket Dia.	0.8 mm (0.031in)
Contact Dia.	0.7 mm (0.028in)
Number of contacts Low Voltage	12
Wire Size/AWG	30 - 22
Gender	Standard

Form & Material

Shell style / Model id	EC - Fixed receptacle with two nuts (back panel mounting)
Socket / Receptacle	Fixed Panel Rear Mounted
Housing material	Brass (chrome plated [SAE AMS 2460]) shell and collet nut, nickel plated [SAE AMS QQ N 290] brass latch sleeve and mid pieces
Locking system	Push-pull
Keying	G: 1 key (alpha=0, plug: male contacts, receptacle: female contacts)
Colour	Grey
Weight	16.76 g

https://www.lemo.com/int_en/solutions/originals/b-indoor-keyed/ecg-2b-312-cll.html

LEMO products and services are provided "as is". LEMO makes no warranties or representations with regard to LEMO product & services or use of them, express, implied or statutory, including for accuracy, completeness, or security. The user is fully responsible for his products and applications using LEMO components.

Environment

Technical domain	Audio Video, Energy and Industrial, Medical, Semiconductor, Specialties and Other, Test and Measurement, Transportation, Aerospace and UAV
Environmental sealing (IP rating)	IP50
Endurance	5000 mating cycles
Temperature range	-55°C / +250°C
Climatical Category	50/175/21
Humidity (max)	<=95% [at 60 deg C /140 F]
Shielding (min)	75 dB (10 MHz)
Shielding (min)	40 dB (1 GHz)
Shock Resistance	100 g [6 ms]
Vibration	15 g [10 Hz - 2000 Hz]
Salt Spray Corrosion	>1000 hr

Cable fixation

Jacket cable outside diameter [mm]	2.00 - 13.60 mm
------------------------------------	-----------------

Drawings

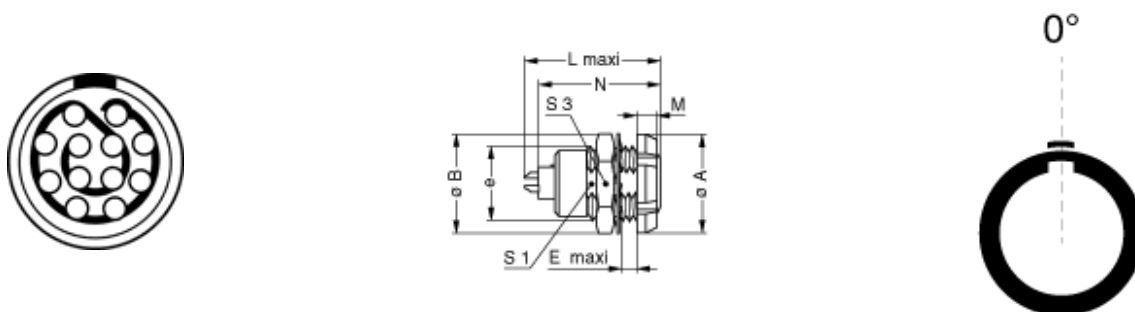

Dimensions

	B	A	L	M	N	S1	S3	E	e
mm.	19.2	20	26.7	3.5	24.6	13.5	17	6.5	M15x1.0
in.	0.76	0.79	1.05	0.14	0.97	0.53	0.67	0.26	

https://www.lemo.com/int_en/solutions/originals/b-indoor-keyed/ecg-2b-312-cll.html

LEMO products and services are provided "as is". LEMO makes no warranties or representations with regard to LEMO product & services or use of them, express, implied or statutory, including for accuracy, completeness, or security. The user is fully responsible for his products and applications using LEMO components.

Recommended By Lemo

Accessories











Compatible cap [BRE.2S.200.NAS](#)

Tools

Spanner 2 [DCH.91.201.PA](#)

Spanner wrench [Socket for torque wrench DCM.65.170.AZ and DCM.2S.M15.6](#)

Cables

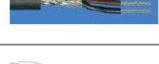
Cable PartNumber	Material	Colour	Cable image
CMN.12.T22.070QGZE	TPR (medical)	Grey	
CMN.12.T28.054PGZE		grey	
CMN.12.T28.054PNZE			
112240	PTFE	White	
112260	PTFE	White	
112280	PVC	Black	
12050	PVC	Black	
124080	PVC	Grey	
124084	PVC	Black	
212220	PVC	Black	
212240	PVC	Black	
212250	PVC	Grey	
212260	PVC	Black	

https://www.lemo.com/int_en/solutions/originals/b-indoor-keyed/ecg-2b-312-cll.html

LEMO products and services are provided "as is". LEMO makes no warranties or representations with regard to LEMO product & services or use of them, express, implied or statutory, including for accuracy, completeness, or security. The user is fully responsible for his products and applications using LEMO components.