



Image for illustrative purpose only

Summary

[Request a quote](#)

[Catalog](#)

Number of contacts Low Voltage	2
Wire Size/AWG	28 - 20
Gender	Standard
Socket / Receptacle	Socket / Receptacle - Fixed Panel Rear Mounted
Locking system	Push-pull
Jacket cable outside diameter [mm]	1.00 - 12.60 mm
Size	0K
Suggested matching part	FGG.0K.302.CLAC20
Series	K - Outdoor keyed

https://www.lemo.com/int_en/solutions/originals/k-outdoor-keyed/heg-0k-302-cllp.html

LEMO products and services are provided "as is". LEMO makes no warranties or representations with regard to LEMO product & services or use of them, express, implied or statutory, including for accuracy, completeness, or security. The user is fully responsible for his products and applications using LEMO components.

Technical details

Electrical Configuration

Contact Termination Low voltage	Solder
R (max)	4.8 mOhm
Insert configuration value	0K.302 - 2 Low Voltage
Insulator	L: PEEK (UL 94 / V-0/1.5)
Rated current	10 A
Vtest (contact-contact)	1300 V (AC), 1840 V (DC)
Vtest (contact-shell)	1050 V (AC), 1490 V (DC)
Contact Type	Solder
Max. Solid Conductor	0.56 mm ² (AWG 20)
Max. Stranded Conductor	0.56 mm ² (AWG 20)
Bucket Dia.	1.0 mm (0.039in)
Contact Dia.	0.9 mm (0.035in)
Number of contacts Low Voltage	2
Wire Size/AWG	28 - 20
Gender	Standard

Form & Material

Shell style / Model id	HE - Fixed receptacle, nut fixing, watertight or vacuum-tight (back panel mounting)
Socket / Receptacle	Fixed Panel Rear Mounted
Housing material	Brass (chrome plated [SAE AMS 2460]) shell, collet nut and latch sleeve, nickel plated [SAE AMS QQ N 290] brass mid pieces
Locking system	Push-pull
Keying	G: 1 key (alpha=0, plug: male contacts, receptacle: female contacts)
Colour	Grey
Variant	Watertight unmated (connector to device)
Weight	12.84 g

https://www.lemo.com/int_en/solutions/originals/k-outdoor-keyed/heg-0k-302-cllp.html

LEMO products and services are provided "as is". LEMO makes no warranties or representations with regard to LEMO product & services or use of them, express, implied or statutory, including for accuracy, completeness, or security. The user is fully responsible for his products and applications using LEMO components.

Environment

Technical domain	Audio Video, Energy and Industrial, Medical, Test and Measurement
Environmental sealing (IP rating)	IP68
Endurance	5000 mating cycles
Temperature range	-20°C / +100°C
Climatical Category	20/80/21
Humidity (max)	<=95% [at 60 deg C /140 F]
Shielding (min)	95 dB (10 MHz)
Shielding (min)	80 dB (1 GHz)
Shock Resistance	100 g [6 ms]
Vibration	15 g [10 Hz - 2000 Hz]
Pressure	60 bars
Salt Spray Corrosion	>1000 hr

Cable fixation

Jacket cable outside diameter [mm]	1.00 - 12.60 mm
------------------------------------	-----------------

Drawings

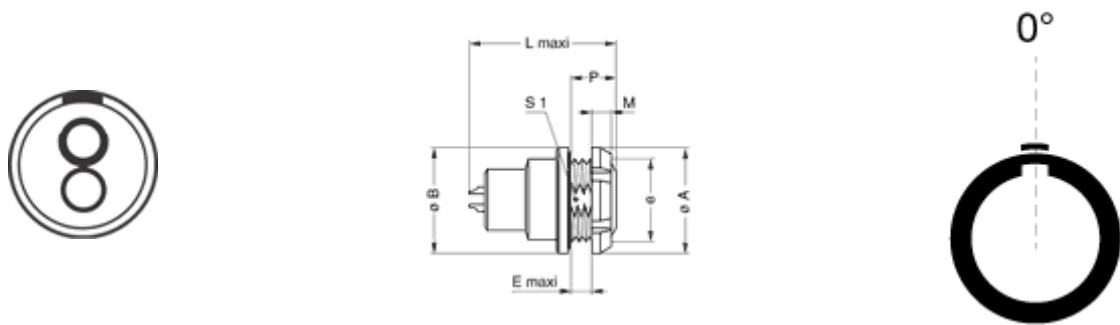

Dimensions

	A	B	L	M	P	S1	e	E
mm.	18	18	22.5	3.5	7	12.5	M14x1.0	2.4
in.	0.71	0.71	0.89	0.14	0.28	0.49		0.09

https://www.lemo.com/int_en/solutions/originals/k-outdoor-keyed/heg-0k-302-cllp.html

LEMO products and services are provided "as is". LEMO makes no warranties or representations with regard to LEMO product & services or use of them, express, implied or statutory, including for accuracy, completeness, or security. The user is fully responsible for his products and applications using LEMO components.

Recommended By Lemo

Accessories

























Compatible cap

[BRE.OK.200.NAS](#)

https://www.lemo.com/int_en/solutions/originals/k-outdoor-keyed/heg-0k-302-cllp.html

LEMO products and services are provided "as is". LEMO makes no warranties or representations with regard to LEMO product & services or use of them, express, implied or statutory, including for accuracy, completeness, or security. The user is fully responsible for his products and applications using LEMO components.

Cables

Cable PartNumber	Material	Colour	Cable image
CMN.02.T28.030PGCE	PVC	GREY	
CMN.02.T28.030PGZE		grey	
CMN.02.T28.030PNCE	PVC	Black	
CMN.02.T28.030PNZE			
102080	PVC	Grey	
120184	PVC	Black	
120240	PVC	Black	
120250	PVC	Grey	
20140	PVC	Grey	
20140	PVC	Grey	
20141	PVC	Grey	
20142	PVC	Red	
20143	PVC	Green	
20144	PVC	Black	
20145	PVC	Yellow	
20146	PVC	Black	
20240	PTFE	White	
20260	PVC	Black	
20264	PVC	Black	
20266	PVC	Violet	
2050	PVC	Black	
20550	PUR	Black	
20560	PUR	White	
2080	PVC	Grey	
2221	PVC	Black	
2260	PTFE	White	
2280	PVC	Black	
4082	PVC	Grey	
CMB.02.210.635	PUR	Black	

https://www.lemo.com/int_en/solutions/originals/k-outdoor-keyed/heg-0k-302-cllp.html

LEMO products and services are provided "as is". LEMO makes no warranties or representations with regard to LEMO product & services or use of them, express, implied or statutory, including for accuracy, completeness, or security. The user is fully responsible for his products and applications using LEMO components.