

HDC14-9 ✓ ACTIVE

DEUTSCH | DEUTSCH HD10, DEUTSCH HD

TE Internal #: HDC14-9

Dust Cap, Gray, PA GF, 9 Position, -55 – 125 °C [-67 – 257 °F],

DEUTSCH HD

[View on TE.com >](#)



Connectors > Automotive Connectors > Automotive Connector Accessories > Automotive Connector Caps & Covers >

DEUTSCH HD10 PLUG DUST CAPS

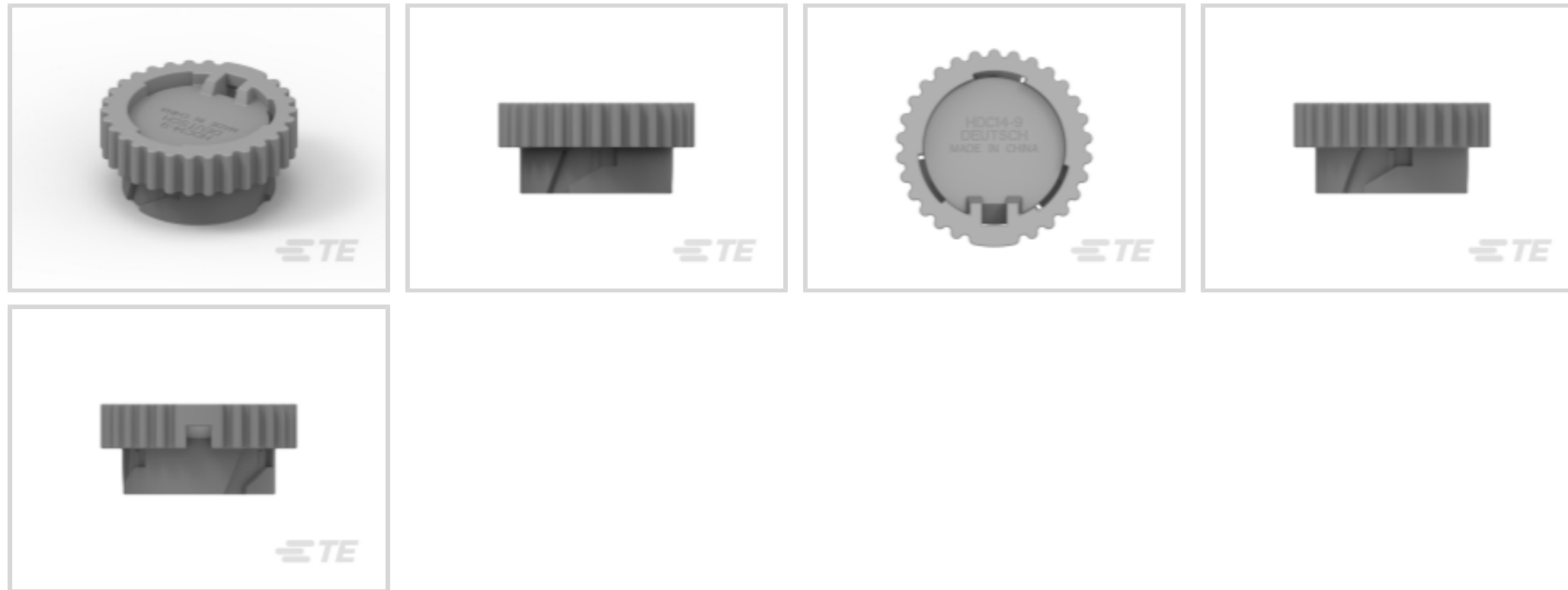

Protection & Strain Relief Accessory Type: **Dust Cap**

Strain Relief: **Without**

Primary Product Color: **Gray**

Primary Product Material: **PA GF**

Number of Positions: **9**

[All DEUTSCH HD10 PLUG DUST CAPS \(6\)](#)

Features

Industry Standards

IP Rating	IP6K9K
UL Flammability Rating	UL 94V-0

Packaging Features

Packaging Method	Box
Packaging Quantity	1

Other

Serviceable	Yes
EU RoHS Compliance	Compliant
EU ELV Compliance	Compliant

Usage Conditions

Compatible With Connector Style	Plug
Operating Temperature (Max)	125 °C[257 °F]



Operating Temperature Range	-55 – 125 °C[-67 – 257 °F]
-----------------------------	----------------------------

Product Type Features

Sealable	Yes
Protection & Strain Relief Accessory Type	Dust Cap

Mechanical Attachment

Strain Relief	Without
---------------	---------

Body Features

Primary Product Color	Gray
Primary Product Material	PA GF

Configuration Features

Number of Positions	9
---------------------	---

Product Compliance

[For compliance documentation, visit the product page on TE.com>](#)

EU RoHS Directive 2011/65/EU	Compliant
EU ELV Directive 2000/53/EC	Compliant
China RoHS 2 Directive MIIT Order No 32, 2016	No Restricted Materials Above Threshold
EU REACH Regulation (EC) No. 1907/2006	Current ECHA Candidate List: JUNE 2024 (241) Candidate List Declared Against: JUNE 2024 (241) Does not contain REACH SVHC
Halogen Content	Not Low Halogen - contains Br or Cl > 900 ppm.
Solder Process Capability	Not reviewed for solder process capability

Product Compliance Disclaimer

This information is provided based on reasonable inquiry of our suppliers and represents our current actual knowledge based on the information they provided. This information is subject to change. The part numbers that TE has identified as EU RoHS compliant have a maximum concentration of 0.1% by weight in homogenous materials for lead, hexavalent chromium, mercury, PBB, PBDE, DBP, BBP, DEHP, DIBP, and 0.01% for cadmium, or qualify for an exemption to these limits as defined in the Annexes of Directive 2011/65/EU (RoHS2). Finished electrical and electronic equipment products will be CE marked as required by Directive 2011/65/EU. Components may not be CE marked. Additionally, the part numbers that TE has identified as EU ELV compliant have a maximum concentration of 0.1% by weight in homogenous materials for lead, hexavalent chromium, and mercury, and 0.01% for cadmium, or qualify for an exemption to these limits as defined in the Annexes of Directive 2000/53/EC (ELV). Regarding the REACH Regulation, the information TE provides on SVHC in articles for this part number is based on the latest European Chemicals Agency (ECHA) 'Guidance on requirements for substances in articles' posted at this URL: <https://echa.europa.eu/guidance-documents/guidance-on-reach>

Compatible Parts



TE Part # CAT-H3910-CH8172
DEUTSCH HD10 Housings

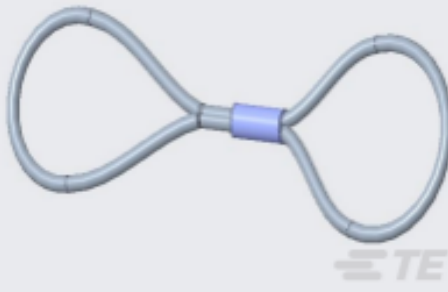

TE Part # JDL082397
RUBBER LANYARD

Also in the Series | DEUTSCH HD



Automotive Headers(1)



Automotive Housings(53)



Connector Backshells(17)



Connector Strain Relief(5)



Insertion & Extraction Tools(11)



Other Automotive Connector Accessories(12)

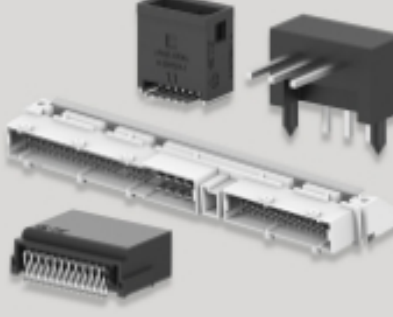

PCB Headers & Receptacles(1)



Wire-to-Board Headers & Receptacles (1)

Also in the Series | DEUTSCH HD10



Automotive Connector Caps & Covers (17)



Automotive Headers(1)



Automotive Housings(53)



Wire-to-Board Headers & Receptacles (1)

Customers Also Bought

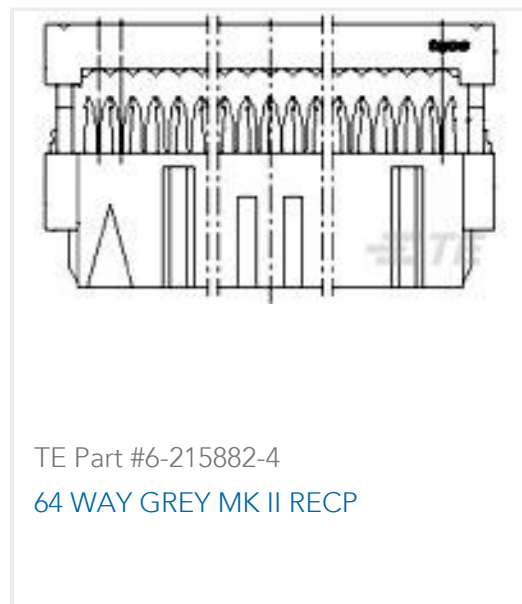

Documents

Product Drawings

[DUST CAP, 9P, PLG, GRY, HD10](#)

English

CAD Files

[3D PDF](#)

3D

Customer View Model

[ENG_CVM_CVM_HDC14-9_99_c-hdc14-9-99.2d_dxf.zip](#)

English

Customer View Model

[ENG_CVM_CVM_HDC14-9_99_c-hdc14-9-99.3d_igs.zip](#)

English

Customer View Model

[ENG_CVM_CVM_HDC14-9_99_c-hdc14-9-99.3d_stp.zip](#)

English

By downloading the CAD file I accept and agree to the [Terms and Conditions](#) of use.

Datasheets & Catalog Pages

[DEUTSCH HD10 CONNECTOR SERIES](#)

English

[ICT Terminals and Connectors Catalogue](#)

English

[CONNECTOR SELECTOR](#)

English

Product Specifications



Engineering Report

English