

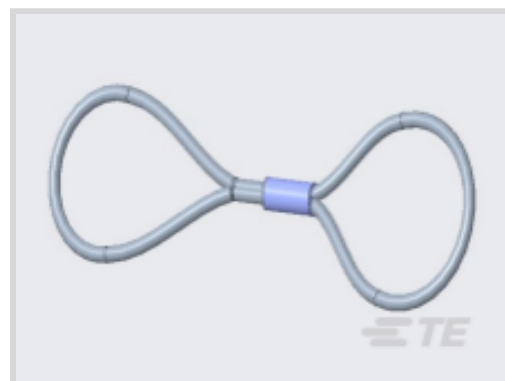

Connectors > Automotive Connectors > Automotive Connector Accessories > Other Automotive Connector Accessories



Automotive Connector Accessory Type: **Cap**

Primary Product Material: **Rubber**

Primary Product Color: **Black**

Operating Temperature Range: **-40 – 108 °C [-40 – 226 °F]**

EU RoHS Compliance: **Compliant**

## Features

### Product Type Features

Automotive Connector Accessory Type	Cap
-------------------------------------	-----

### Body Features

Primary Product Material	Rubber
Primary Product Color	Black

### Usage Conditions

Operating Temperature Range	-40 – 108 °C[-40 – 226 °F]
-----------------------------	----------------------------

### Other

EU RoHS Compliance	Compliant
EU ELV Compliance	Compliant

## Product Compliance

[For compliance documentation, visit the product page on TE.com>](#)

EU RoHS Directive 2011/65/EU	Compliant
EU ELV Directive 2000/53/EC	Compliant
China RoHS 2 Directive MIIT Order No 32, 2016	No Restricted Materials Above Threshold
EU REACH Regulation (EC) No. 1907/2006	Current ECHA Candidate List: JUNE 2024 (241) Candidate List Declared Against: JAN 2023 (233) Does not contain REACH SVHC

Halogen Content	Low Halogen - Br, Cl, F, I < 900 ppm per homogenous material. Also BFR/CFR/PVC Free
Solder Process Capability	Not applicable for solder process capability

Product Compliance Disclaimer

This information is provided based on reasonable inquiry of our suppliers and represents our current actual knowledge based on the information they provided. This information is subject to change. The part numbers that TE has identified as EU RoHS compliant have a maximum concentration of 0.1% by weight in homogenous materials for lead, hexavalent chromium, mercury, PBB, PBDE, DBP, BBP, DEHP, DIBP, and 0.01% for cadmium, or qualify for an exemption to these limits as defined in the Annexes of Directive 2011/65/EU (RoHS2). Finished electrical and electronic equipment products will be CE marked as required by Directive 2011/65/EU. Components may not be CE marked. Additionally, the part numbers that TE has identified as EU ELV compliant have a maximum concentration of 0.1% by weight in homogenous materials for lead, hexavalent chromium, and mercury, and 0.01% for cadmium, or qualify for an exemption to these limits as defined in the Annexes of Directive 2000/53/EC (ELV). Regarding the REACH Regulation, the information TE provides on SVHC in articles for this part number is based on the latest European Chemicals Agency (ECHA) 'Guidance on requirements for substances in articles' posted at this URL: <https://echa.europa.eu/guidance-documents/guidance-on-reach>

### Compatible Parts



TE Part # CAT-H396-RC8382  
Receptacle Protective Caps — DEUTSCH HDP20



TE Part # CAT-H3910-RC1748  
Receptacle Dust Caps — DEUTSCH HD10



TE Part # CAT-H3910-PC1748  
DEUTSCH HD10 PLUG DUST CAPS

### Also in the Series | DEUTSCH HD



Automotive Headers(1)

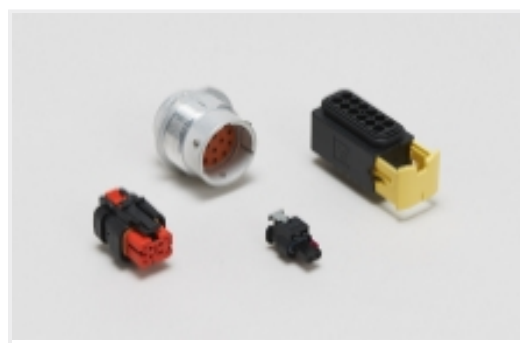

Automotive Housings(357)



Connector Backshells(10)



Connector Strain Relief(5)



Insertion & Extraction Tools(11)

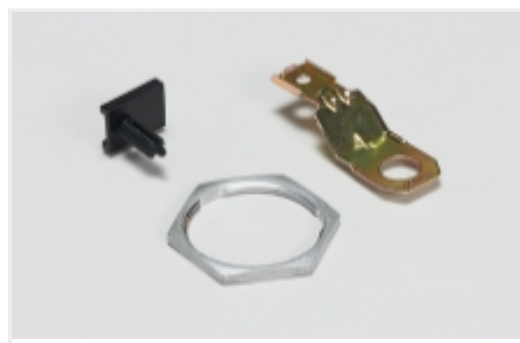

Other Automotive Connector Accessories(6)



PCB Headers & Receptacles(1)

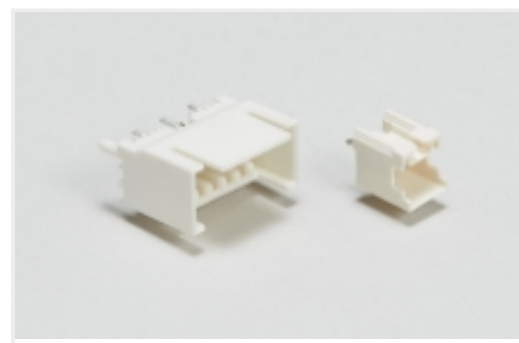

Wire-to-Board Headers & Receptacles (1)

## Also in the Series | DEUTSCH HDP

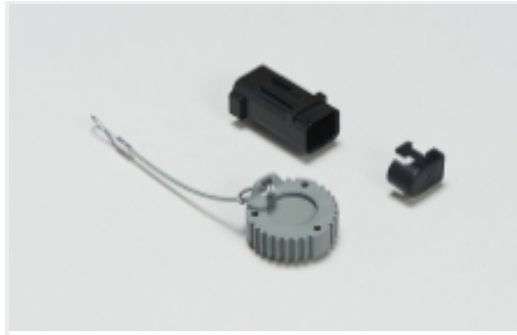

Automotive Connector Caps & Covers (4)

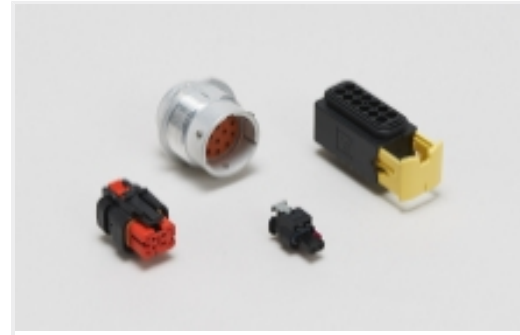

Automotive Housings(357)



Connector Backshells(10)



Connector Seals & Cavity Plugs(1)



Insertion & Extraction Tools(11)

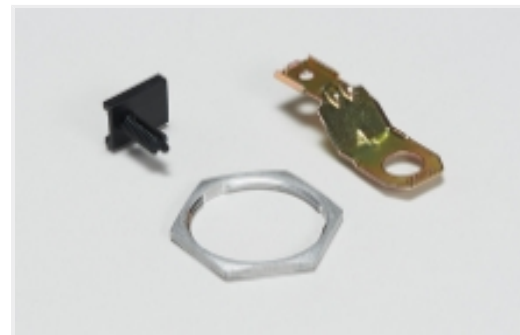

Other Automotive Connector Accessories(6)

## Customers Also Bought



TE Part #5-1437622-5  
KN501BA1/8=KNOB BLK/ALUM 1/8 I



TE Part #CAT-H396-CH8172  
DEUTSCH HDP20 Housings



TE Part #CAT-D487-B128  
DEUTSCH DT Backshells



TE Part #CAT-H3910-CH8172  
DEUTSCH HD10 Housings

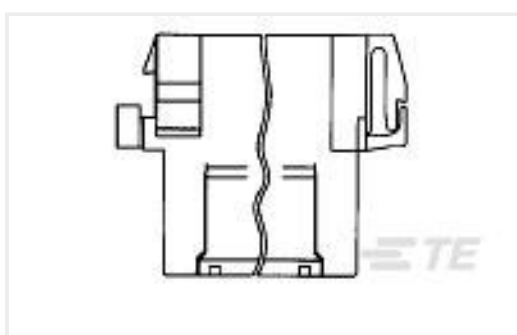

TE Part #929505-7  
FF FA-STE-GEH2X11P



TE Part #1437597-1  
2SKF131AEL01=NON UL 110VAC



TE Part #1-1904045-2  
V23333Z1001A008-EV-100

## Documents

[Product Drawings](#)  
[RUBBER LANYARD](#)

English

[CAD Files](#)  
[3D PDF](#)  
3D



**Customer View Model**

[ENG\\_CVM\\_CVM\\_JDL082397\\_99.2d\\_dxf.zip](#)

English

**Customer View Model**

[ENG\\_CVM\\_CVM\\_JDL082397\\_99.3d\\_igs.zip](#)

English

**Customer View Model**

[ENG\\_CVM\\_CVM\\_JDL082397\\_99.3d\\_stp.zip](#)

English

By downloading the CAD file I accept and agree to the [Terms and Conditions](#) of use.

---

**Datasheets & Catalog Pages**

[DEUTSCH HD10 CONNECTOR SERIES](#)

English

[CONNECTOR SELECTOR](#)

English

---

**Product Specifications**

[Application Specification](#)

English