



Connectors > Connector Accessories > Connector Backshells > DEUTSCH HD10 Backshells



Connector Backshell Product Type: **Backshell**

Primary Product Material: **PBT**

Sealable: **No**

Operating Temperature Range: **-40 – 134 °C [-40 – 273 °F]**

EU RoHS Compliance: **Compliant**

[All DEUTSCH HD10 Backshells \(17\)](#)

Features

Industry Standards

IP Rating	IP6K9K
UL Flammability Rating	UL 94V-0

Packaging Features

Packaging Method	Box
------------------	-----

Dimensions

Compatible Cable Diameter Range	0 – 14.48 mm[0 – .57 in]
---------------------------------	--------------------------

Other

Serviceable	Yes
EU RoHS Compliance	Compliant
EU ELV Compliance	Compliant

Usage Conditions

Operating Temperature (Max)	134 °C[273 °F]
Operating Temperature Range	-40 – 134 °C[-40 – 273 °F]

Body Features

Cable Exit Angle	180°
Primary Product Color	Black
Primary Product Material	PBT

Product Type Features

Connector Backshell Product Type	Backshell
Sealable	No

Product Compliance

[For compliance documentation, visit the product page on TE.com>](#)

EU RoHS Directive 2011/65/EU	Compliant
EU ELV Directive 2000/53/EC	Compliant
China RoHS 2 Directive MIIT Order No 32, 2016	No Restricted Materials Above Threshold
EU REACH Regulation (EC) No. 1907/2006	Current ECHA Candidate List: JUNE 2024 (241) Candidate List Declared Against: JUNE 2023 (235) Does not contain REACH SVHC
Halogen Content	Not Low Halogen - contains Br or Cl > 900 ppm.
Solder Process Capability	Not reviewed for solder process capability

Product Compliance Disclaimer

This information is provided based on reasonable inquiry of our suppliers and represents our current actual knowledge based on the information they provided. This information is subject to change. The part numbers that TE has identified as EU RoHS compliant have a maximum concentration of 0.1% by weight in homogenous materials for lead, hexavalent chromium, mercury, PBB, PBDE, DBP, BBP, DEHP, DIBP, and 0.01% for cadmium, or qualify for an exemption to these limits as defined in the Annexes of Directive 2011/65/EU (RoHS2). Finished electrical and electronic equipment products will be CE marked as required by Directive 2011/65/EU. Components may not be CE marked. Additionally, the part numbers that TE has identified as EU ELV compliant have a maximum concentration of 0.1% by weight in homogenous materials for lead, hexavalent chromium, and mercury, and 0.01% for cadmium, or qualify for an exemption to these limits as defined in the Annexes of Directive 2000/53/EC (ELV). Regarding the REACH Regulation, the information TE provides on SVHC in articles for this part number is based on the latest European Chemicals Agency (ECHA) 'Guidance on requirements for substances in articles' posted at this URL: <https://echa.europa.eu/guidance-documents/guidance-on-reach>

Compatible Parts



Also in the Series | DEUTSCH HD

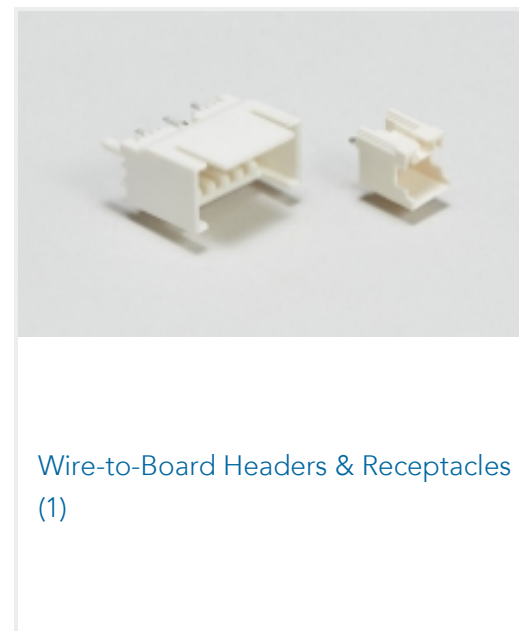
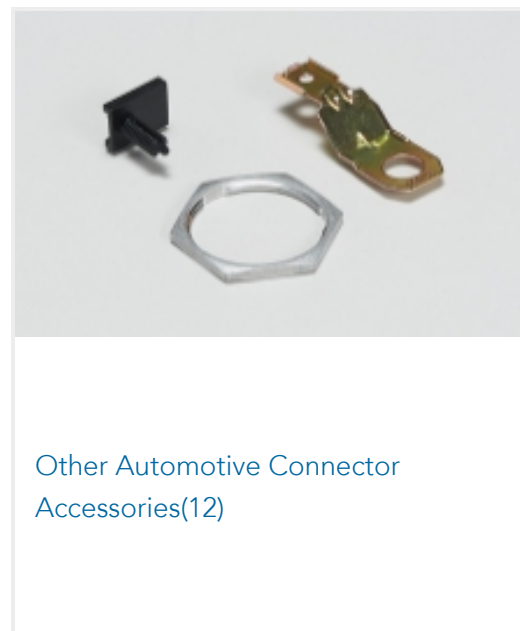
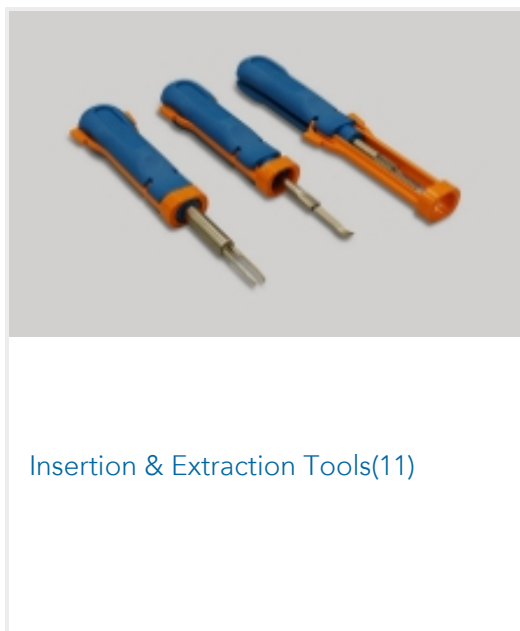
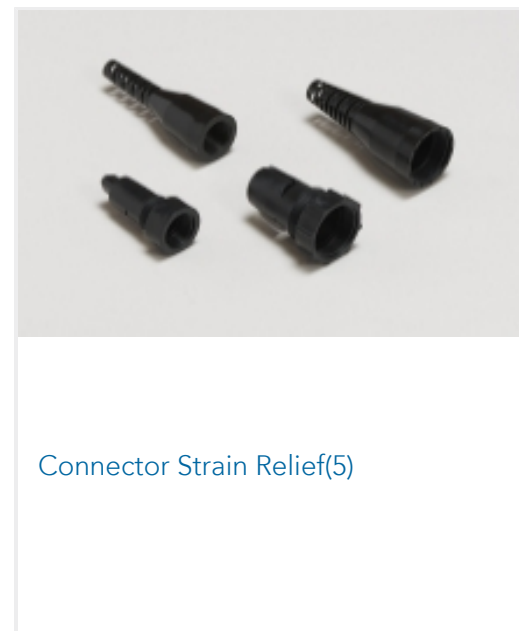
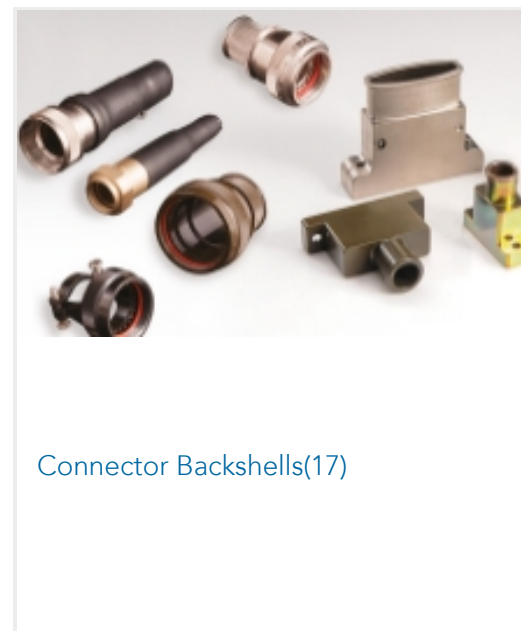
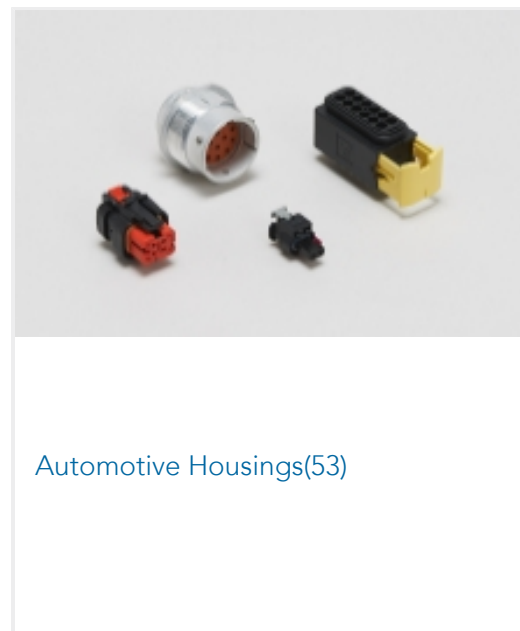
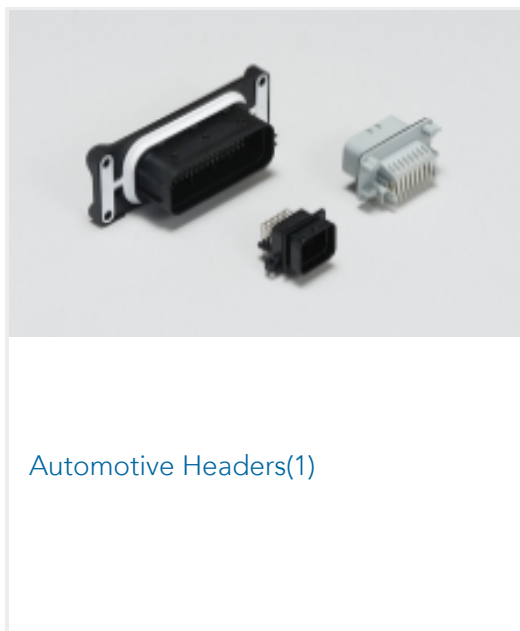

Also in the Series | DEUTSCH HD10

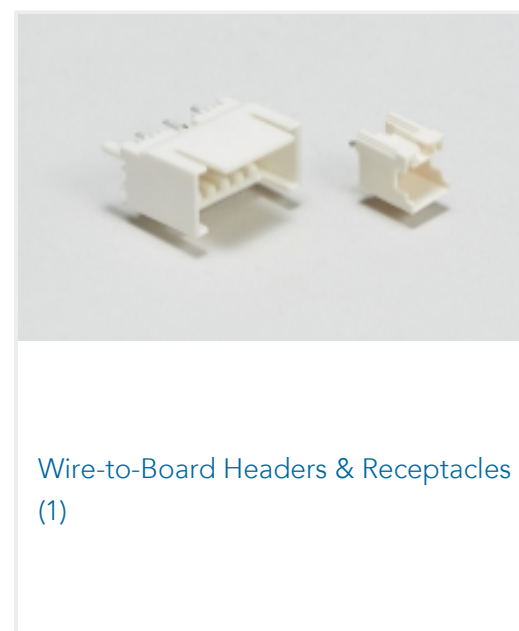
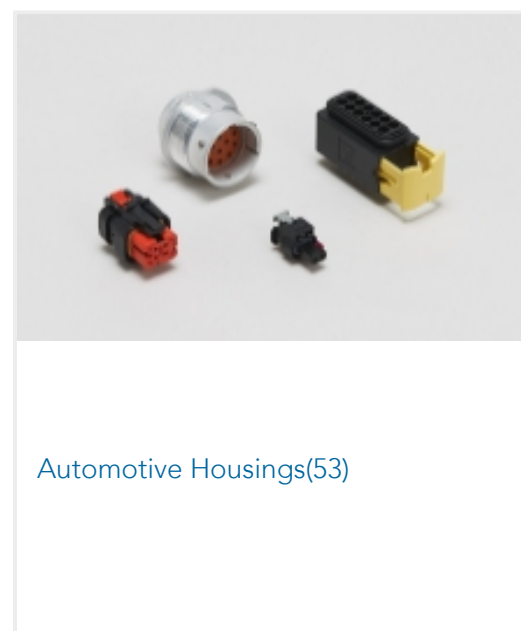
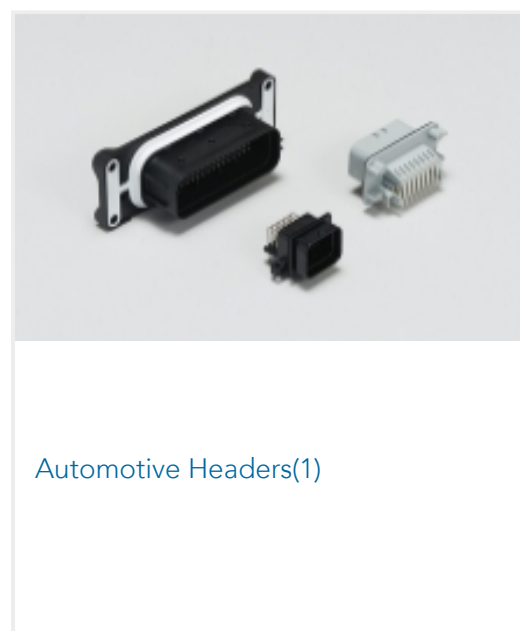
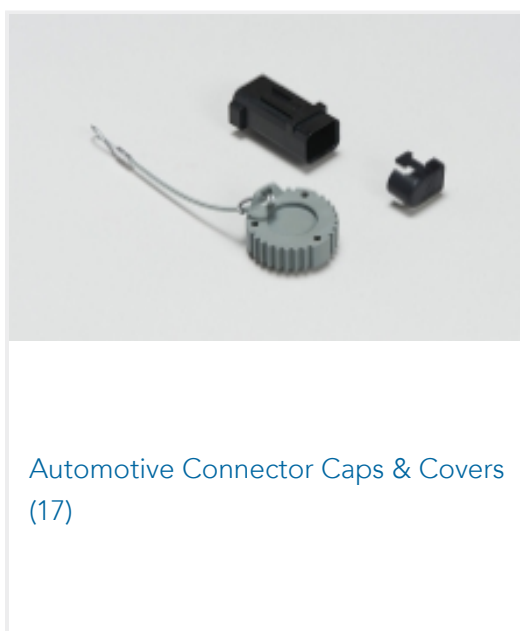

Customers Also Bought



TE Part #3-1534903-5
60POS MIXED MQS REC SEALED
COD 2-3-6-7

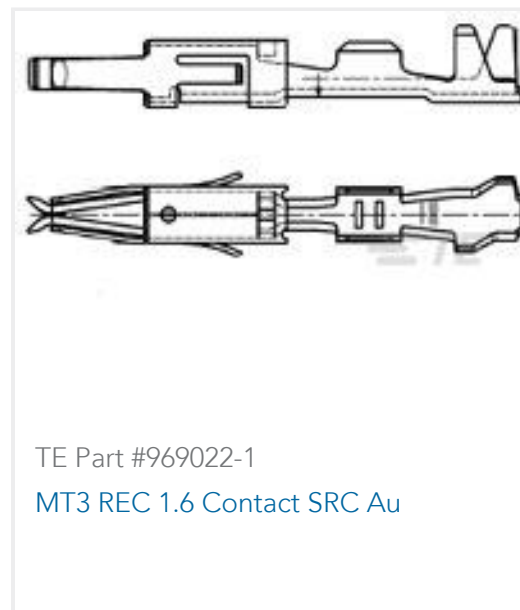

TE Part #969022-1
MT3 REC 1.6 Contact SRC Au



TE Part #936662-2
COVER HSG FOR SHIELD 60P



TE Part #0528-007-6005
BKSHL, 60P, BLK, PLG, RA, SIDE, NW
26



TE Part #9-1452380-9
96 POS. CONNECTOR ASSY



TE Part #K1160994
Plunger Switch 44-01-037-900



TE Part #CAT-M8793-T273
MQS, RECEPTACLE AND TAB



TE Part #9-1452415-9
58POS CONNECTOR ASSY F.
CONNECTOR154POS



TE Part #936661-2
LEVER HSG FOR SHIELD 94P(B)

Documents

Product Drawings

[BKSHL, 9SZ, CBL SZ .430-.570, HD10](#)

English

CAD Files

[3D PDF](#)

3D

Customer View Model

[ENG_CVM_CVM_M902-2193_A.2d_dxf.zip](#)

English

Customer View Model

[ENG_CVM_CVM_M902-2193_A.3d_igs.zip](#)

English

Customer View Model

[ENG_CVM_CVM_M902-2193_A.3d_stp.zip](#)

English

By downloading the CAD file I accept and agree to the [Terms and Conditions](#) of use.

Datasheets & Catalog Pages



[DEUTSCH HD10 CONNECTOR SERIES](#)

English

[ICT Terminals and Connectors Catalogue](#)

English

[CONNECTOR SELECTOR](#)

English

[Product Specifications](#)

[Application Specification](#)

English