

# NOVASTACK® 35-HDP

High-speed (20+ Gbps/lane) fully-shielded with power contacts, 0.35 mm pitch, 0.7 mm height

## Product Specifications:

Board Pitch (mm)	0.35	
Wiping Length (mm)	Signal contact : 0.11, Power contact : 0.13	
Mated Size (mm)	Height	0.7 +/- 0.05
	Width	Formula: $4.89 + (0.35 * p/2)$
	Depth	3.7
Current Rating	Signal	0.3 A/pin
	Power	2.2 A/pin x 4
Pin Counts	Range	6 - 76 (signal) + 4 (power)
	Available	16, 28, 34, 42, 56, 62 /+ 4

\* Please inquire for pin counts not listed or outside of the pin count range.

## Applicable Standards (Reference Only):

USB4 (20 Gbps/lane) USB 3.1 Gen 2 (10 Gbps)  
eDP HBR 3 (8.1 Gbps) eDP HBR 2 (5.4 Gbps)  
HDMI 2.0 (6 Gbps) V-By-One HS 1.4 (4 Gbps)  
MiPi standards

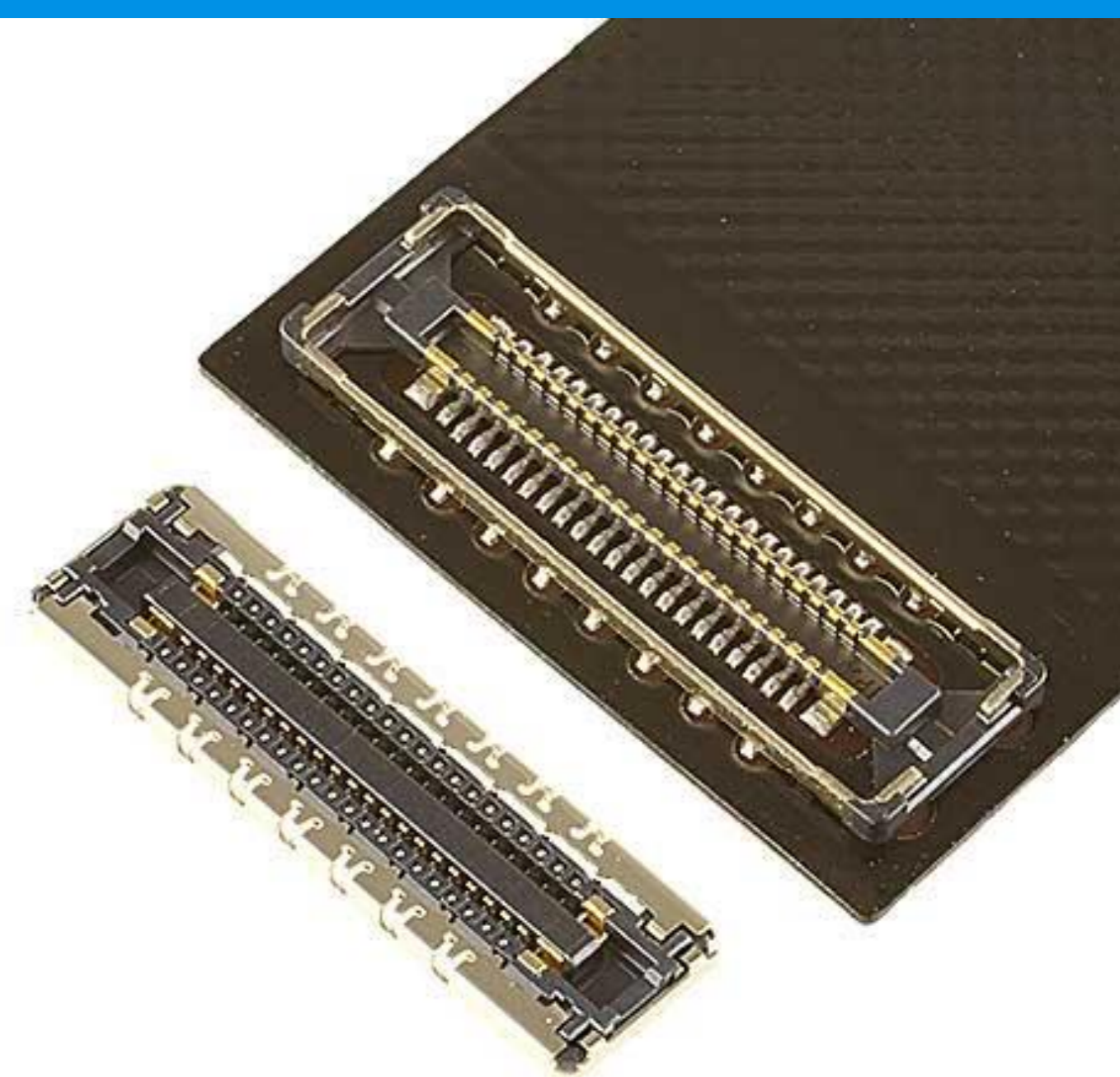

## ▶ ZenShield® fully-shielded with multi-point grounds to prevent EMI leakage

### ○ Ground SMT points

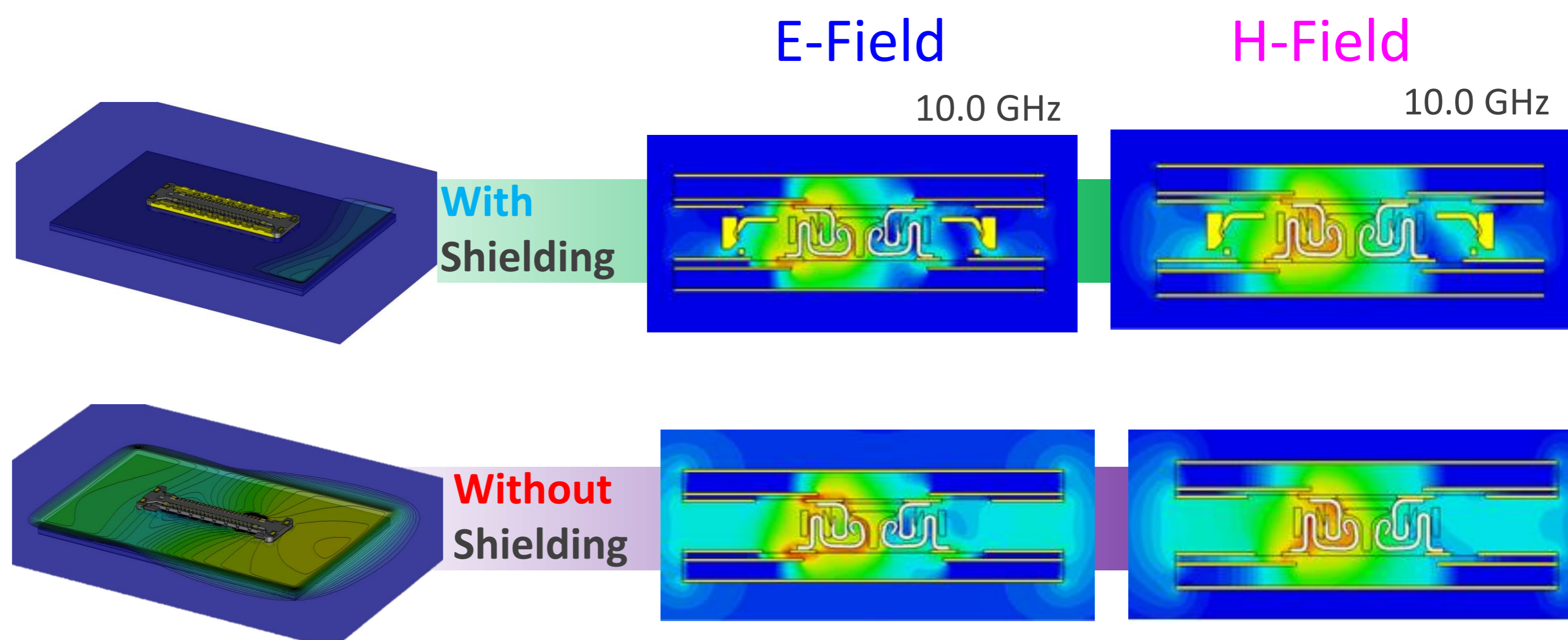
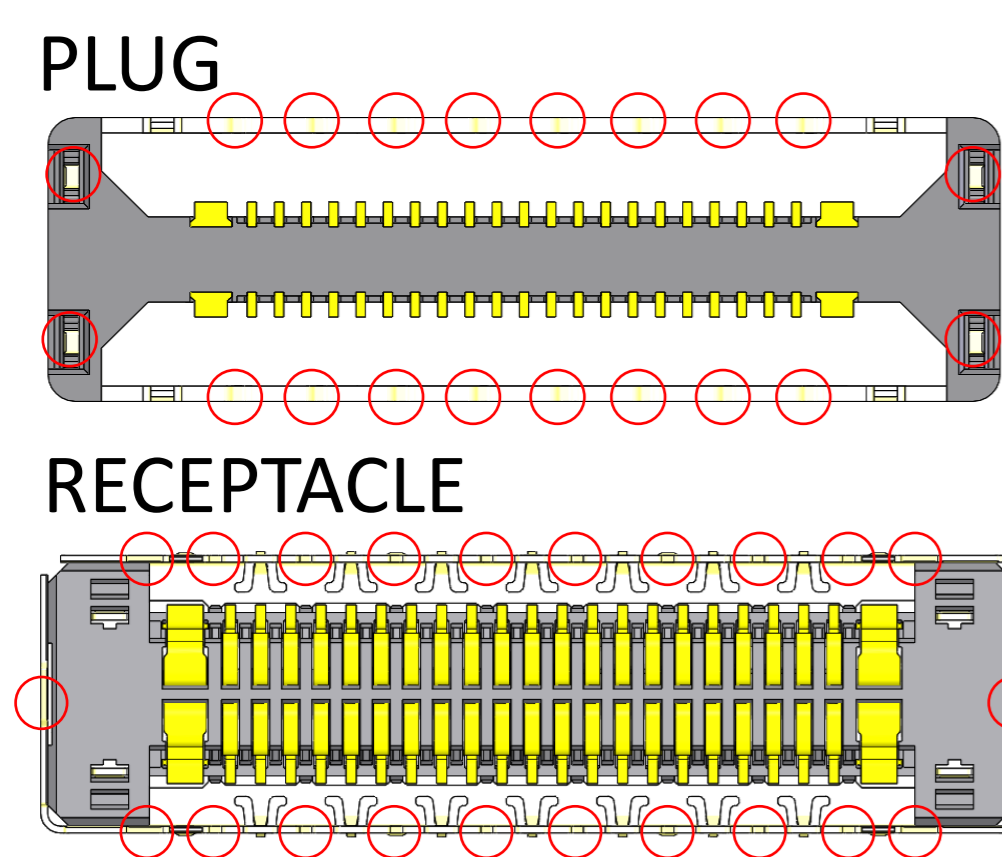

## ▶ Ideal for high-speed transmission e.g. USB4 / Thunderbolt 4 (20+ Gbps / lane)

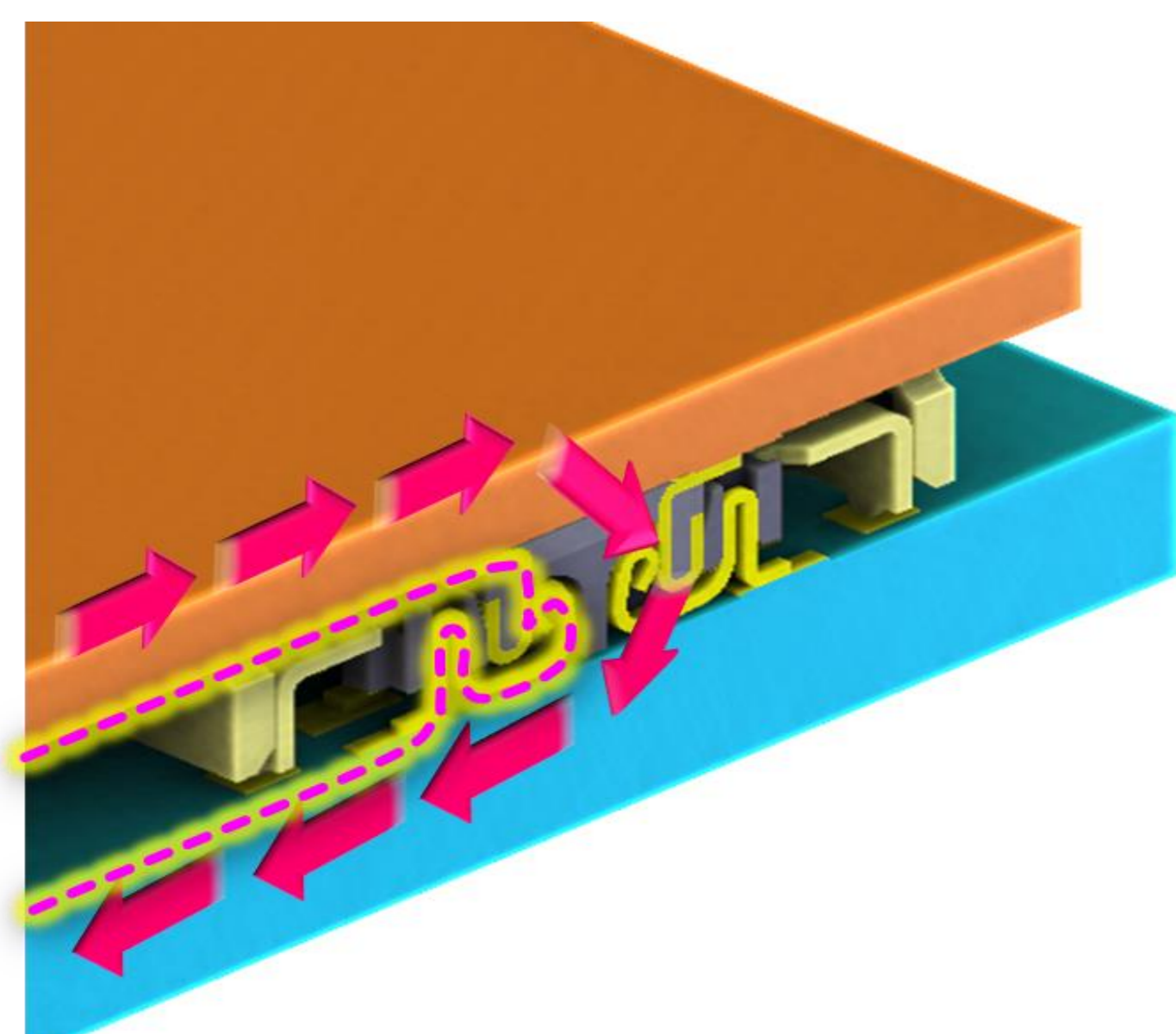

\*Please contact I-PEX for more test details.

### Eye pattern

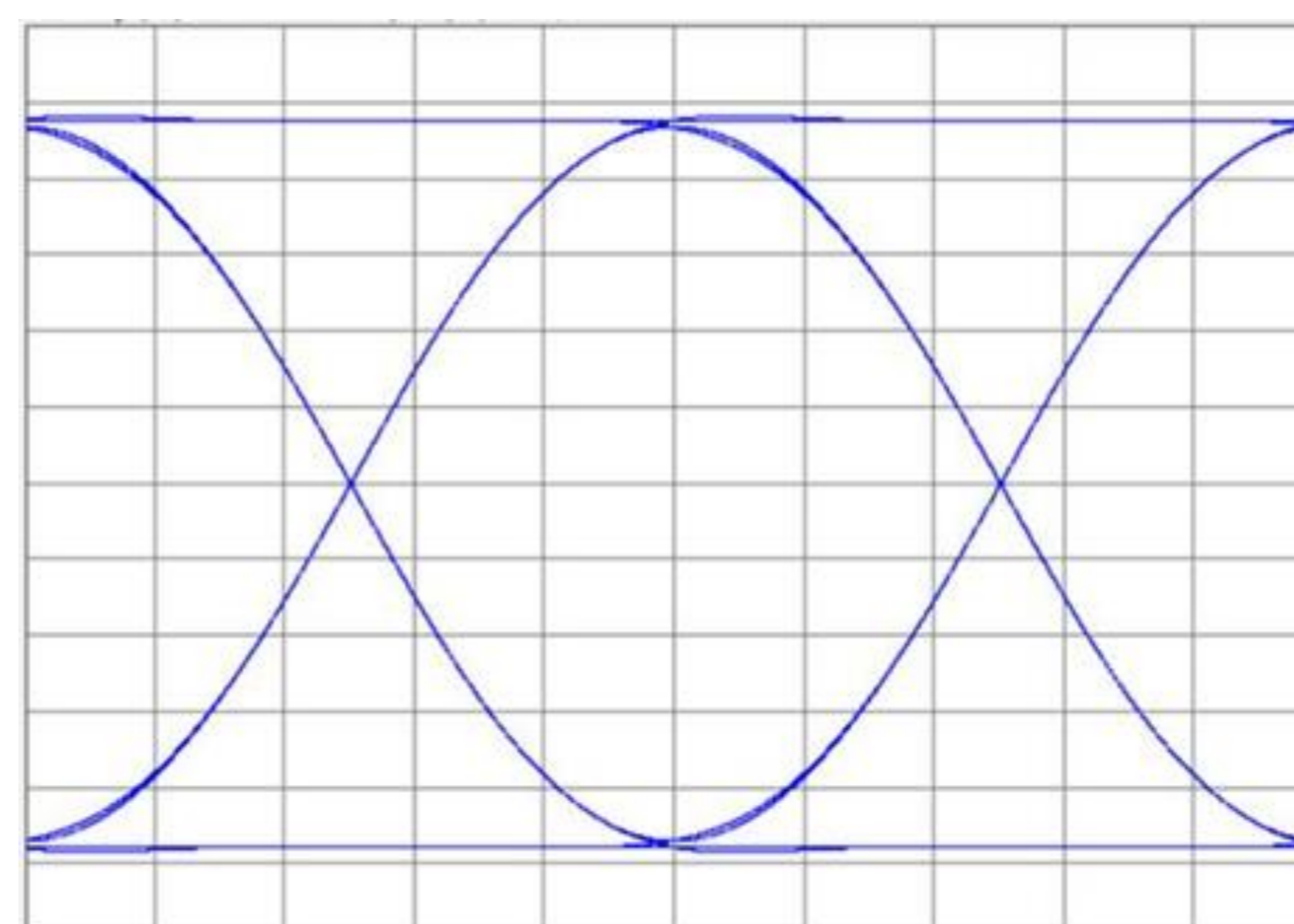

Bit rate : 25 Gbps  
Rise time : 20 ps (10-90%)  
Input voltage : 800 mVp-p

## ▶ 2.2 A power pin x 4 for power delivery

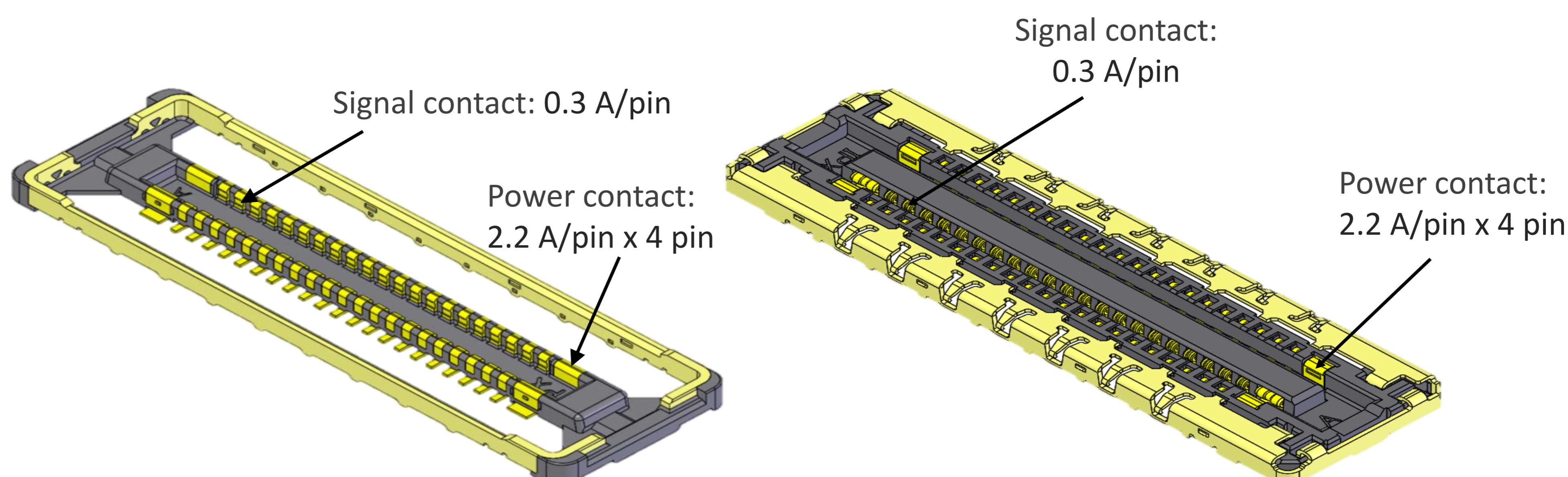

# Component Parts Detail

## Plug Assembly

Recommended P/N		20697-0**E-01#-#					
PART No.	SIGNAL POS.	POWER POS.	A	B	C	D	E
20697-016E-01-P	16P	4P	7.69	5.89	3.50	2.45	7.09
20697-028E-01	28P	4P	9.79	7.99	5.60	4.55	9.19
20697-034E-01	34P	4P	10.84	9.04	6.65	5.60	10.24
20697-042E-01#	42P	4P	12.24	10.44	8.05	7.00	11.64
20697-056E-01#	56P	4P	14.69	12.89	10.50	9.45	14.09
20697-062E-01#	62P	4P	15.74	13.94	11.55	10.50	15.14

20697-0\*\*E-01M-P  
 HOUSING MATERIAL  
 WITHOUT : LCP, UL94-0, BLACK  
 WITH : LCP, UL94-0, BLACK (PFAS FREE)  
 WITHOUT : 10,000 pcs/REEL  
 WITH : 5,000 pcs/REEL  
 Pos.

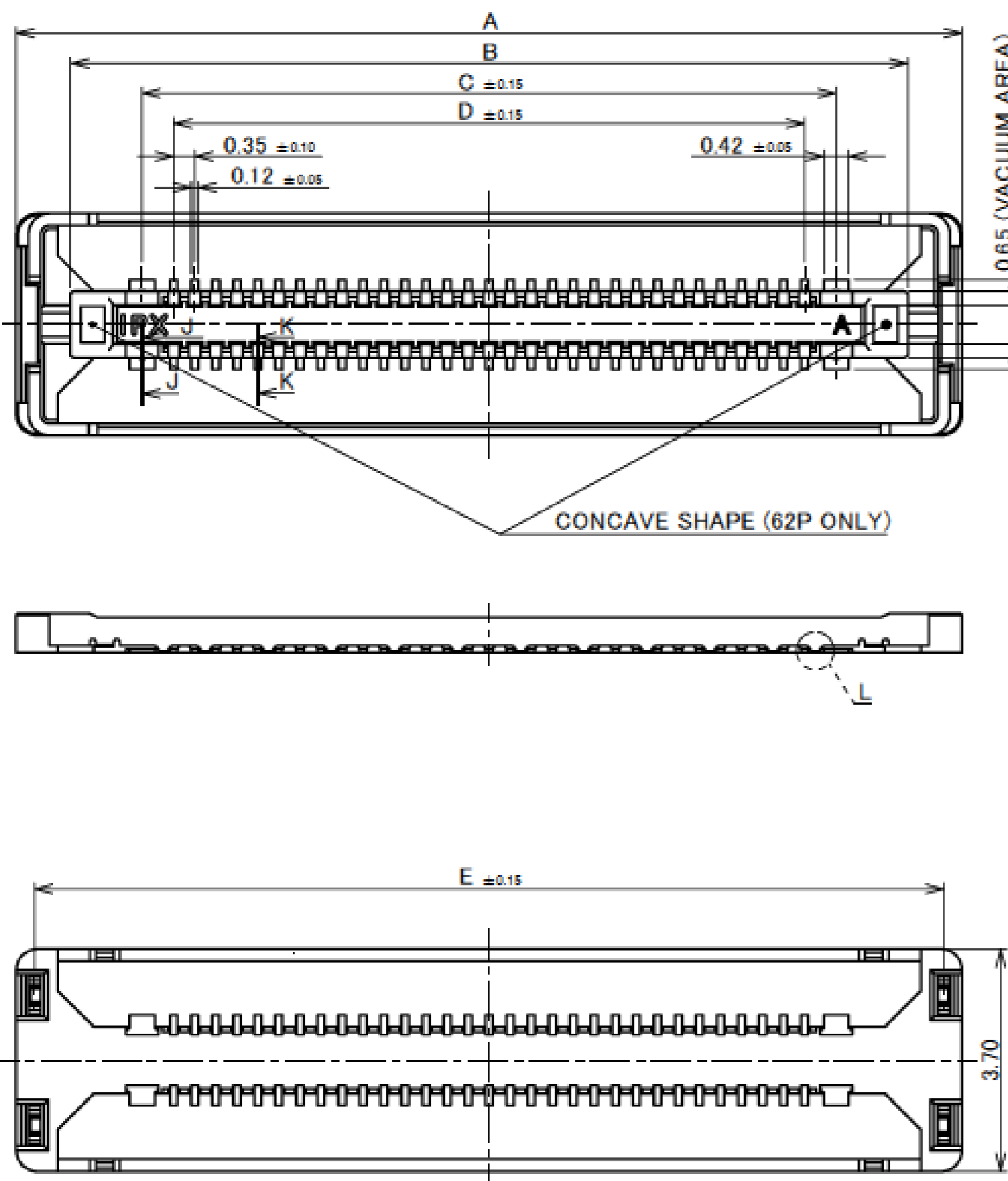

NO.	DISCRIPTION	MATERIAL	FINISH , REMARKS
4	SHELL	PHOSPHOR BRONZE	ALL OVER Ni 1.27 μm MIN. Au 0.01 μm MIN.
3	POWER CONTACT	CORSON ALLOY	ALL OVER Ni 1.27 μm MIN. CONTACT PART Au 0.05 μm MIN. SOLDERING PART Au 0.02 μm MIN.
2	SIGNAL CONTACT	CORSON ALLOY	ALL OVER Ni 1.27 μm MIN. CONTACT PART Au 0.05 μm MIN. SOLDERING PART Au 0.02 μm MIN.
1	HOUSING	LCP	UL94V-0, BLACK

# Plug Assembly

PART No.	SIGNAL POS.	POWER POS.
20697-016E-01-P	16P	4P
20697-028E-01	28P	4P
20697-034E-01	34P	4P
20697-042E-01#	42P	4P
20697-056E-01#	56P	4P
20697-062E-01#	62P	4P

20697-0\*\*E-01M-P

HOUSING MATERIAL  
 WITHOUT : LCP, UL94-0, BLACK  
 WITH : LCP, UL94-0, BLACK (PFAS FREE)

WITHOUT : 10,000 pcs/REEL  
 WITH : 5,000 pcs/REEL

Pos.

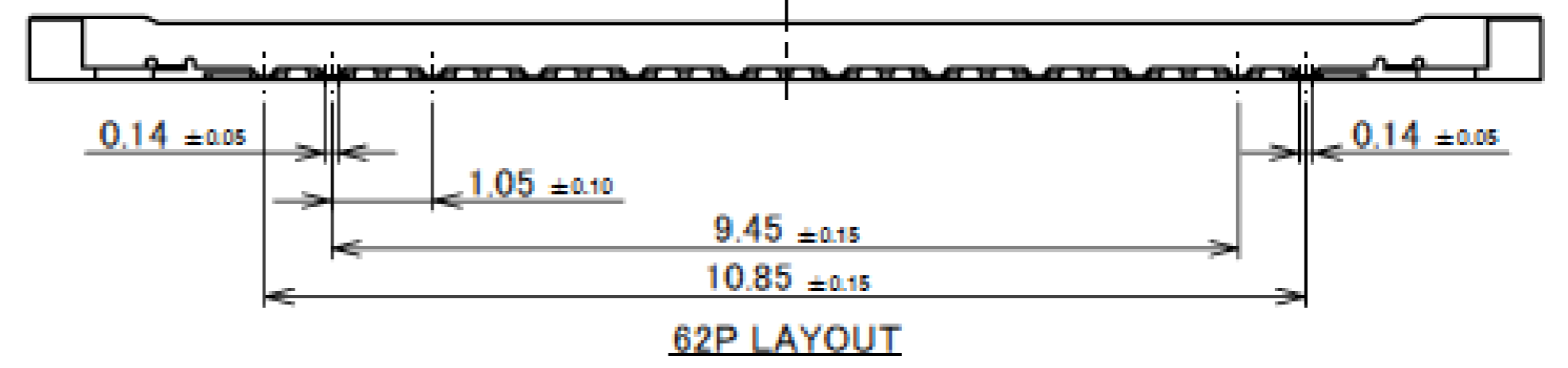
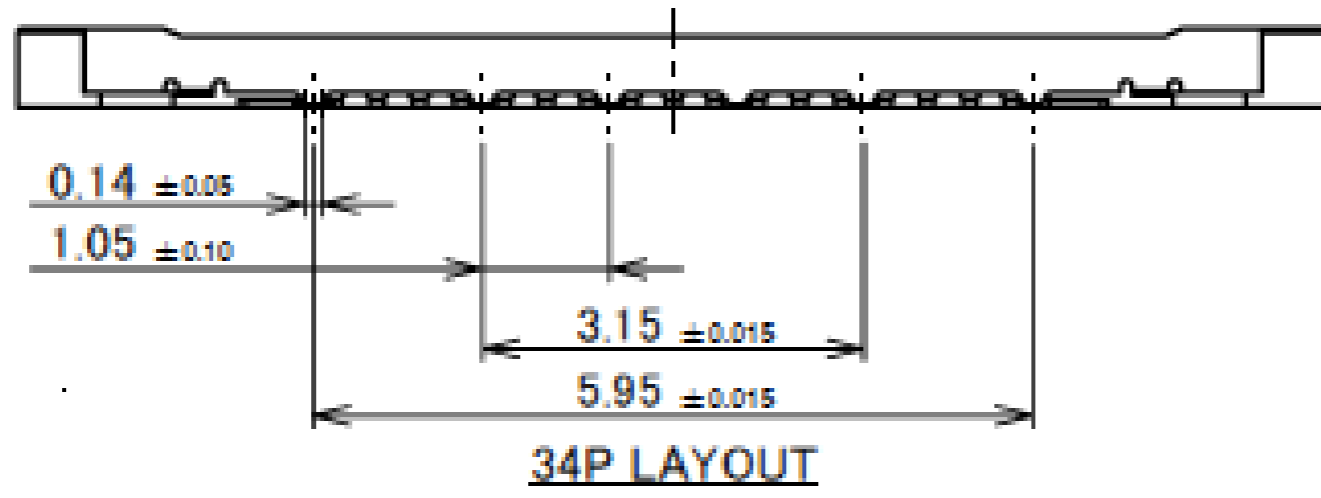
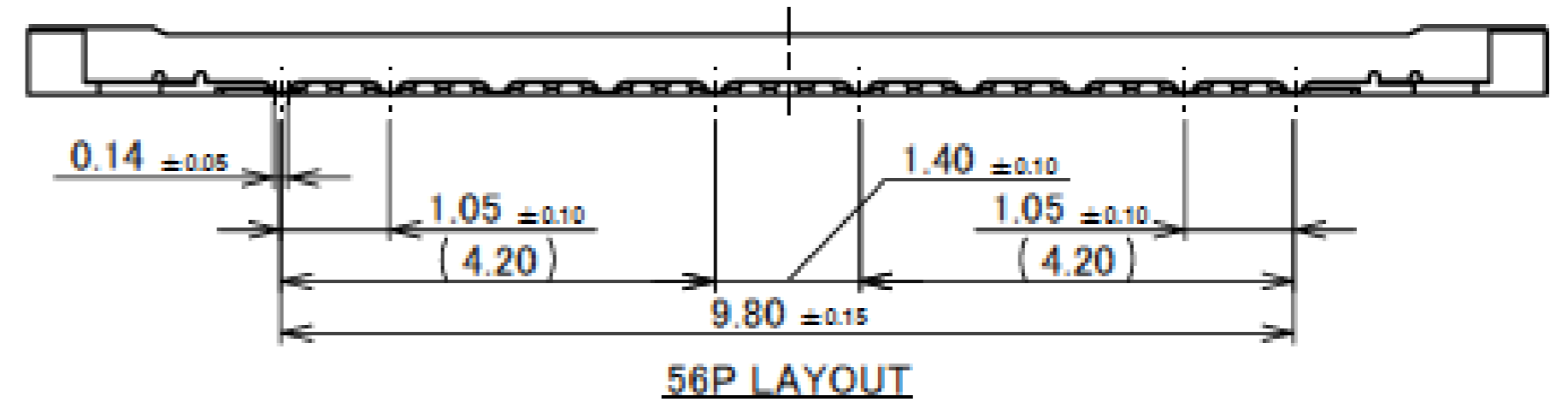
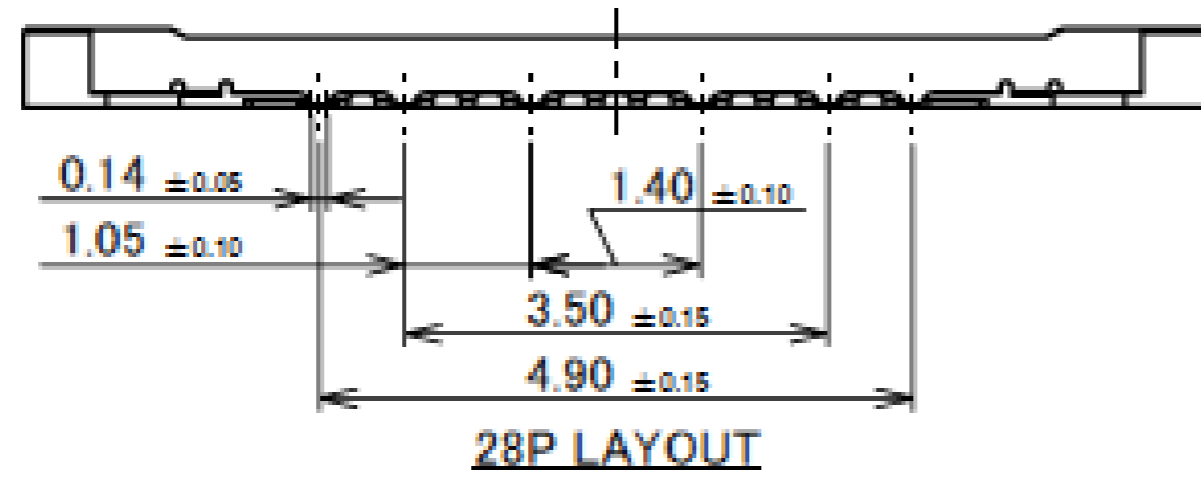
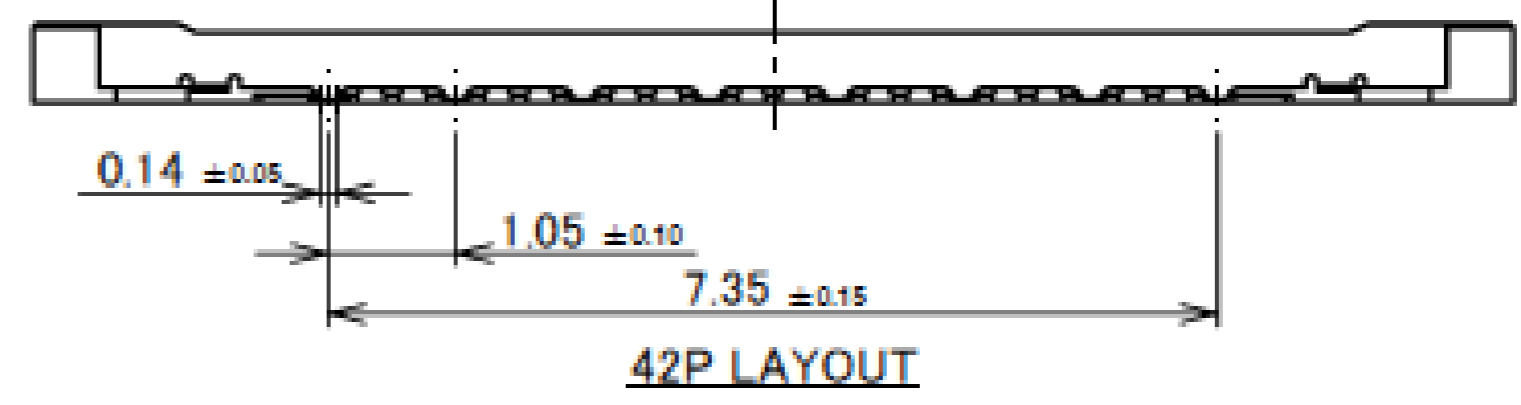
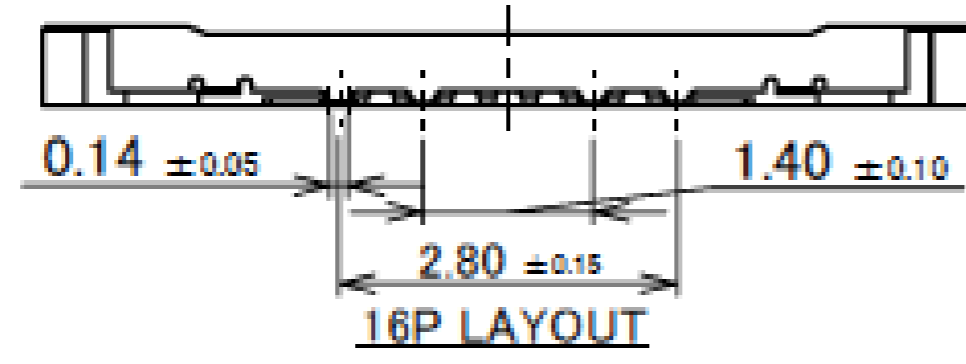

Rev.9

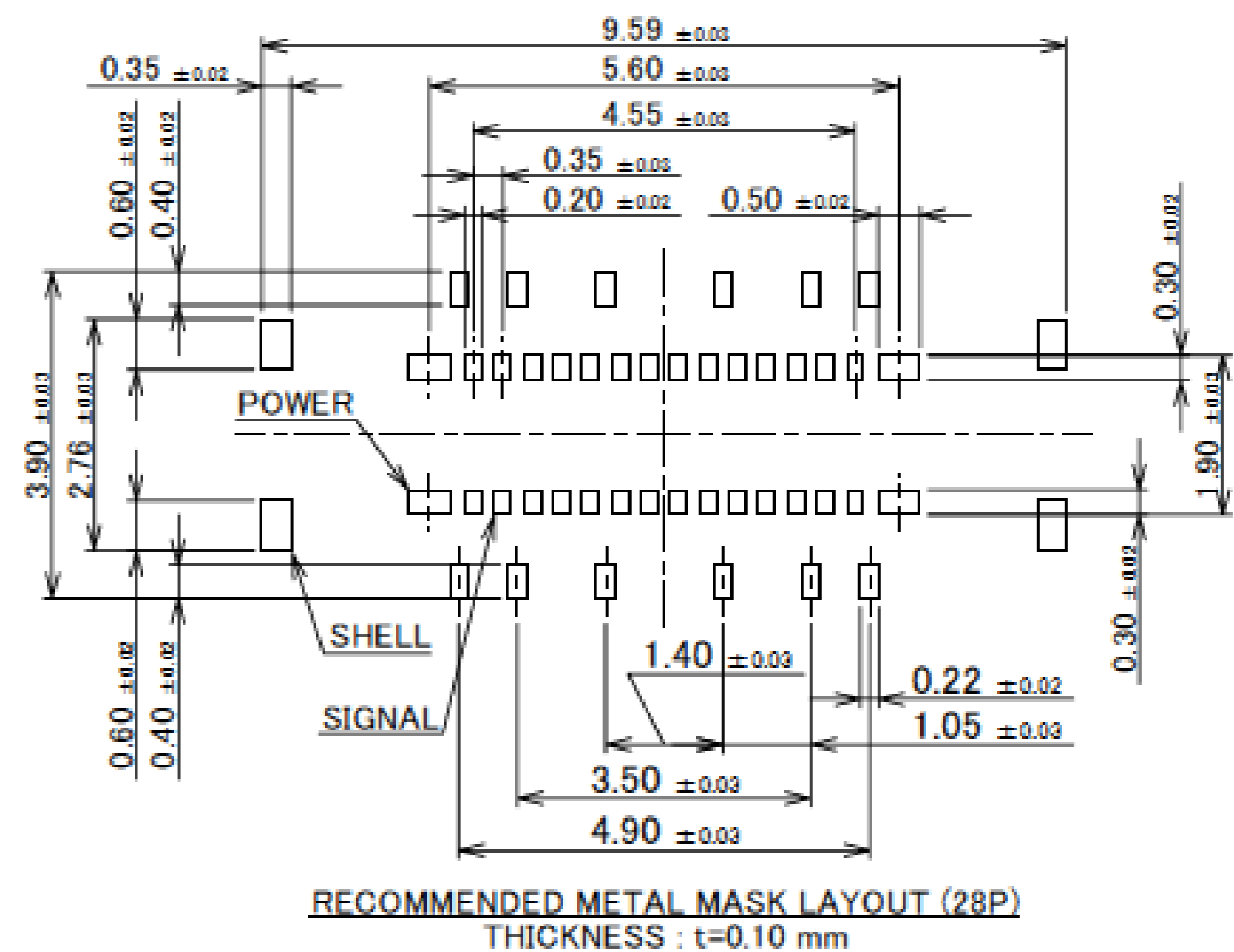
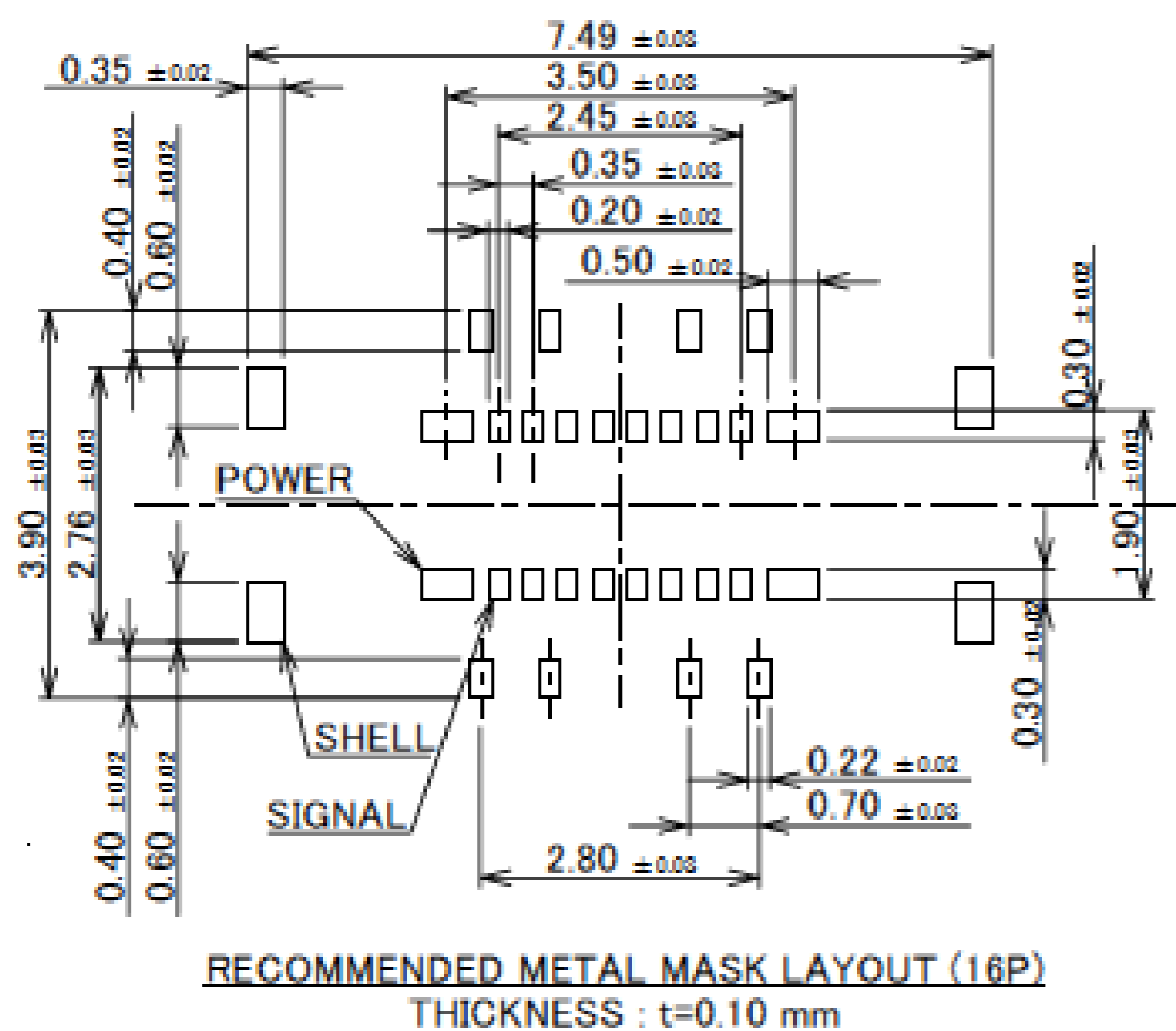
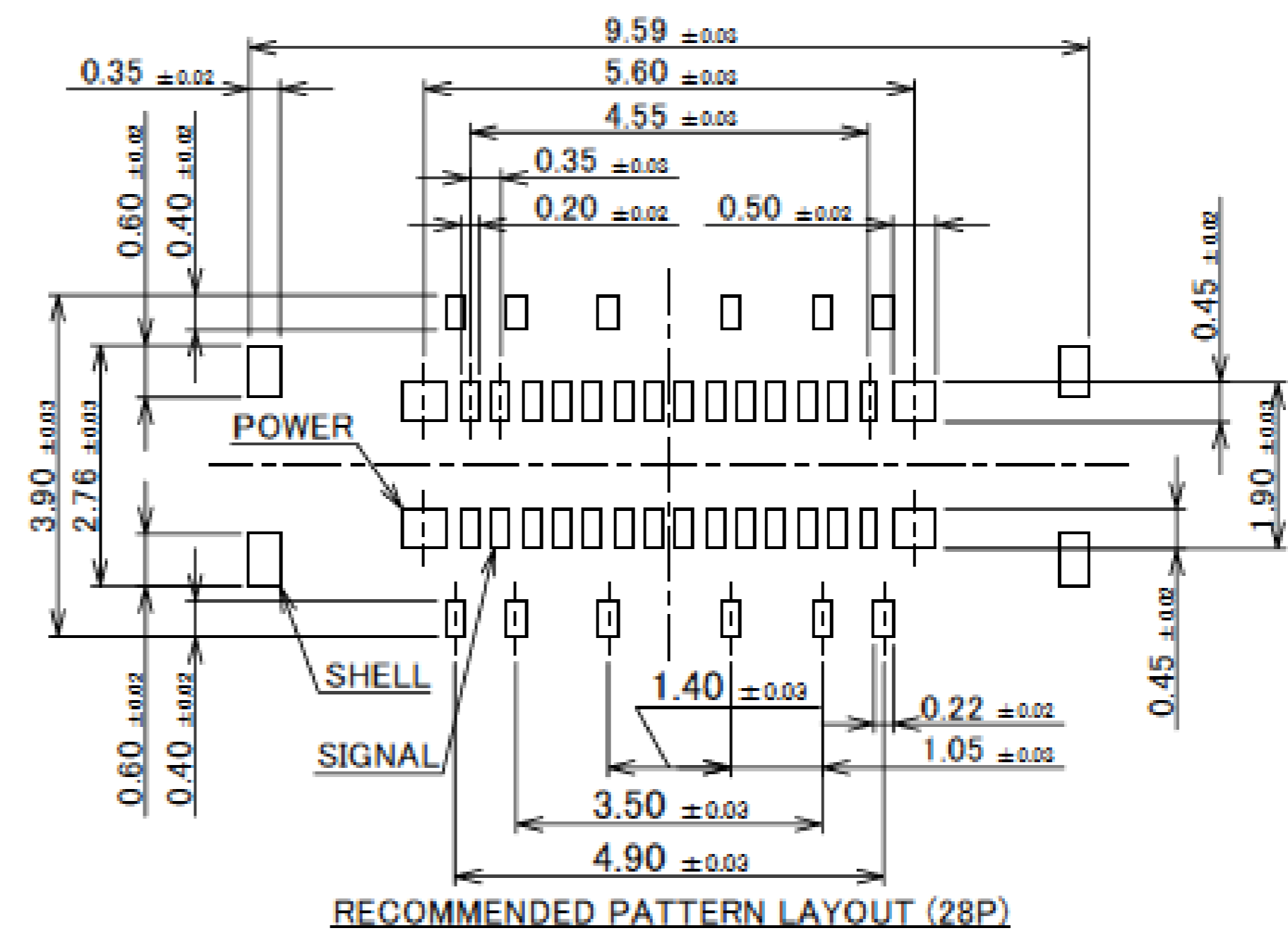
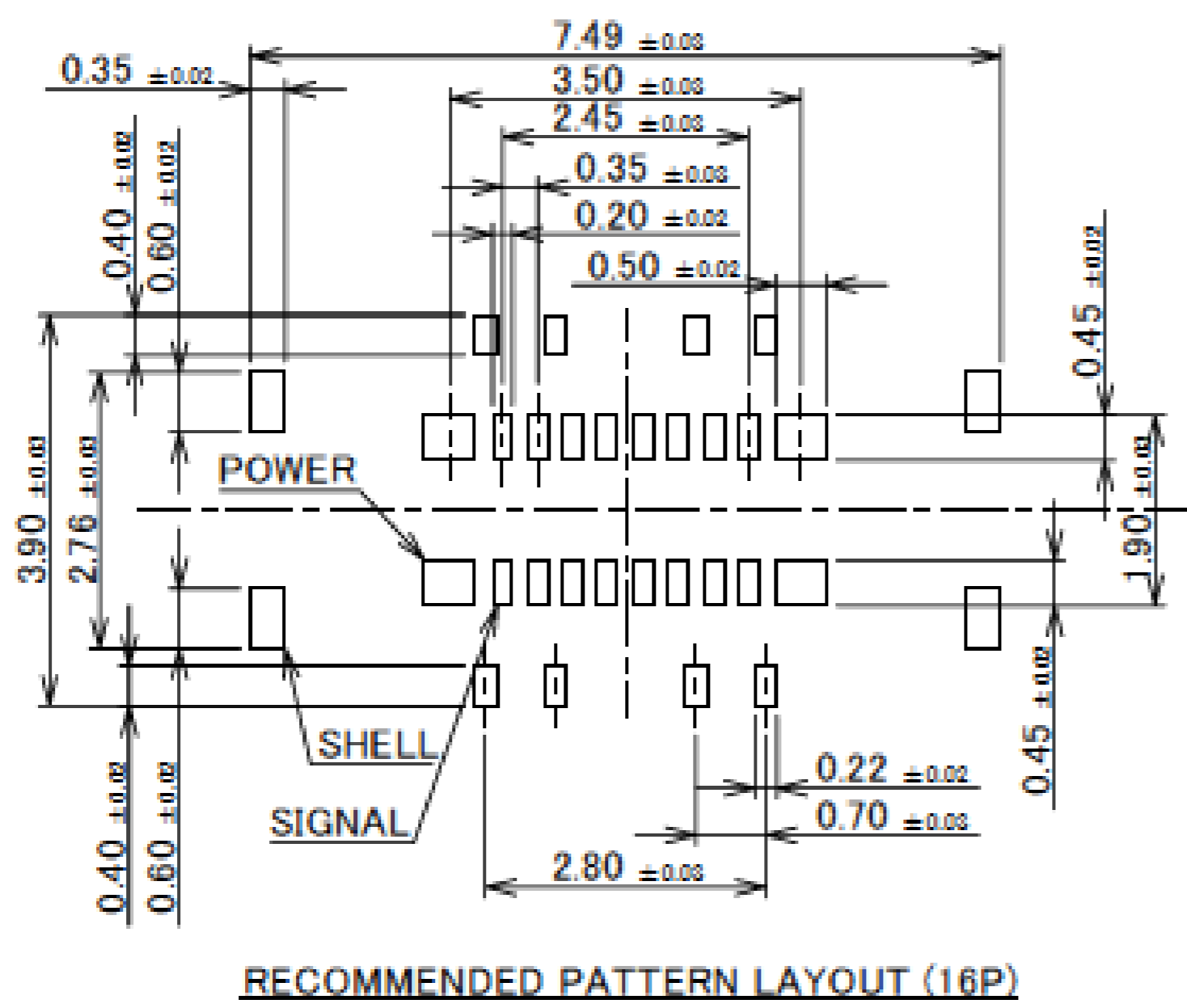

Rev.9



# Plug Assembly

PART No.	SIGNAL POS.	POWER POS.	A
20697-016E-01-P	16P	4P	7.99
20697-028E-01	28P	4P	10.09
20697-034E-01	34P	4P	11.14
20697-042E-01#	42P	4P	12.54
20697-056E-01#	56P	4P	14.99
20697-062E-01#	62P	4P	16.04

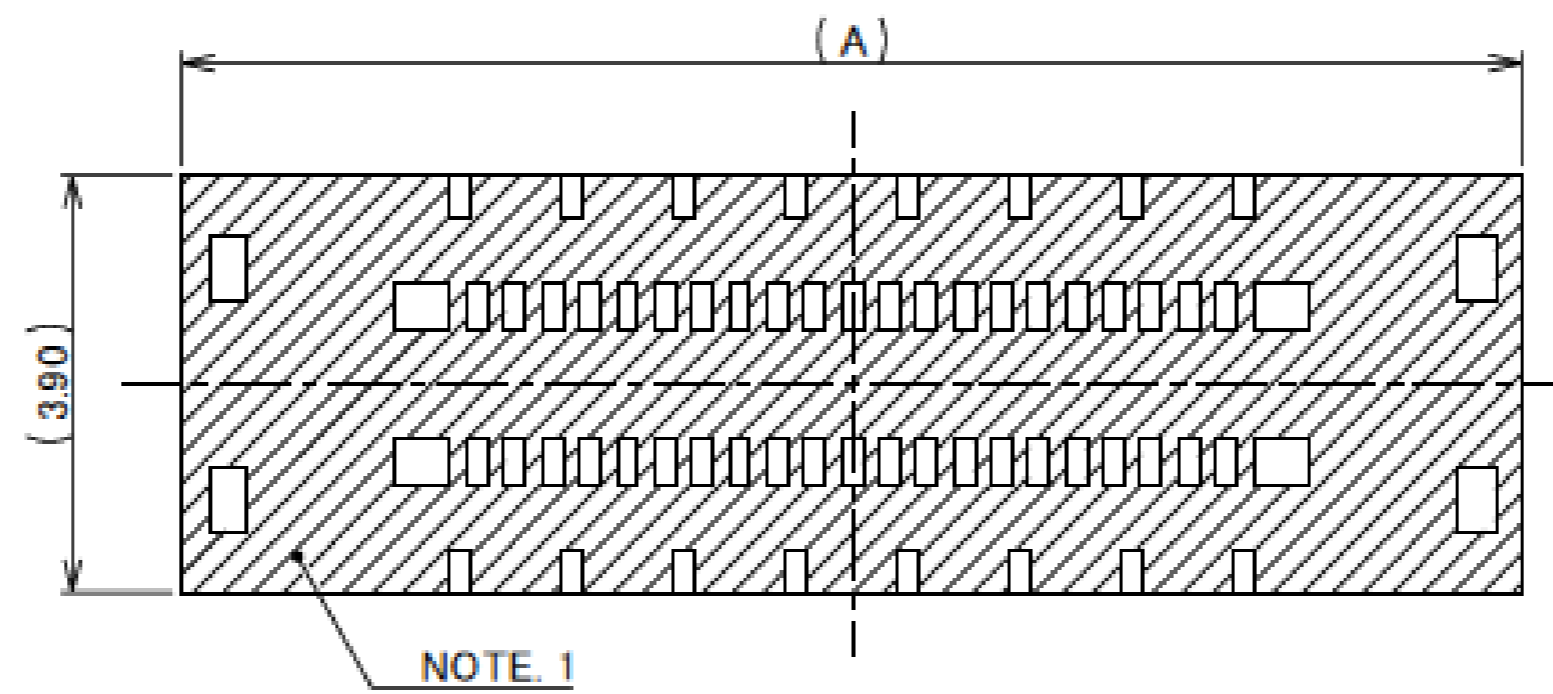

NOTES.  
1. THIS AREA CANNOT MOUNT ANOTHER COMPONENTS.

Rev.9

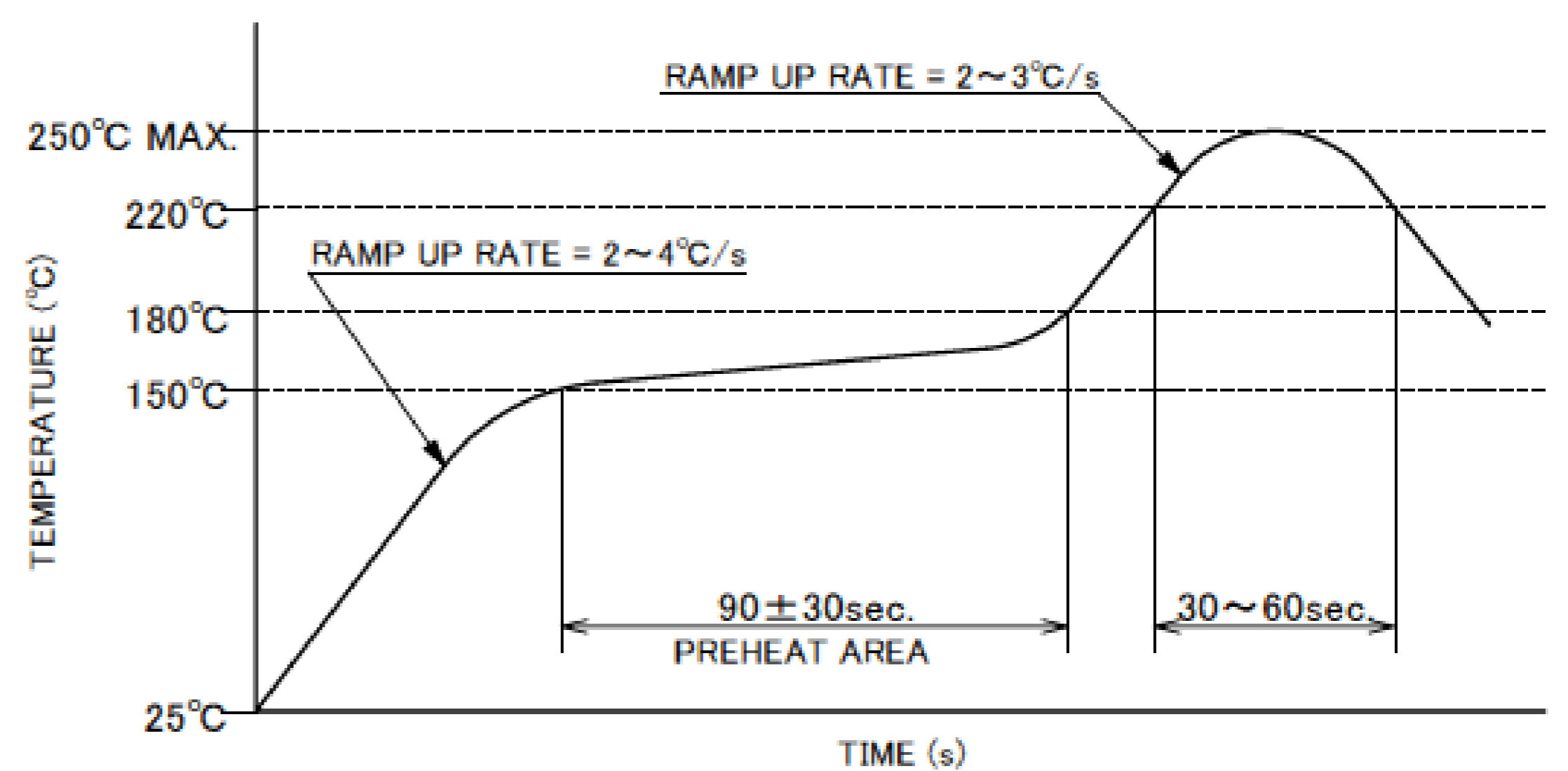
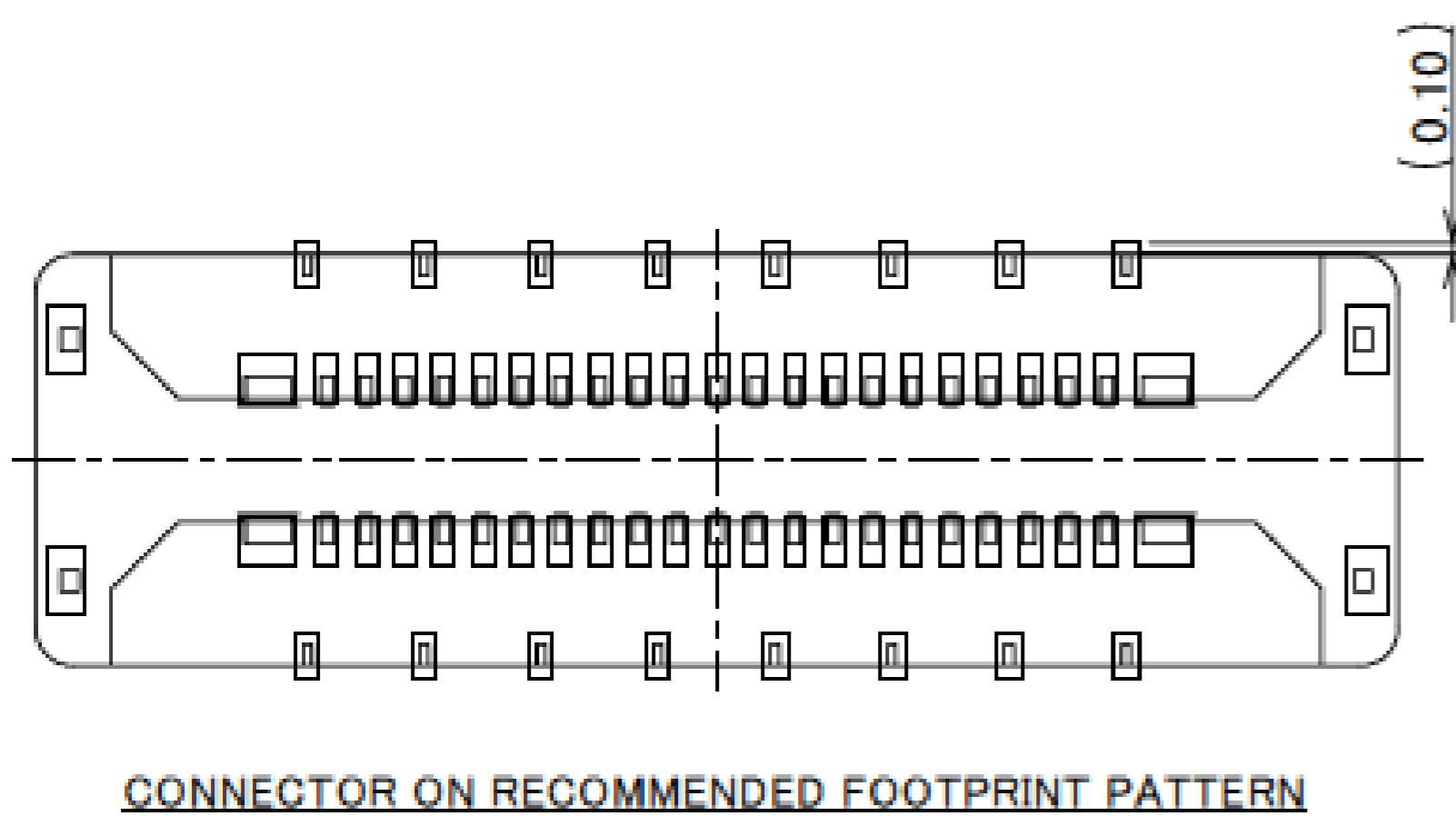

REFLOW TEMPERATURE PROFILE  
SENJU METAL INDUSTRY CO., LTD. : M705-SHF(Sn96.5 Ag3.0 Cu0.5)

Rev.9

# Plug Assembly

ITEMS	SPECIFICATION
APPLICABLE CONNECTOR PART No.	20698-0**E-01*
RATING VOLTAGE	60V AC (PER CONTACT PIN)
RATING AMPERAGE (FOR SIGNAL CONTACT)	0.3A AC/DC (PER CONTACT PIN)/ 12.0A AC/DC(TOTAL)
RATING AMPERAGE (FOR POWER CONTACT)	2.2A AC/DC (PER CONTACT PIN)/ 8.8A AC/DC(TOTAL)
OPERATING TEMPERATURE	233~358K(-40°C~+85°C)
OPERATING HUMIDITY	85% MAX.(NON-CONDENSING)
CONTACT RESISTANCE (FOR SIGNAL CONTACT)	INITIAL : 40mohm MAX. / AFTER TEST : $\triangle$ 40mohm MAX.
CONTACT RESISTANCE (FOR POWER CONTACT)	INITIAL : 20mohm MAX. / AFTER TEST : $\triangle$ 20mohm MAX.
CONTACT RESISTANCE (FOR GROUND)	INITIAL : 20mohm MAX. / AFTER TEST : $\triangle$ 20mohm MAX.
INSULATION RESISTANCE	INITIAL : 1,000Mohm MIN. / AFTER TEST : 500Mohm MIN.
DIELECTRIC WITHSTANDING VOLTAGE	AC250V 1min
DURABILITY	30 CYCLES
MATING FORCE (INITIAL)	16P : 32.0N MAX. 28P : 32.0N MAX. 34P : 38.0N MAX. 42P : 46.0N MAX. 56P : 60.0N MAX. 62P : 66.0N MAX.
UNMATING FORCE (AFTER TEST)	16P : 3.2N MIN. 28P : 3.2N MIN. 34P : 3.8N MIN. 42P : 4.6N MIN. 56P : 6.0N MIN. 62P : 6.6N MIN.
COPLANARITY	CONTACT AND POWER CONTACT: 0.08 MAX. SHELL: 0.105 MAX.
PRODUCT SPECIFICATION	PRS-2187
TEST REPORT	TR-16014
PACKING STANDARD	PST-15083 (10K/REEL) PST-16125 (5K/REEL)
INSTRUCTION MANUAL	HIM-15020
APPEARANCE CRITERIA No.	QLS-A***

Rev.9

# Receptacle Assembly

Recommended P/N	20698-0**E-01#					
PART No.	SIGNAL POS.	POWER POS.	A	B	C	D
20698-016E-01	16P	4P	6.85	4.44	3.50	2.45
20698-028E-01	28P	4P	8.95	6.54	5.60	4.55
20698-034E-01	34P	4P	10.00	7.59	6.65	5.60
20698-042E-01#	42P	4P	11.40	8.99	8.05	7.00
20698-056E-01#	56P	4P	13.85	11.44	10.50	9.45
20698-062E-01#	62P	4P	14.90	12.49	11.55	10.50

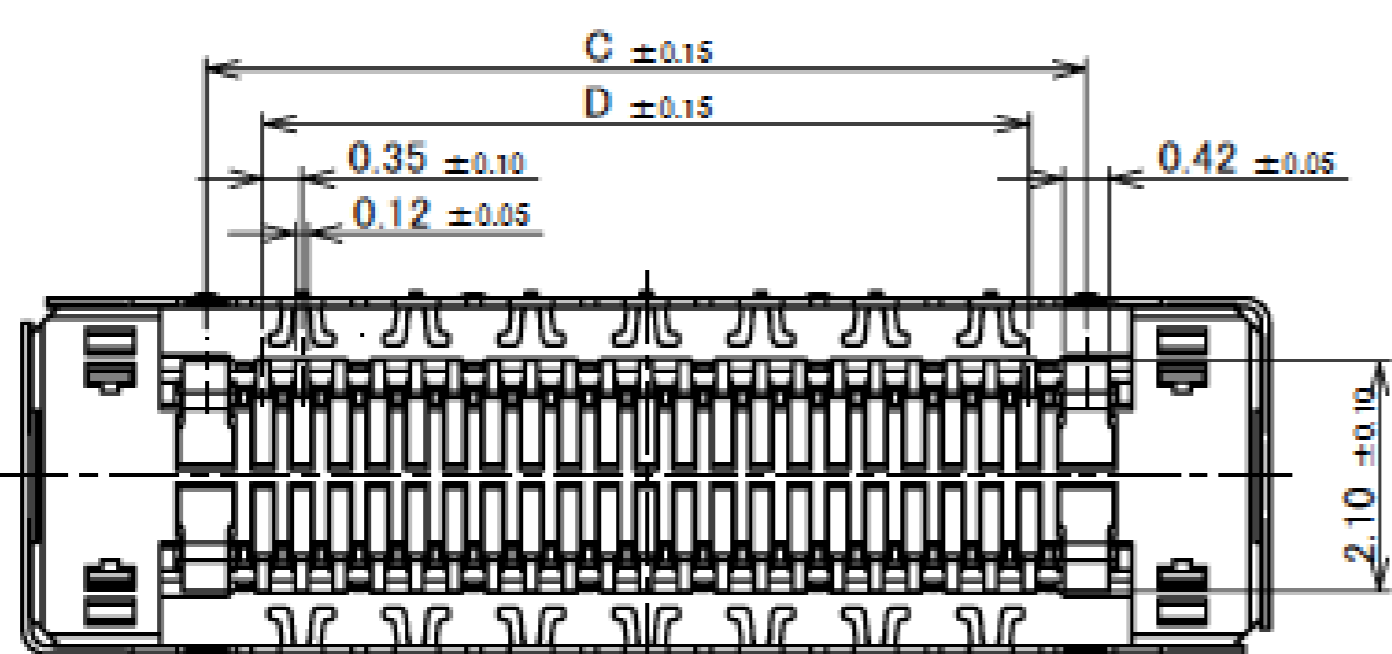
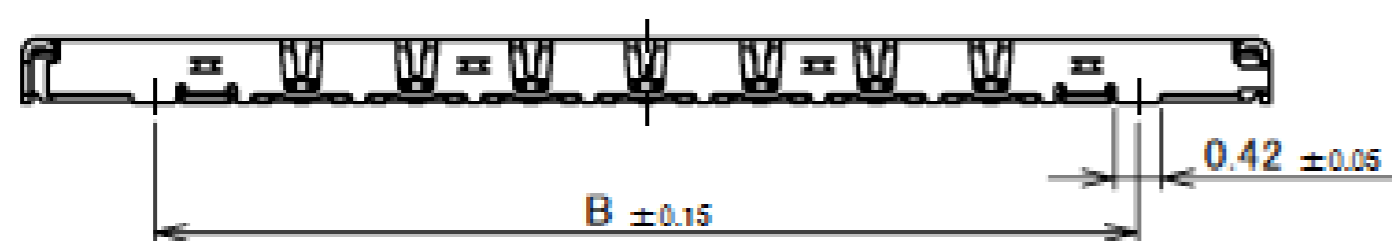
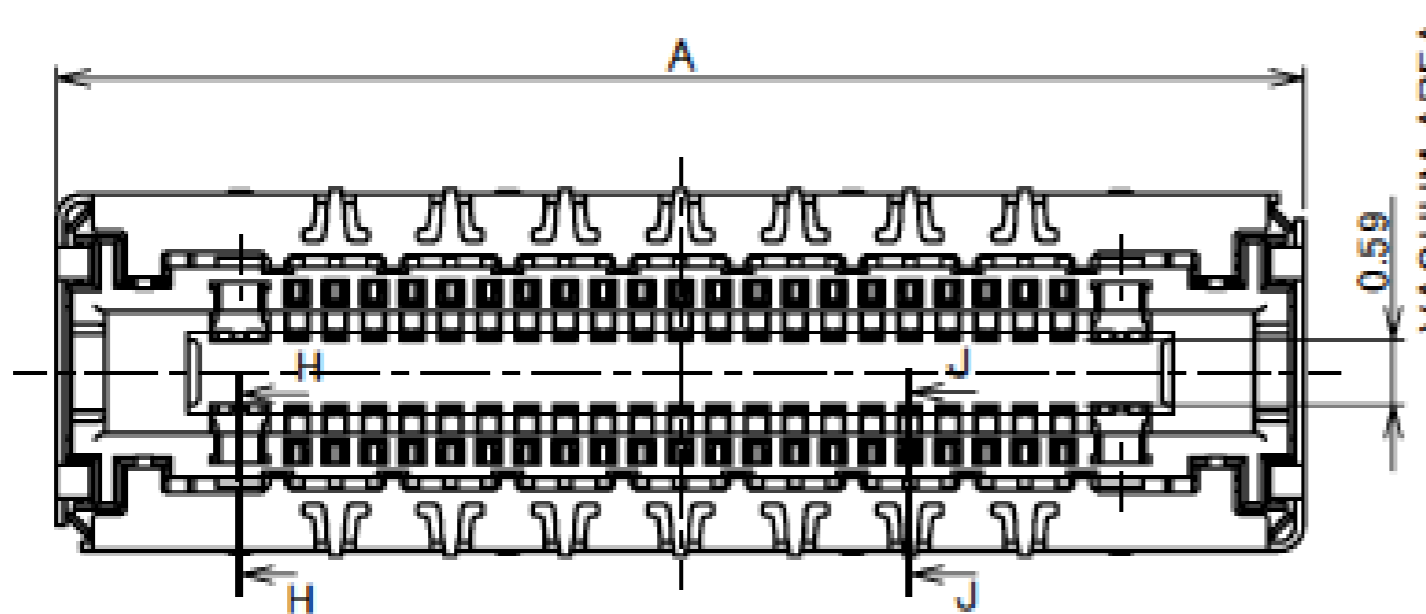

20698-0\*\*E-01M  
WITHOUT : 10,000 pcs/REEL  
WITH : 5,000 pcs/REEL  
Pos.

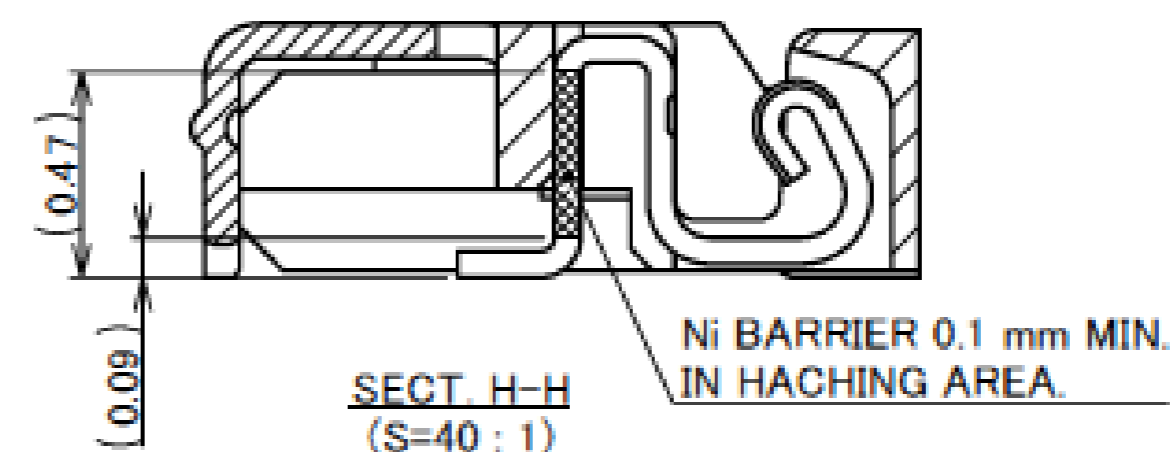
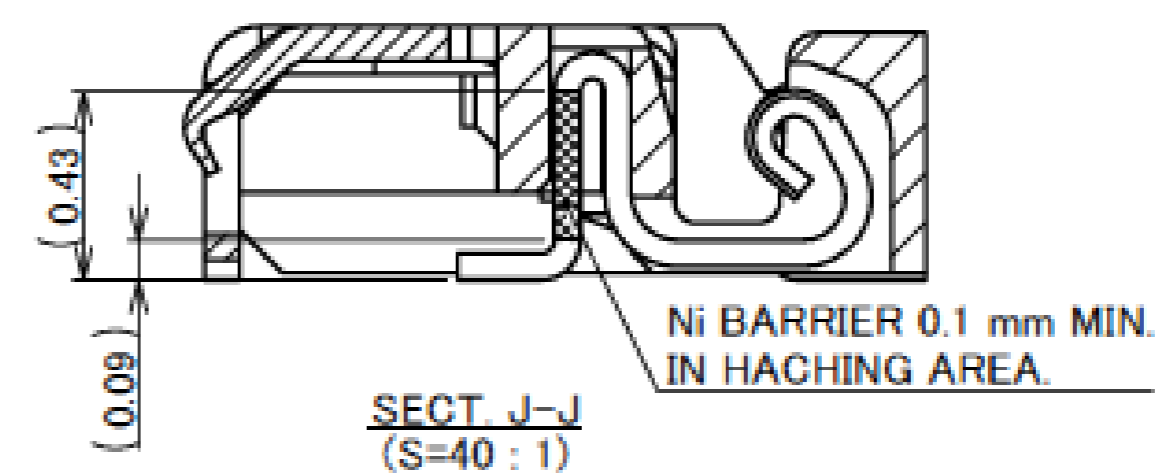
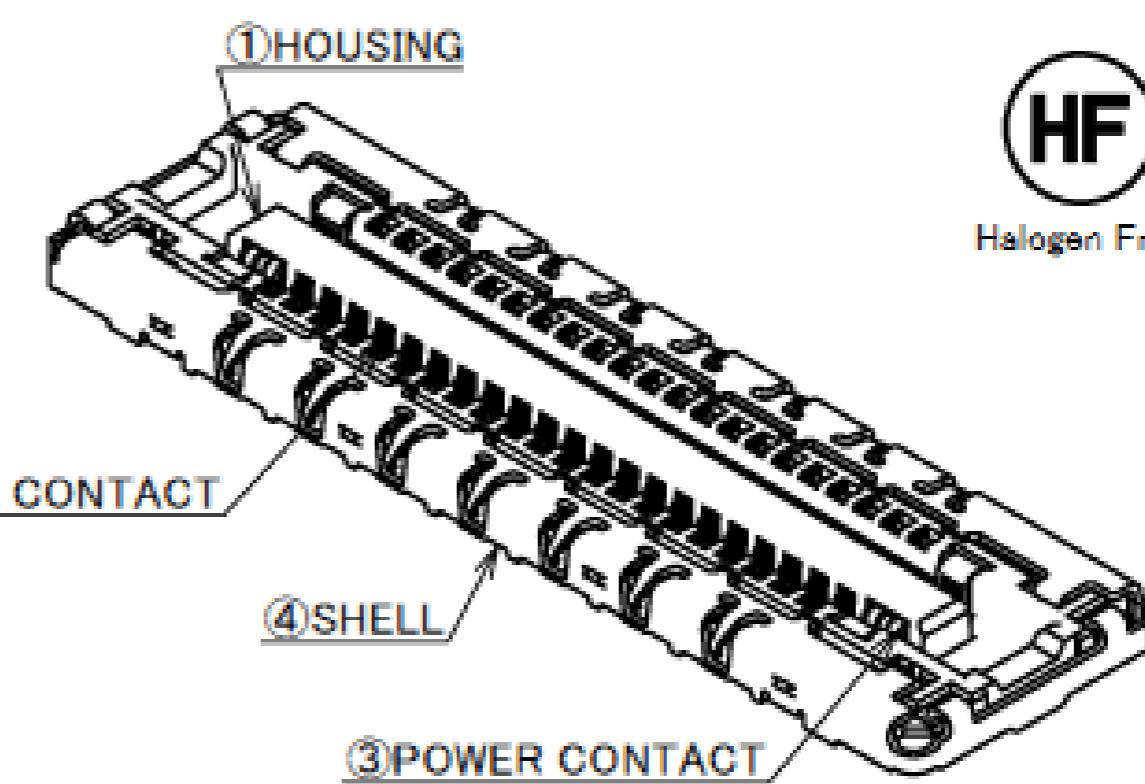
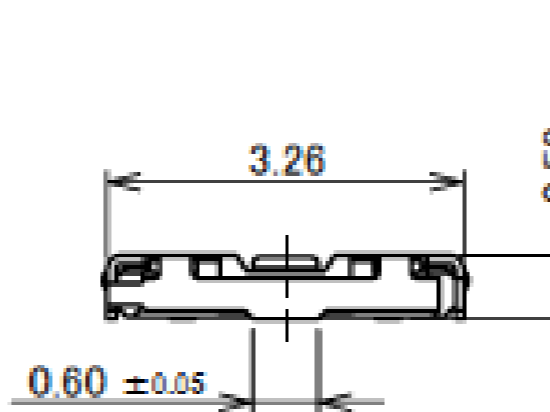
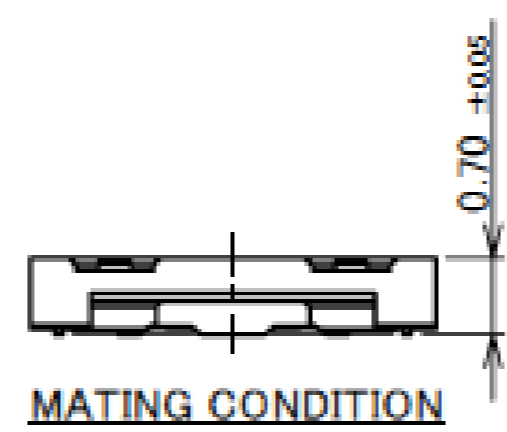

NO.	DISCRIPTION	MATERIAL	FINISH , REMARKS
4	SHELL	PHOSPHOR BRONZE	ALL OVER Ni 1.27 $\mu$ m MIN. Au 0.01 $\mu$ m MIN.
3	POWER CONTACT	CORSON ALLOY	ALL OVER Ni 1.27 $\mu$ m MIN. CONTACT PART Au 0.05 $\mu$ m MIN. SOLDERING PART Au 0.02 $\mu$ m MIN.
2	SIGNAL CONTACT	CORSON ALLOY	ALL OVER Ni 1.27 $\mu$ m MIN. CONTACT PART Au 0.10 $\mu$ m MIN. SOLDERING PART Au 0.02 $\mu$ m MIN.
1	HOUSING	LCP	UL94V-0, BLACK

Rev.12

# Receptacle Assembly

PART No.	SIGNAL POS.	POWER POS.
20698-016E-01	16P	4P
20698-028E-01	28P	4P
20698-034E-01	34P	4P
20698-042E-01#	42P	4P
20698-056E-01#	56P	4P
20698-062E-01#	62P	4P

20698-0\*\*E-01M  
 WITHOUT : 10,000 pcs/REEL  
 WITH : 5,000 pcs/REEL  
 Pos.

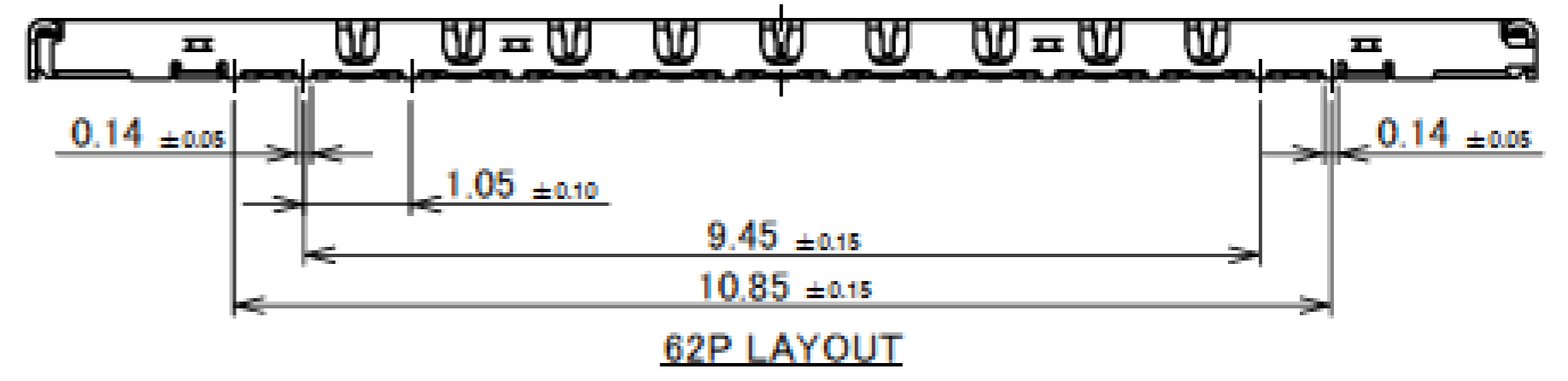
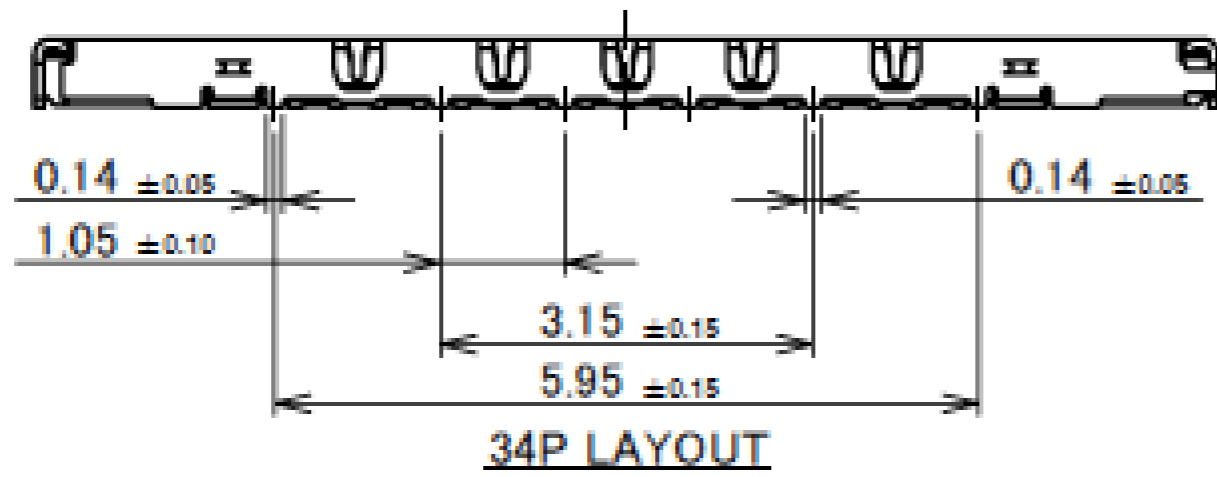
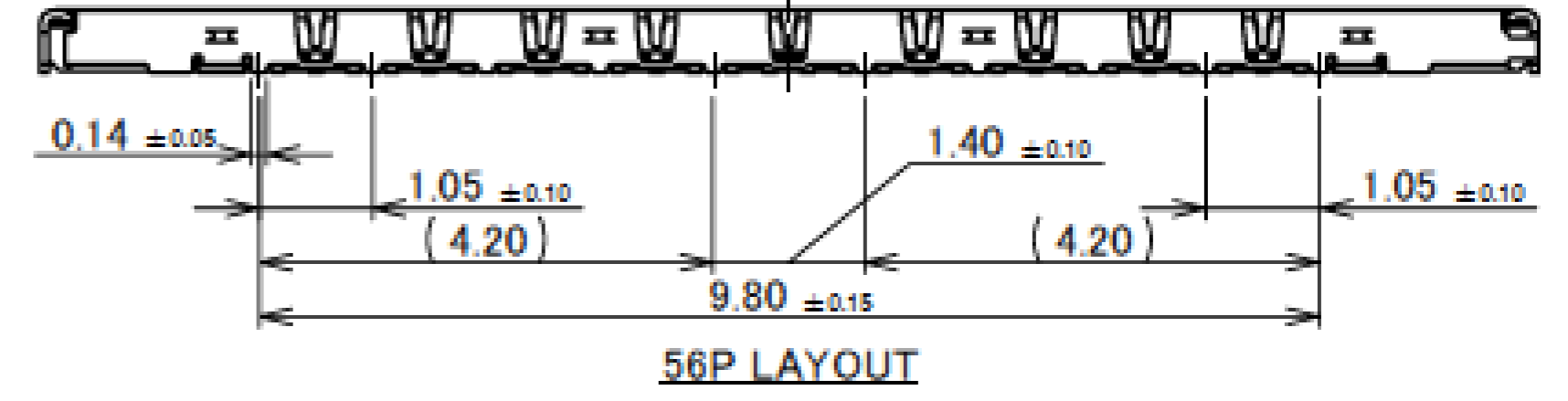
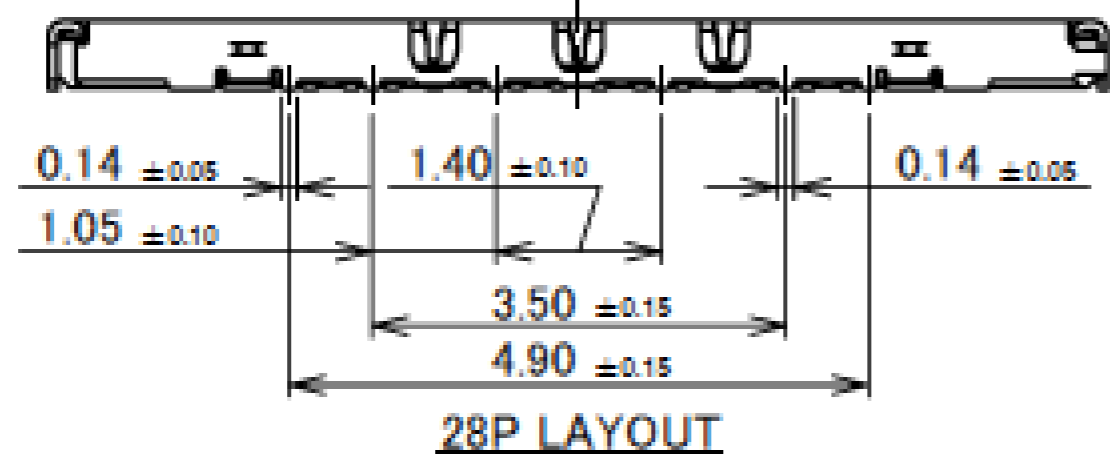
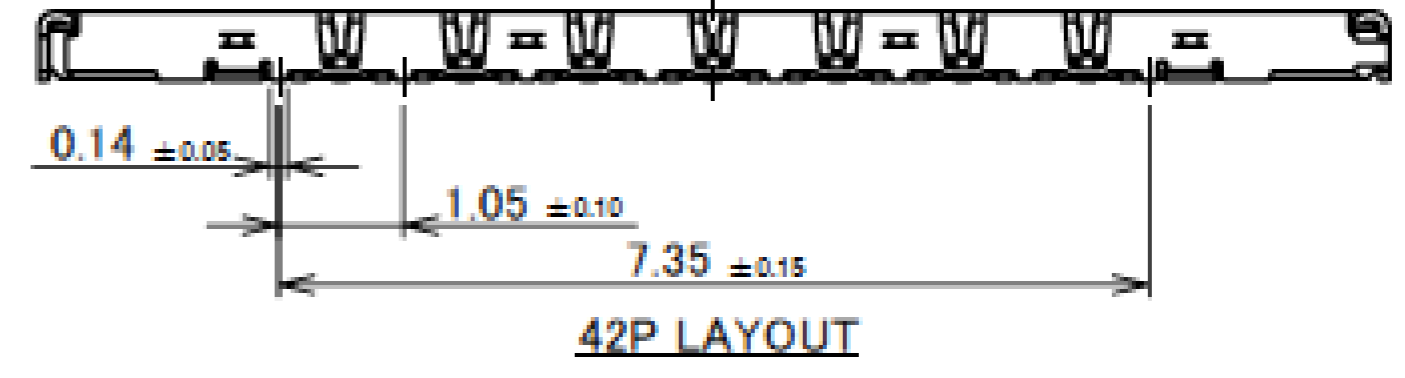
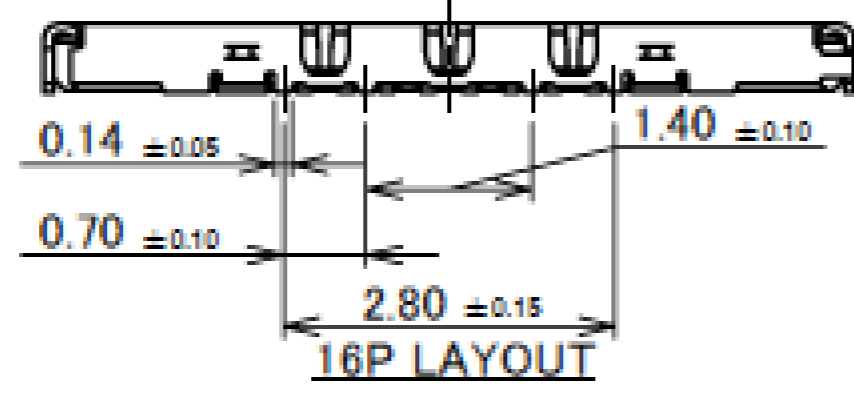

Rev.12

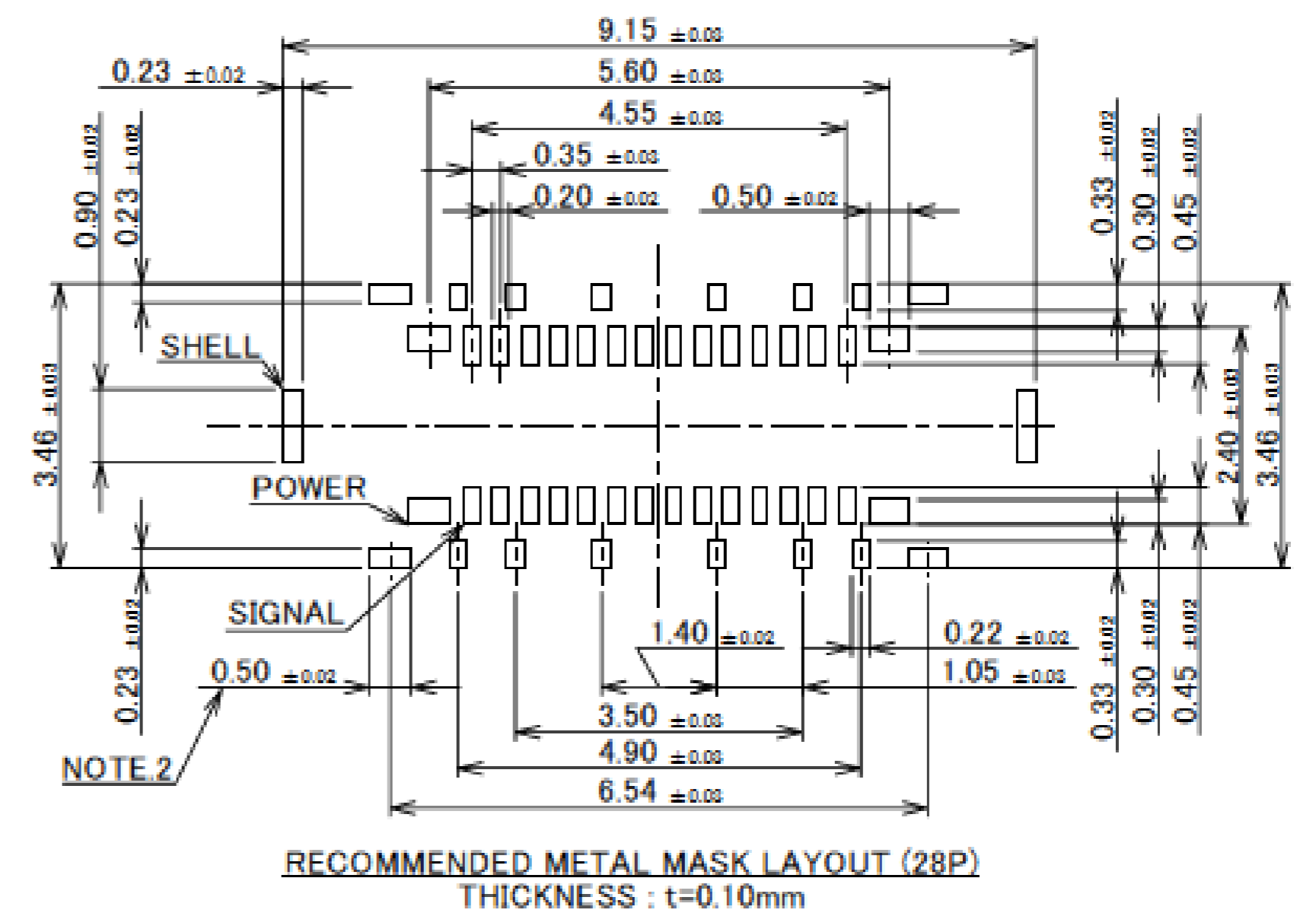
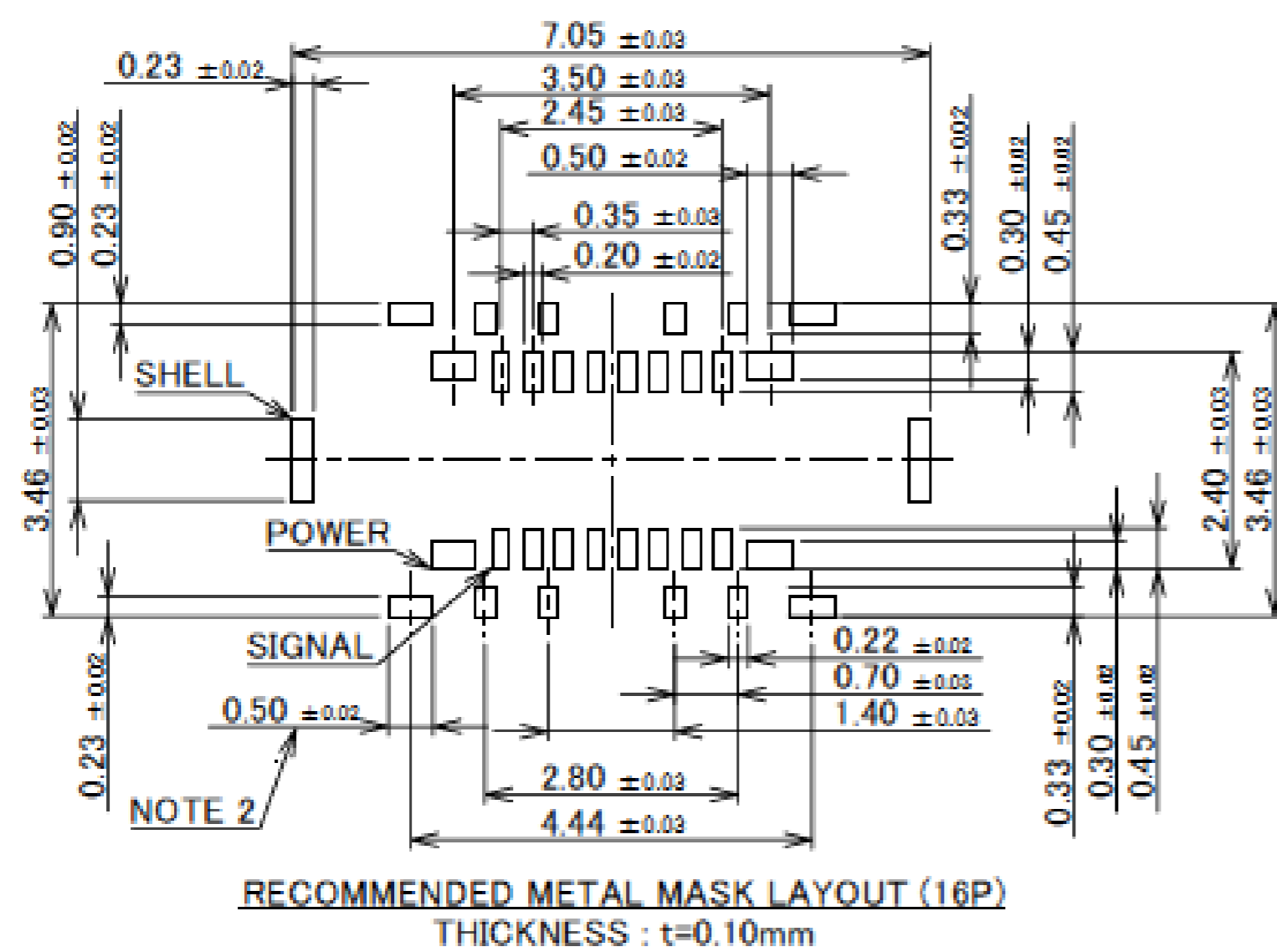
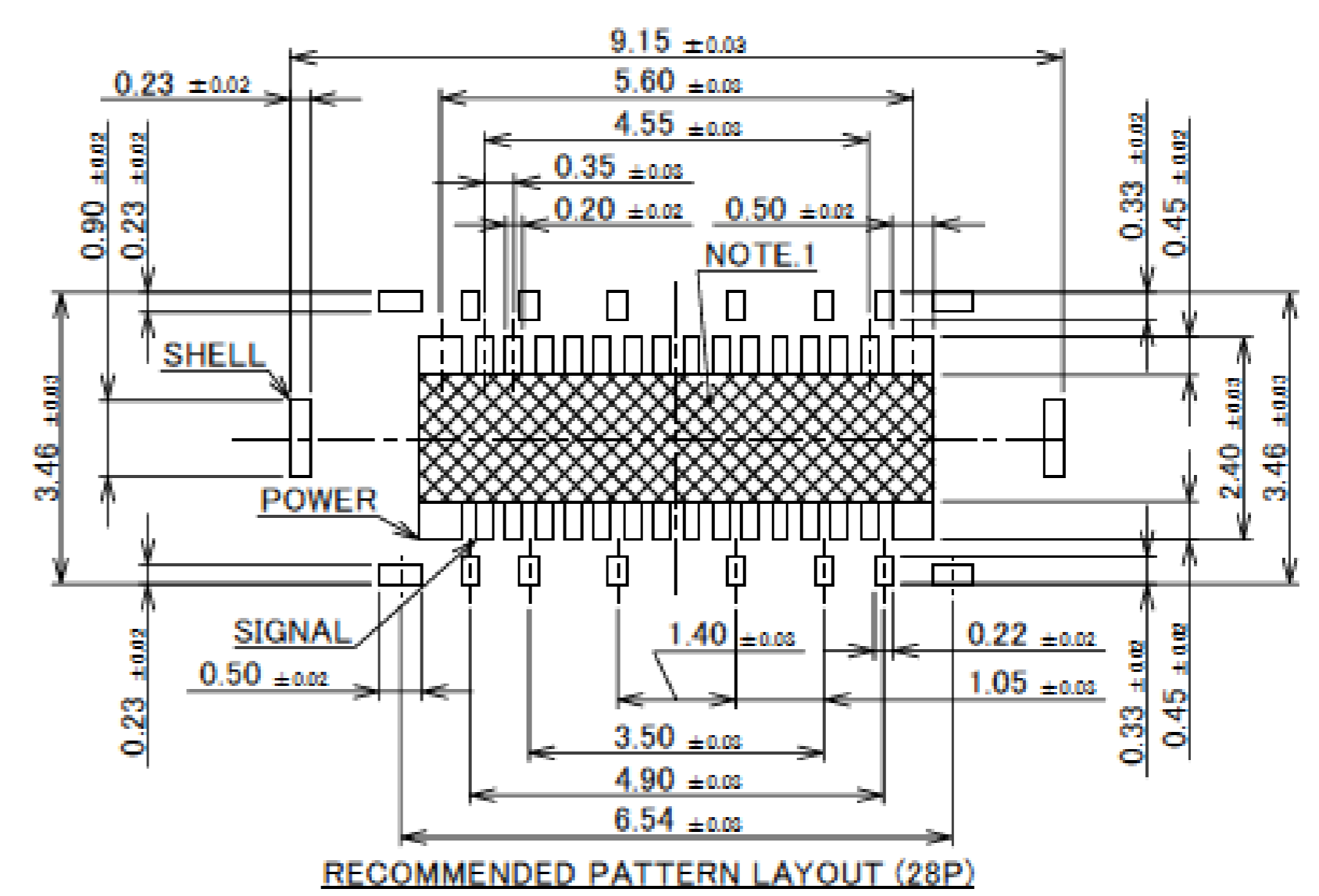
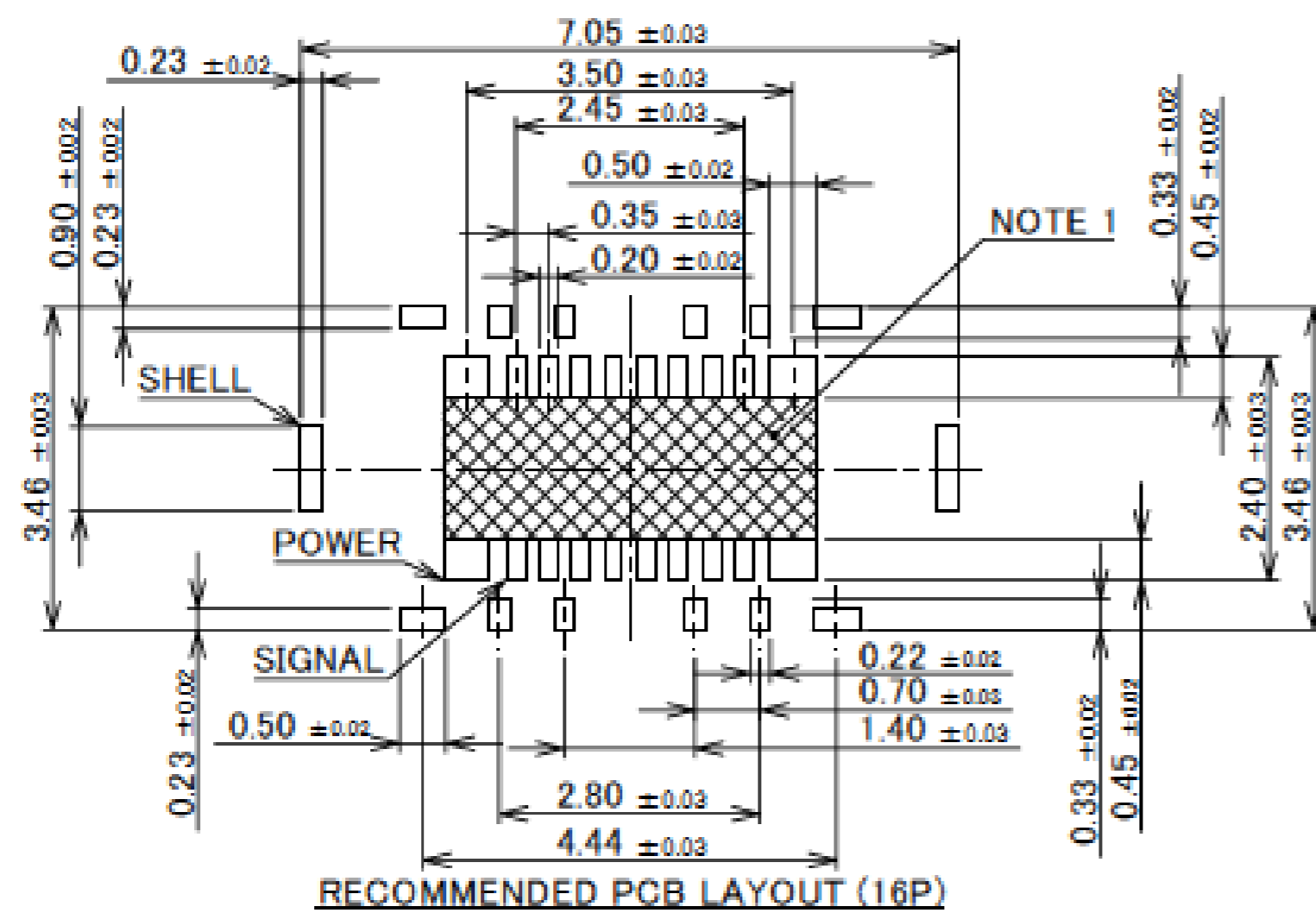

NOTES

1. SOLDER RESIST MUST BE APPLIED TO THIS AREA.
2. WHEN THE THICKNESS OF THE METAL MASK IS 0.12 mm, PLEASE SET IT TO 0.41 mm.

Rev.12

# Receptacle Assembly

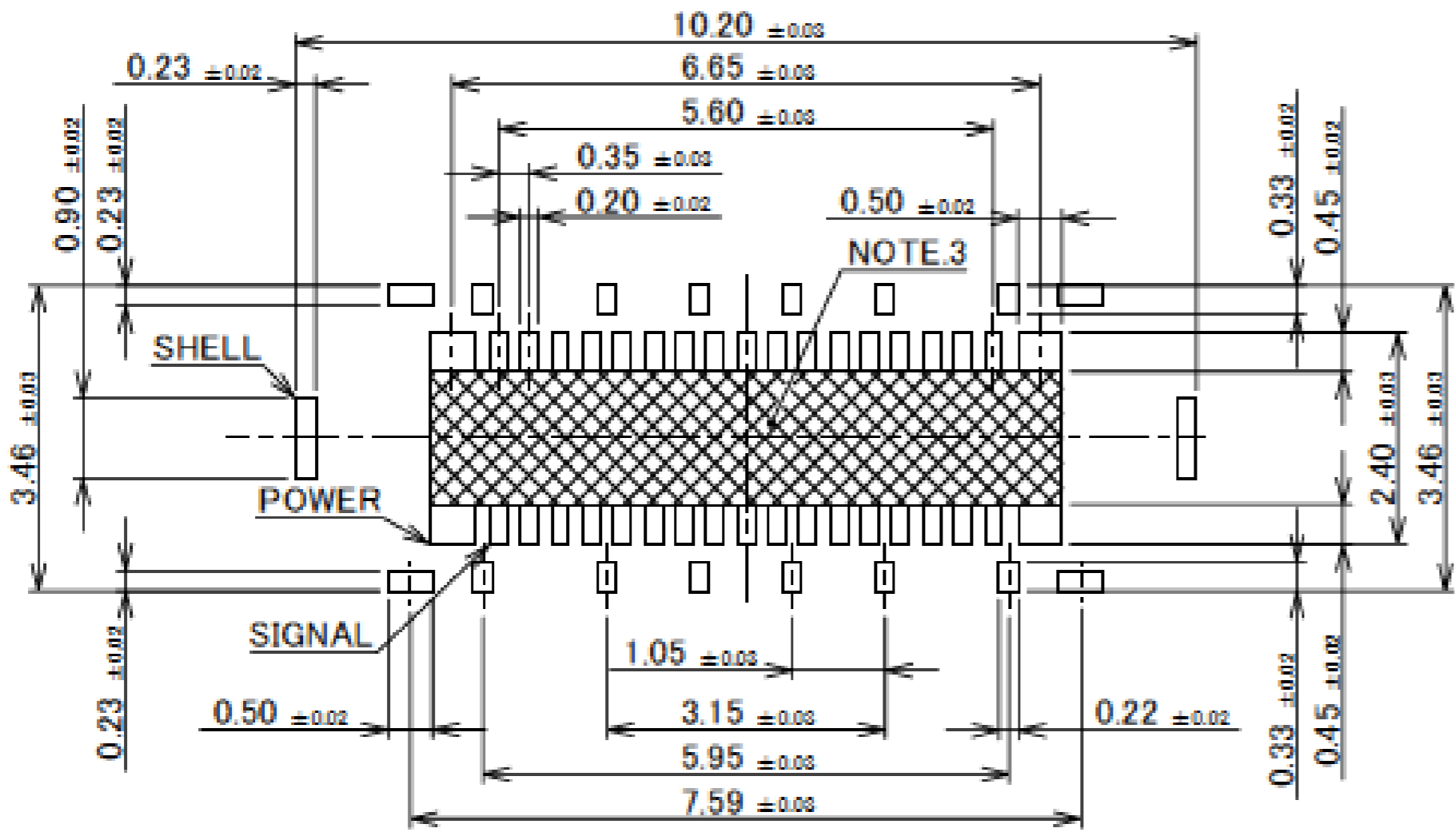

RECOMMENDED PATTERN LAYOUT (34P)

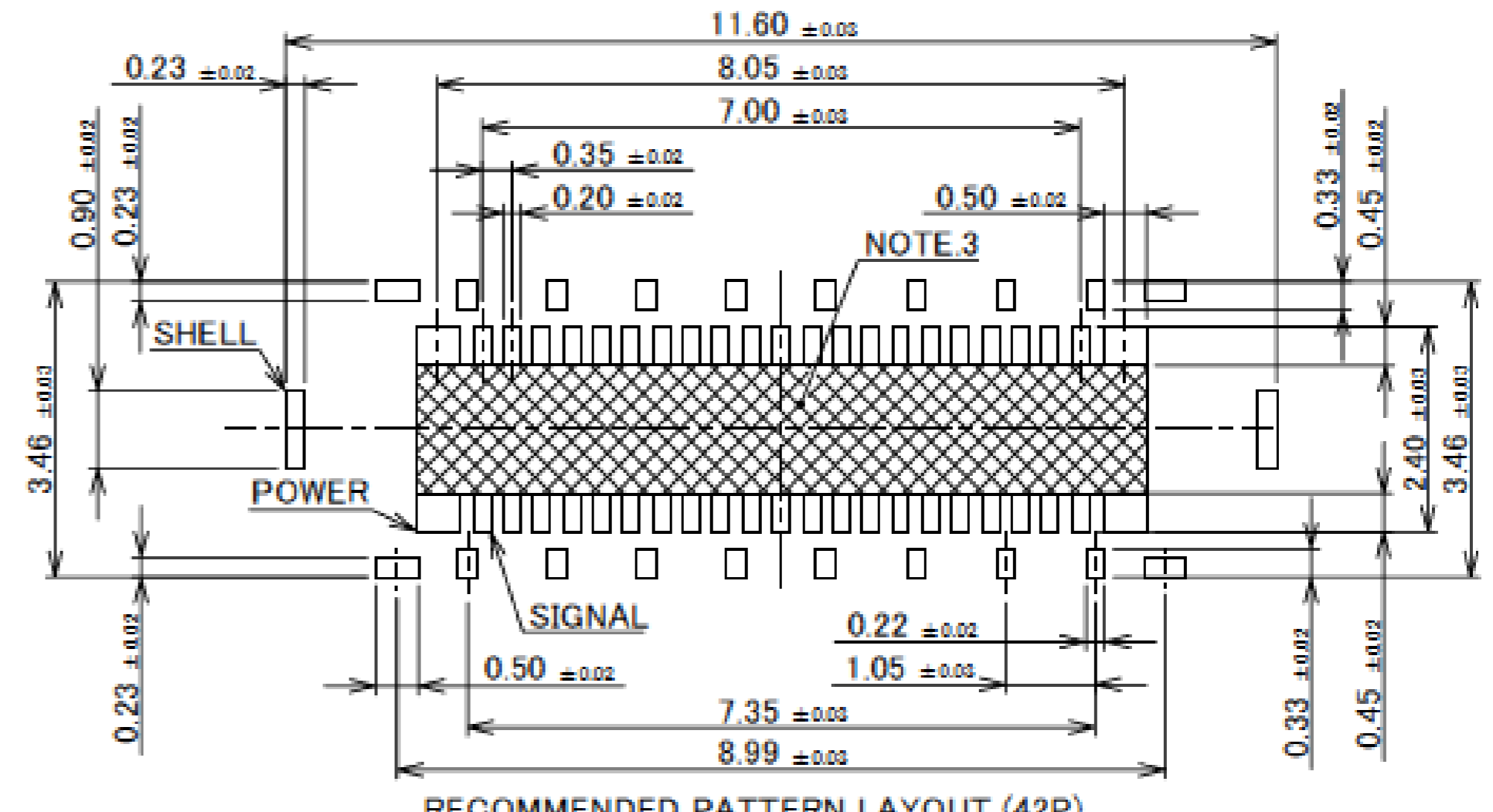

RECOMMENDED PATTERN LAYOUT (42P)

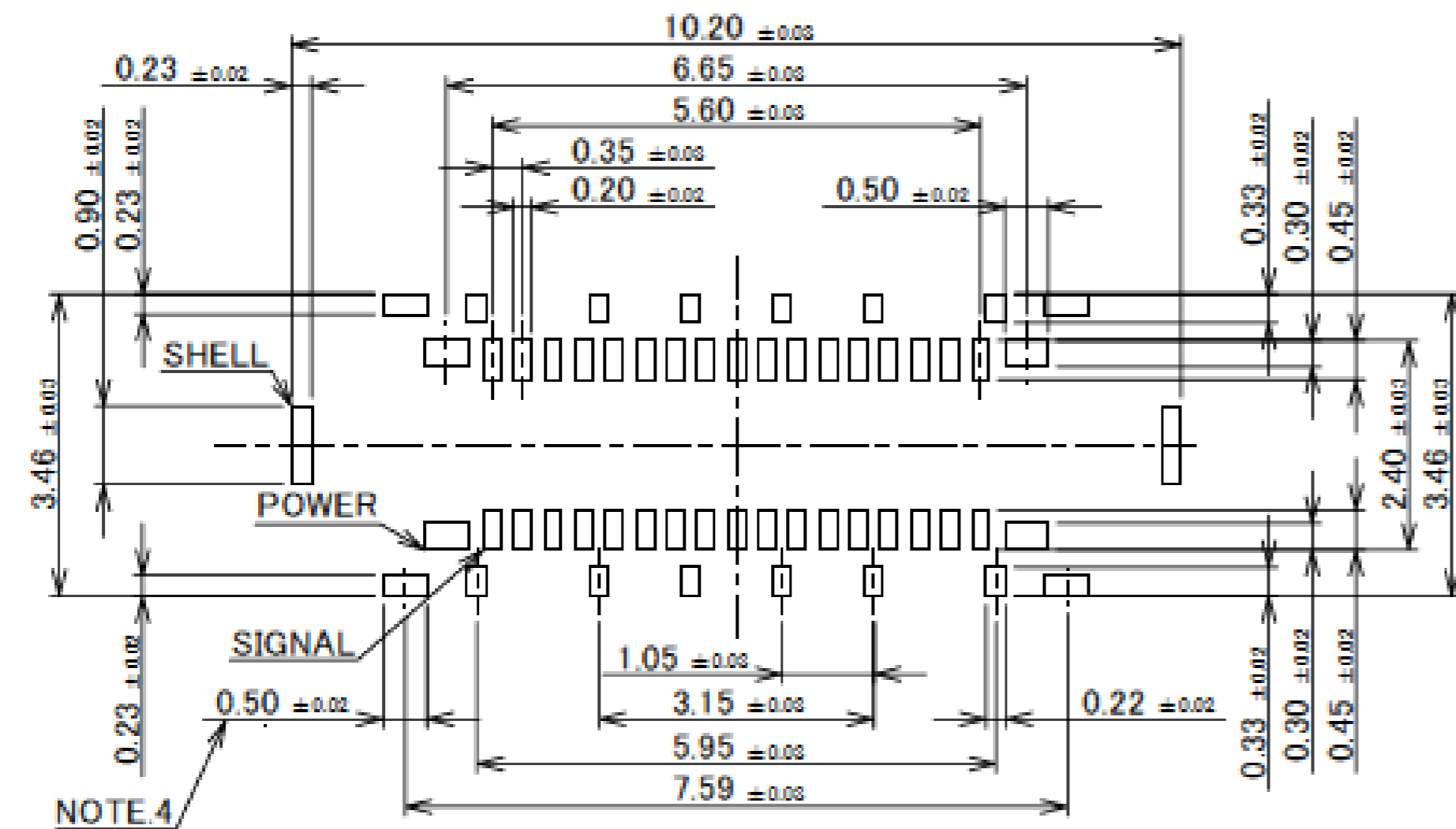

RECOMMENDED METAL MASK LAYOUT (34P)  
THICKNESS : t=0.10mm

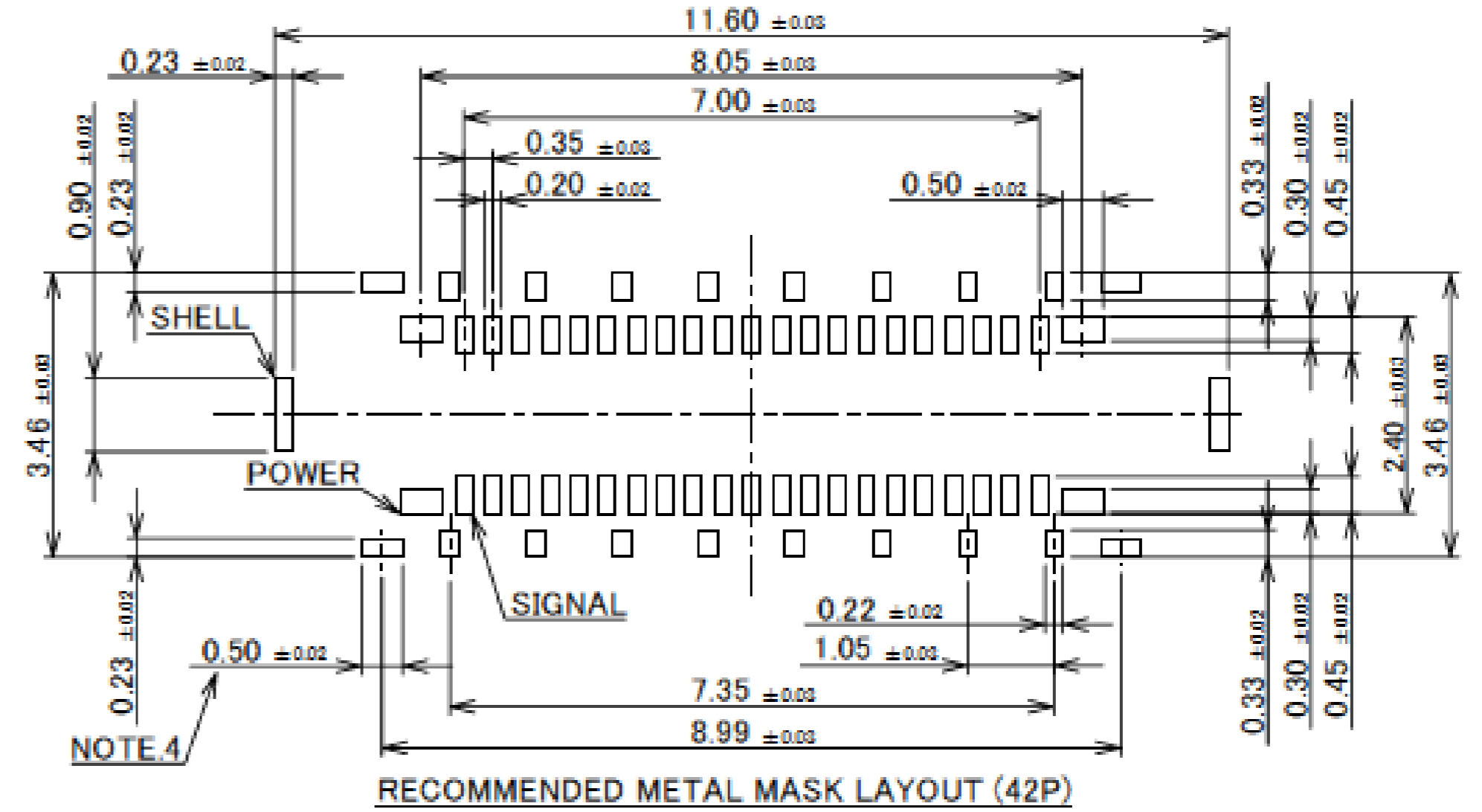

RECOMMENDED METAL MASK LAYOUT (42P)  
THICKNESS : t=0.10mm

**NOTES**

- 3. SOLDER RESIST MUST BE APPLIED TO THIS AREA.
- 4. WHEN THE THICKNESS OF THE METAL MASK IS 0.12 mm, PLEASE SET IT TO 0.41 mm.

Rev.12

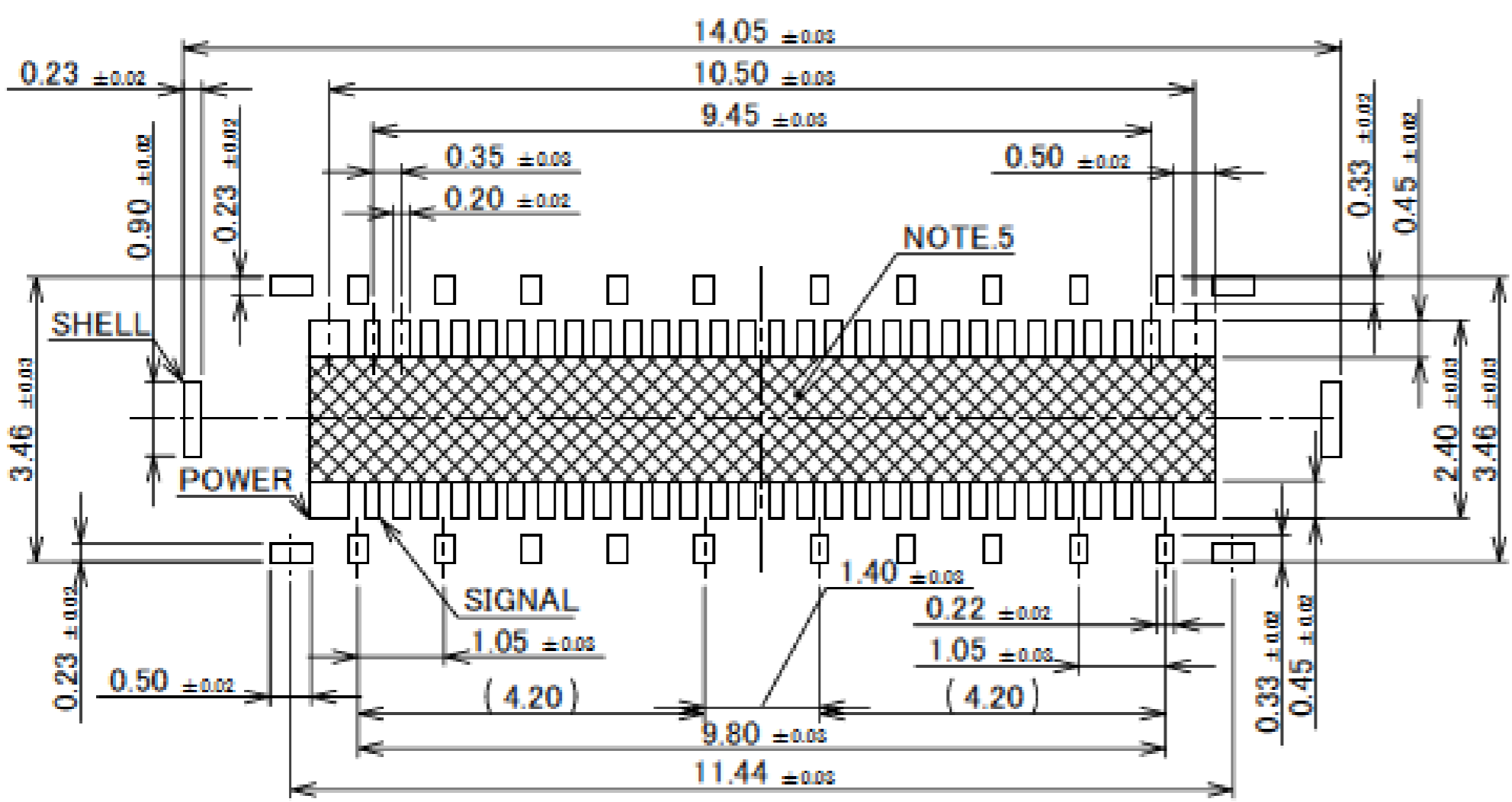

RECOMMENDED PATTERN LAYOUT (56P)

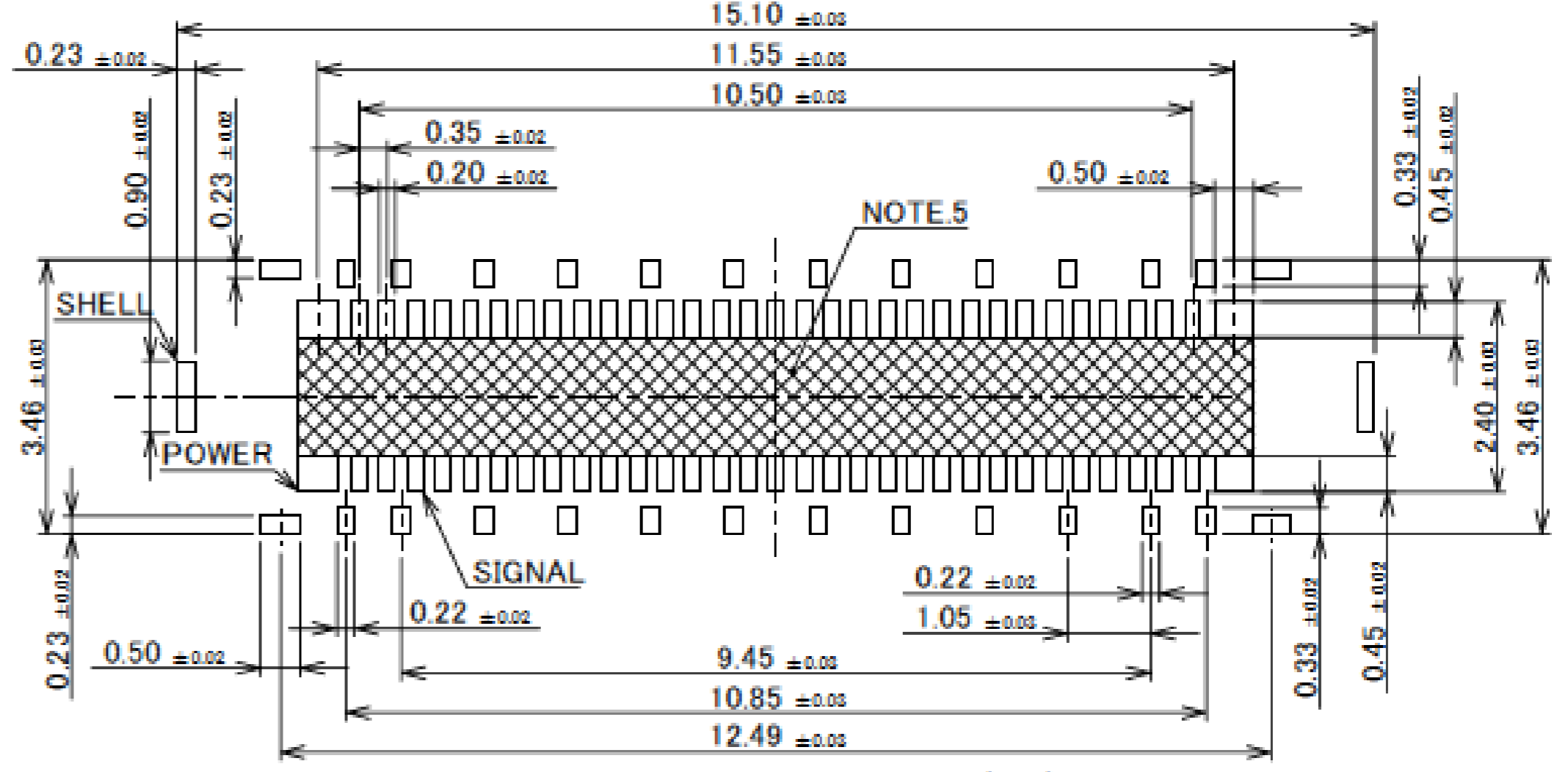

RECOMMENDED PATTERN LAYOUT (62P)

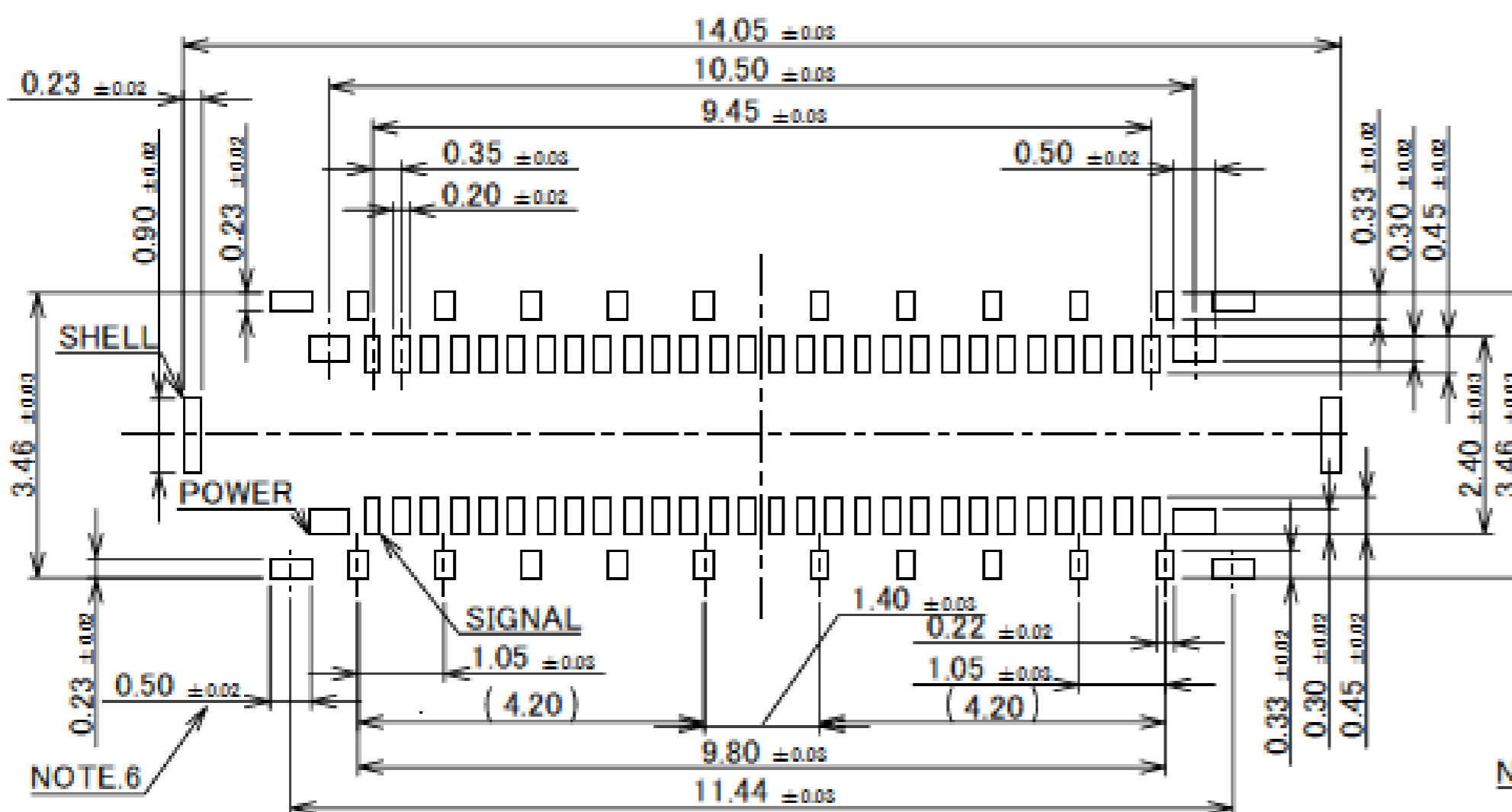

RECOMMENDED METAL MASK LAYOUT (56P)  
THICKNESS : t=0.10mm

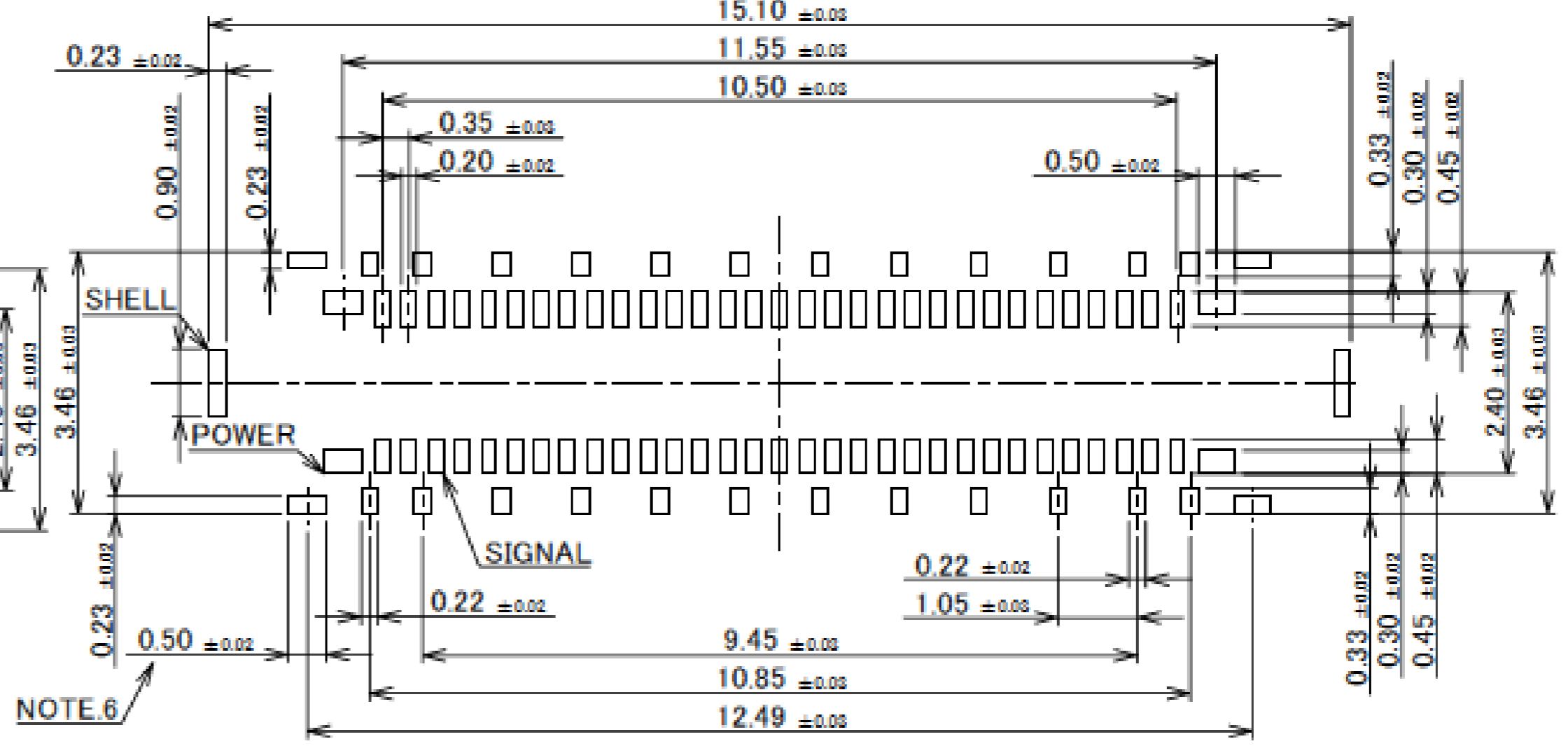

RECOMMENDED METAL MASK LAYOUT (62P)  
THICKNESS : t=0.10 mm

**NOTES**

- 5. SOLDER RESIST MUST BE APPLIED TO THIS AREA.
- 6. WHEN THE THICKNESS OF THE METAL MASK IS 0.12 mm, PLEASE SET IT TO 0.41 mm.

Rev.12

# Receptacle Assembly

PART No.	SIGNAL POS.	POWER POS.	E
20698-016E-01	16P	4P	7.99
20698-028E-01	28P	4P	10.09
20698-034E-01	34P	4P	11.14
20698-042E-01#	42P	4P	12.54
20698-056E-01#	56P	4P	14.99
20698-062E-01#	62P	4P	16.04

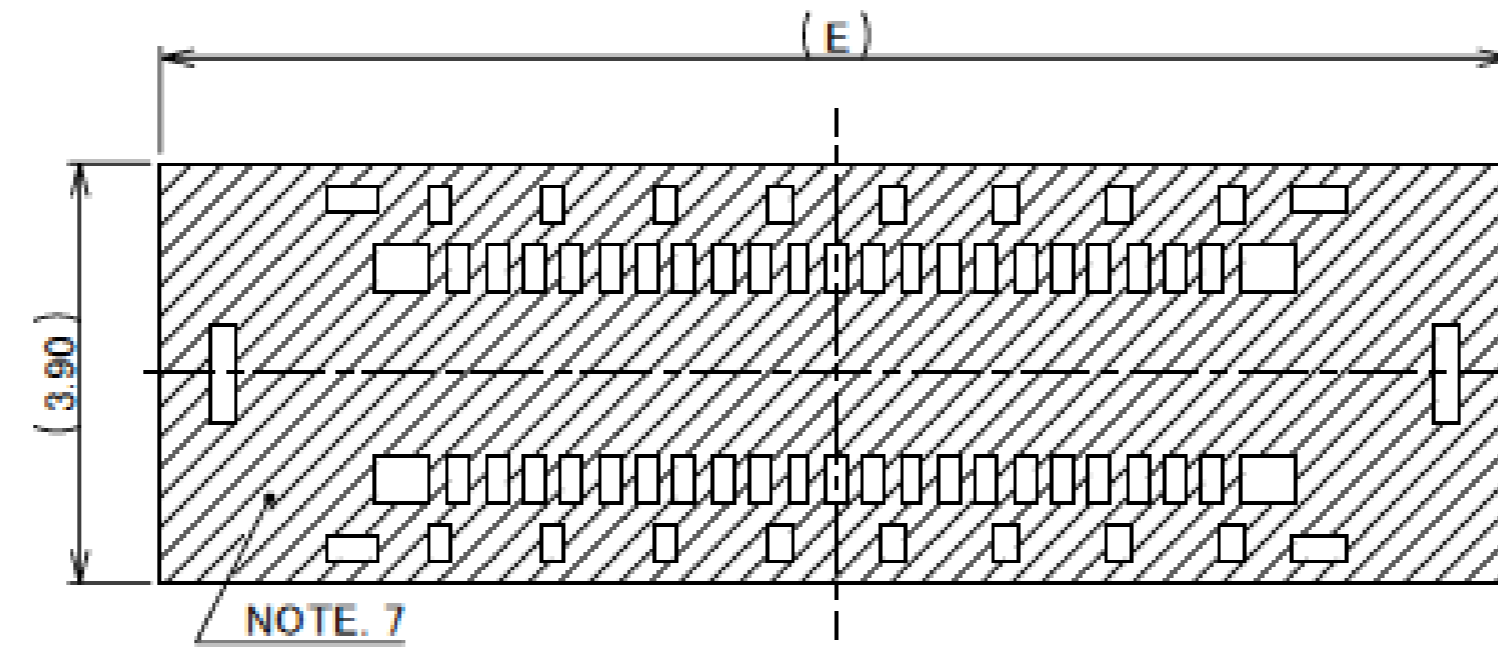

NOTES  
7. DO NOT MOUNT ANOTHER COMPONENT IN THIS AREA.

Rev.12

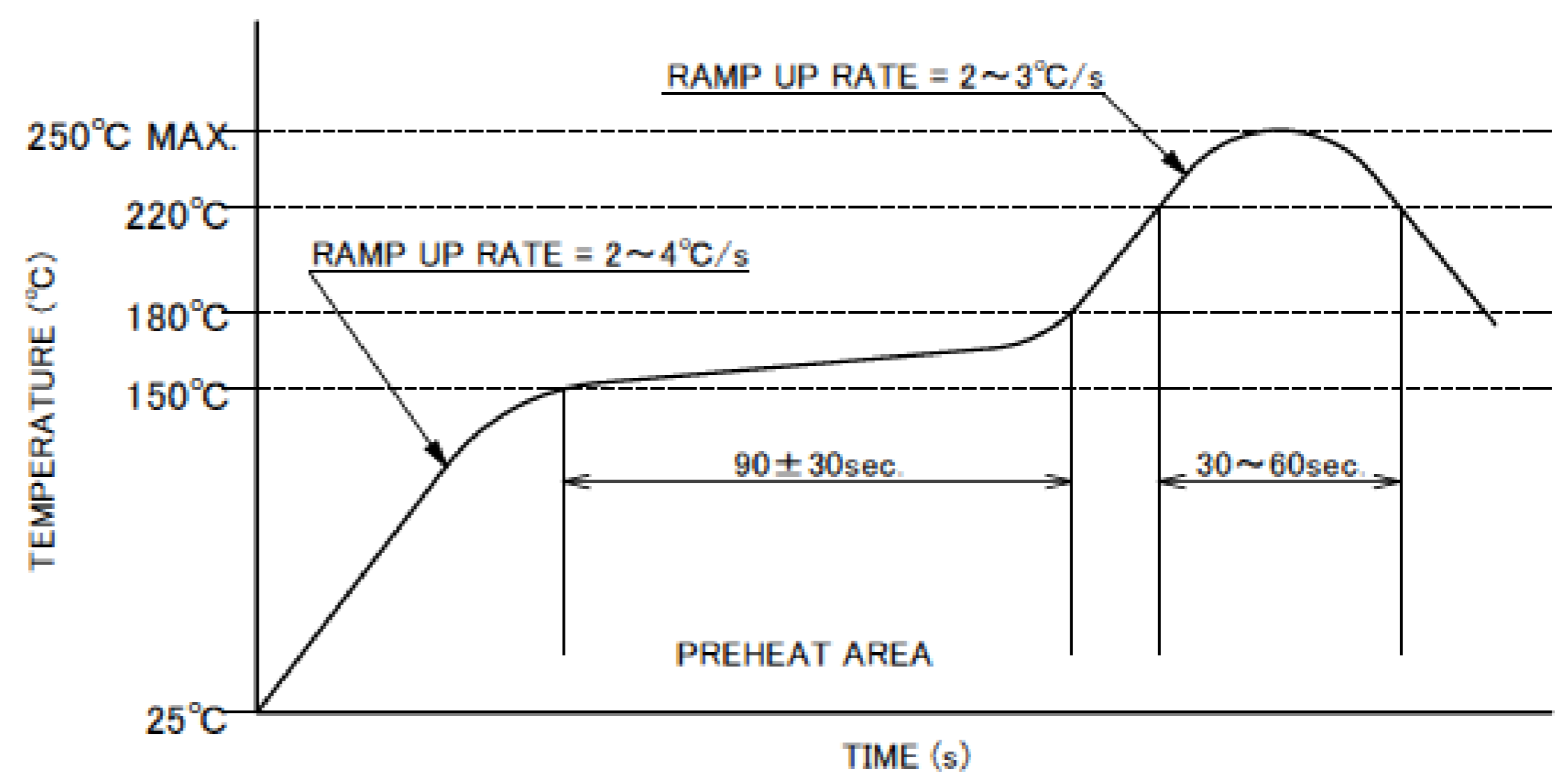
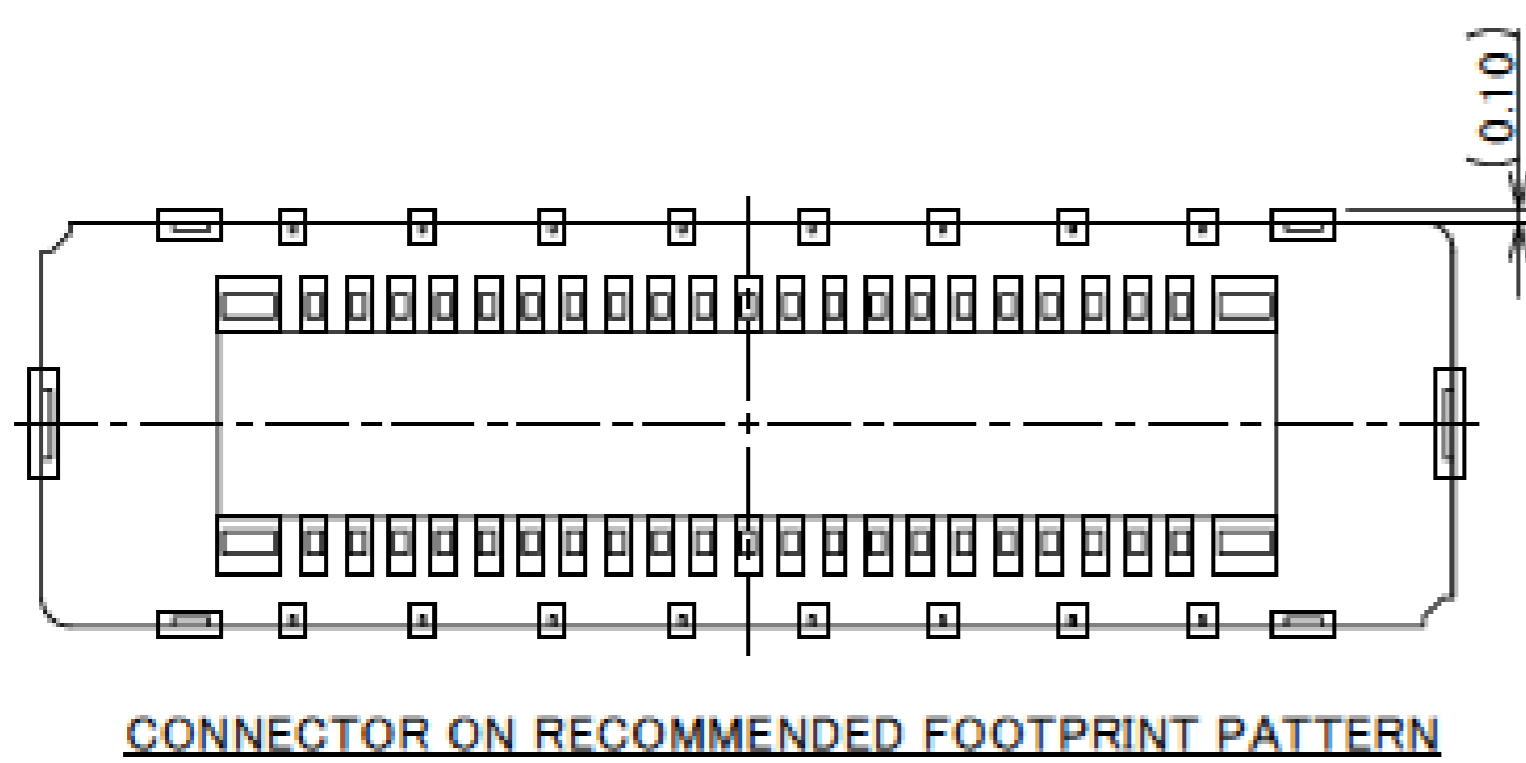

REFLOW TEMPERATURE PROFILE  
SENJU METAL INDUSTRY CO., LTD · M705-SHF(Sn96.5 Ag3.0 Cu0.5)

Rev.12

# Receptacle Assembly

ITEMS	SPECIFICATION
APPLICABLE CONNECTOR PART No.	20697-0**E-01*-*
RATING VOLTAGE	60V AC (PER CONTACT PIN)
RATING AMPERAGE (FOR SIGNAL CONTACT)	0.3A AC/DC (PER CONTACT PIN)/ 12.0A AC/DC(TOTAL)
RATING AMPERAGE (FOR POWER CONTACT)	2.2A AC/DC (PER CONTACT PIN)/ 8.8A AC/DC(TOTAL)
OPERATING TEMPERATURE	233~358K(-40°C~+85°C)
OPERATING HUMIDITY	85% MAX.(NON-CONDENSING)
CONTACT RESISTANCE (FOR SIGNAL CONTACT)	INITIAL : 40mohm MAX. / AFTER TEST : $\triangle$ 40mohm MAX.
CONTACT RESISTANCE (FOR POWER CONTACT)	INITIAL : 20mohm MAX. / AFTER TEST : $\triangle$ 20mohm MAX.
CONTACT RESISTANCE (FOR GROUND)	INITIAL : 20mohm MAX. / AFTER TEST : $\triangle$ 20mohm MAX.
INSULATION RESISTANCE	INITIAL : 1,000Mohm MIN. / AFTER TEST : 500Mohm MIN.
DIELECTRIC WITHSTANDING VOLTAGE	AC250V 1min
DURABILITY	30 CYCLES
MATING FORCE (INITIAL)	16P : 32.0N MAX. 28P : 32.0N MAX. 34P : 38.0N MAX. 42P : 46.0N MAX. 56P : 60.0N MAX. 62P : 66.0N MAX.
UNMATING FORCE (AFTER TEST)	16P : 3.2N MIN. 28P : 3.2N MIN. 34P : 3.8N MIN. 42P : 4.6N MIN. 56P : 6.0N MIN. 62P : 6.6N MIN.
COPLANARITY	0.08 MAX.
PRODUCT SPECIFICATION	PRS-2187
TEST REPORT	TR-16014
PACKING STANDARD	PST-15084 (10K/REEL) PST-16126 (5K/REEL)
INSTRUCTION MANUAL	HIM-15020
APPEARANCE CRITERIA No.	QLS-A***

Rev.12

# Custom Products Available

## RF Connector

MHF® series



## Micro-coaxial/Twinax/ Discrete Wire Connector

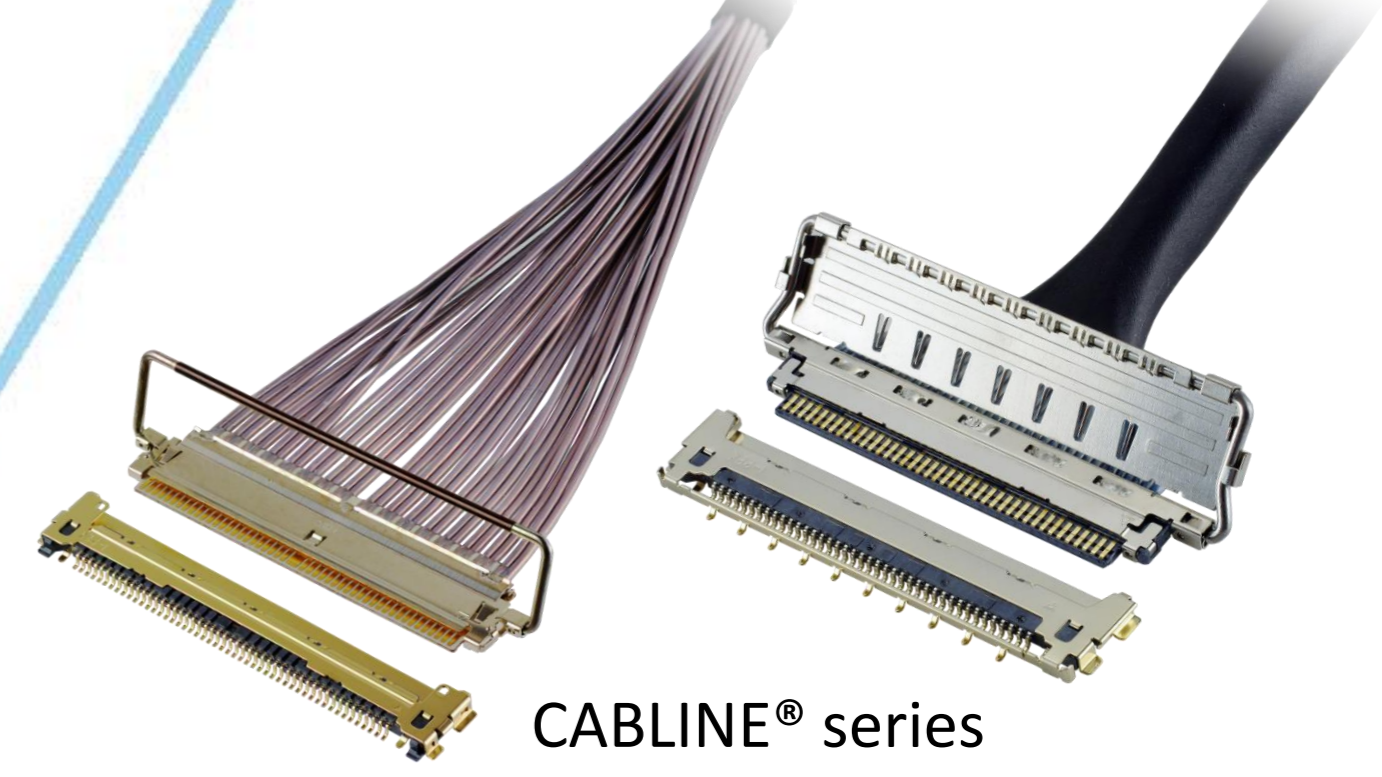

CABLINE® series



## Optical Module

LIGHTPASS® series



NOVASTACK® series

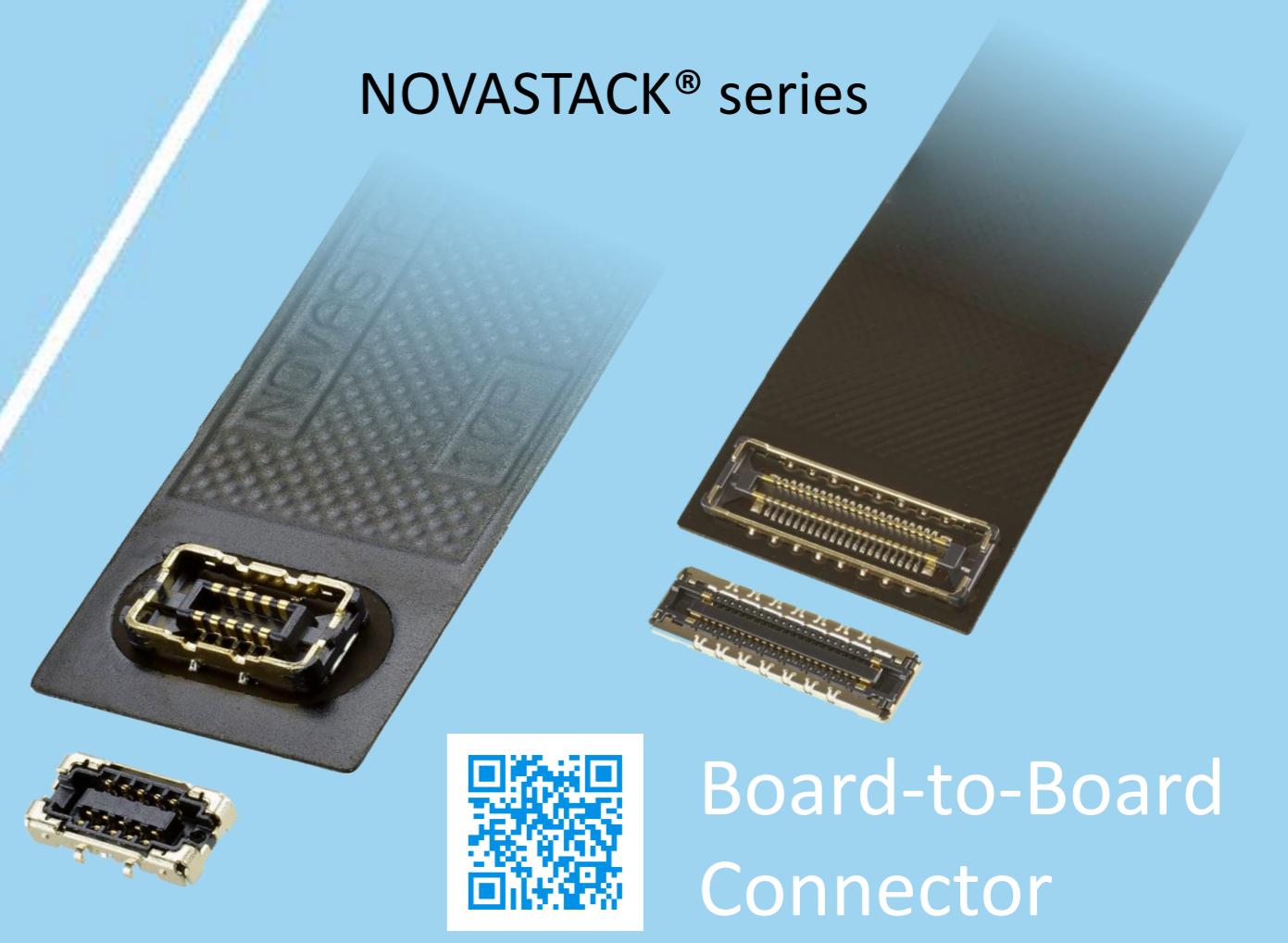

## Board-to-Board Connector



## Power Connector/ Terminal

AP series

ISH® series



MINIFLEX® series

EVAFLEX® series



## FPC FFC Connector



Inquiry



MINIDOCK® series

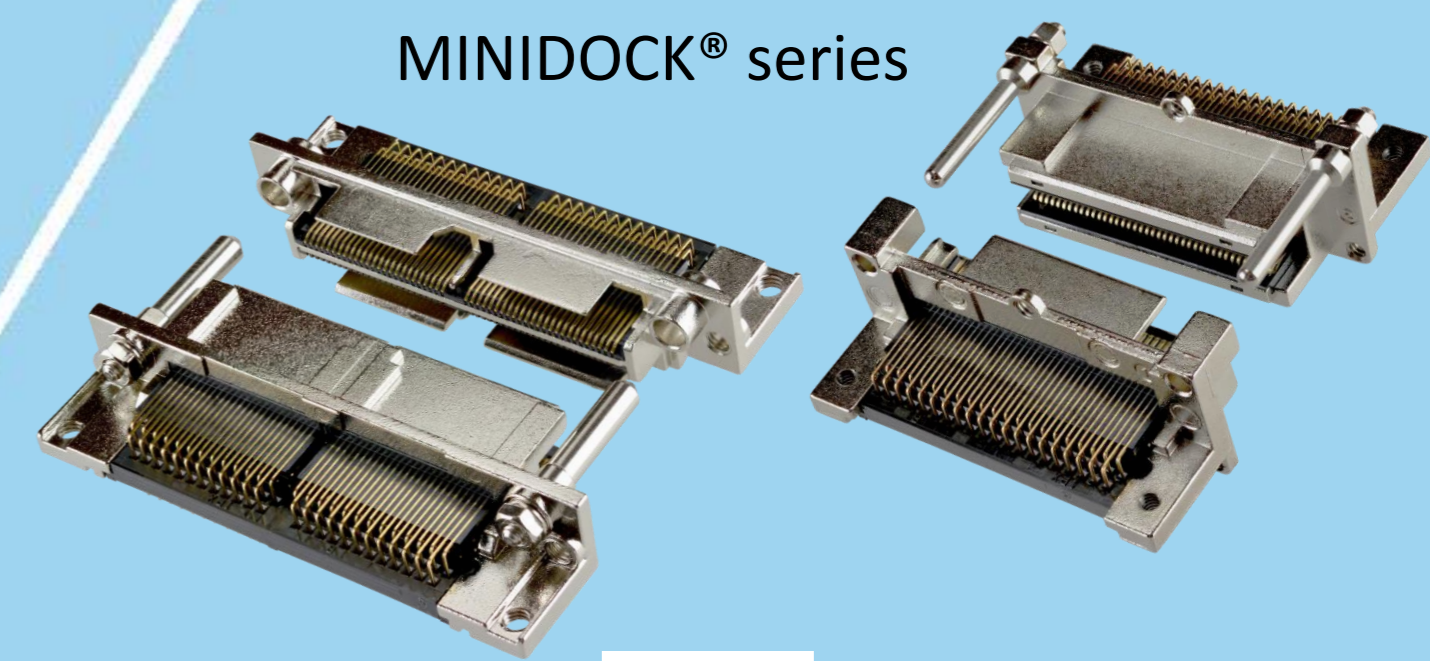

## I/O Connector

I-PEX, MHF, CABLINE, LIGHTPASS, NOVASTACK, ISH, IARPB, MINIFLEX, EVAFLEX, MINIDOCKS and ZenShield are registered trademarks of I-PEX Inc. Please note that the contents in the catalog might be changed without prior notification. I-PEX Inc. assumes no responsibility for any inaccuracies or obligation to update information on these documents. Please be sure to read and understand the latest "Precautions for Use" and "Instruction Manual" before you use our products. We shall not be responsible for any defects, damages or troubles in case you use our products without following the precautions for use. Please feel free to contact our sales representatives when you use our products for any applications that require very high reliability and safety, or that relate to human life (ex. nuclear power control, aerospace, transportation, medical equipment, safety equipment etc.).

Contact your sales representative or more detailed information.

[www.i-pex.com](http://www.i-pex.com)



# I-PEX

© I-PEX Inc. 2024  
All rights reserved