

# SMA-A0204FTDX120K ✓ ACTIVE

Neohm | Neohm SMA-A

TE Internal #: 8-2176315-7

120K ohm, Surface Mount Precision Resistor, Thin Film, 0204, .4 W,

1 %, ±50 ppm/°C, Metal Electrode Leadless Face (MELF), 2

Terminations, Neohm SMA-A

[View on TE.com >](#)



Passive Components > Resistors > Surface Mount Resistors



Resistance Value: 120K  $\Omega$

Resistor Type: Precision Resistor

Element Type: Thin Film

Package Size Code: 0204

Power Rating: .4 W

## Features

### Dimensions

Product Diameter	1.4 mm[.055 in]
Product Length	3.5 mm[.138 in]

### Usage Conditions

Operating Temperature Range	-55 – 155 °C
Temperature Coefficient	±50 ppm/°C

### Electrical Characteristics

Operating Voltage	200 V
Resistance Value	120K $\Omega$
Power Rating	.4 W
Resistance Class	1k $\Omega$ – 1M $\Omega$
Passive Component Tolerance	1 %

### Product Type Features

Resistor Type	Precision Resistor
Element Type	Thin Film



Package Size Code	0204
-------------------	------

### Configuration Features

Number of Resistors	1
---------------------	---

### Termination Features

Surface Mount Resistor Termination Type	Metal Electrode Leadless Face (MELF)
---	--------------------------------------

Number of Terminations	2
------------------------	---

### Packaging Features

Packaging Method	Taped & Reeled
------------------	----------------

### Other

EU RoHS Compliance	Compliant
--------------------	-----------

EU ELV Compliance	Compliant
-------------------	-----------

## Product Compliance

[For compliance documentation, visit the product page on TE.com>](#)

EU RoHS Directive 2011/65/EU	Compliant
------------------------------	-----------

EU ELV Directive 2000/53/EC	Compliant
-----------------------------	-----------

China RoHS 2 Directive MIIT Order No 32, 2016	No Restricted Materials Above Threshold
---	---

EU REACH Regulation (EC) No. 1907/2006	Current ECHA Candidate List: JUNE 2024 (241) Candidate List Declared Against: JUNE 2024 (241) Does not contain REACH SVHC
--	---

Halogen Content	Low Halogen - Br, Cl, F, I < 900 ppm per homogenous material. Also BFR/CFR/PVC Free
-----------------	---

Solder Process Capability	Reflow solder capable to 260°C
---------------------------	--------------------------------

#### Product Compliance Disclaimer

This information is provided based on reasonable inquiry of our suppliers and represents our current actual knowledge based on the information they provided. This information is subject to change. The part numbers that TE has identified as EU RoHS compliant have a maximum concentration of 0.1% by weight in homogenous materials for lead, hexavalent chromium, mercury, PBB, PBDE, DBP, BBP, DEHP, DIBP, and 0.01% for cadmium, or qualify for an exemption to these limits as defined in the Annexes of Directive 2011/65/EU (RoHS2). Finished electrical and electronic equipment products will be CE marked as required by Directive 2011/65/EU. Components may not be CE marked. Additionally, the part numbers that TE has identified as EU ELV compliant have a maximum concentration of 0.1% by weight in homogenous materials for lead, hexavalent chromium, and mercury, and 0.01% for cadmium, or qualify for an exemption to these limits as defined in the Annexes of Directive 2000/53/EC (ELV). Regarding the REACH Regulation, the information TE provides on SVHC in articles for this part number is based on the latest European Chemicals Agency (ECHA) 'Guidance on requirements for substances in articles' posted at this URL: <https://echa.europa.eu/guidance-documents/guidance-on-reach>

## Compatible Parts

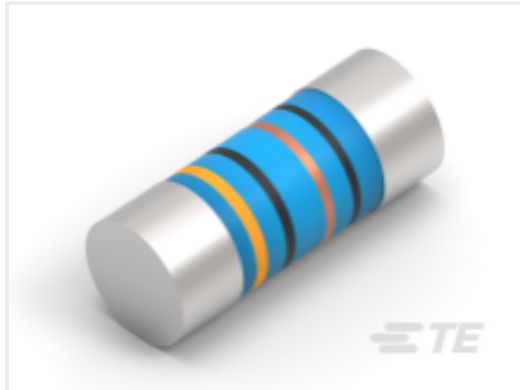

TE Part # 9-2176316-4  
MELF SMA-A 330K 1% 50PPM 0207 1W

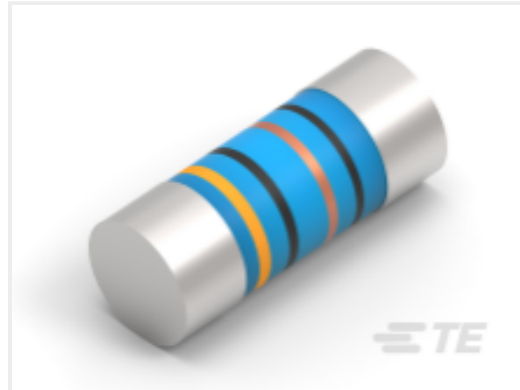

TE Part # 3-2176315-2  
MELF SMA\_A 39K 0.1% 15PPM 0204 0.4W

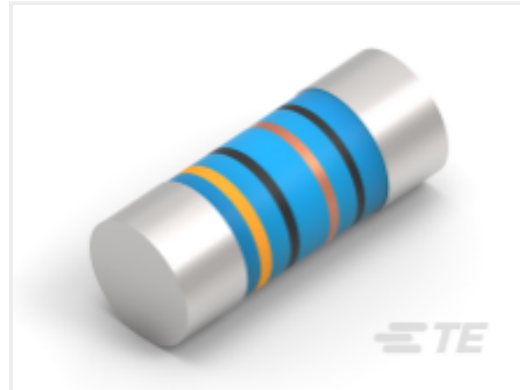

TE Part # 9-2176315-8  
MELF SMA-A 1M0 1% 50PPM 0204 0.4 W

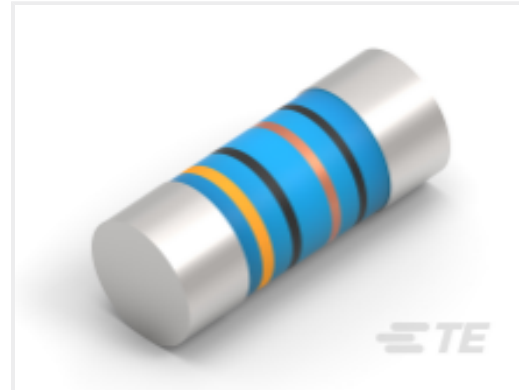

TE Part # 2176316-5  
MELF SMA\_A 220R 0.1% 15PPM 0207 1W

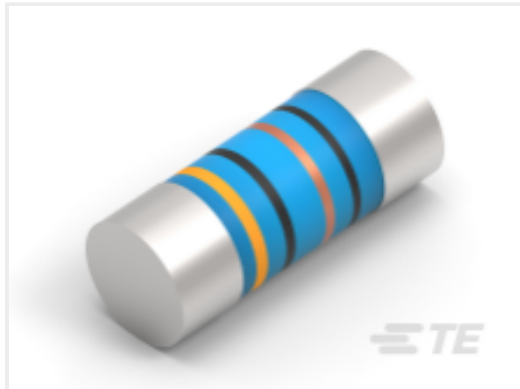

TE Part # 6-2176314-9  
MELF SMA-A 10R 1% 50PPM 0102 0.3 W

## Also in the Series | [Neohm SMA-A](#)



[Surface Mount Resistors\(270\)](#)

## Customers Also Bought



TE Part #5-1623932-5  
CFR50 5% 200R

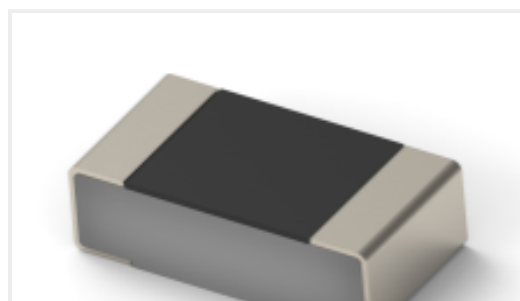

TE Part #1-2176467-1  
TLRP 1206 1.0W R005 1% 75PPM 5K RL

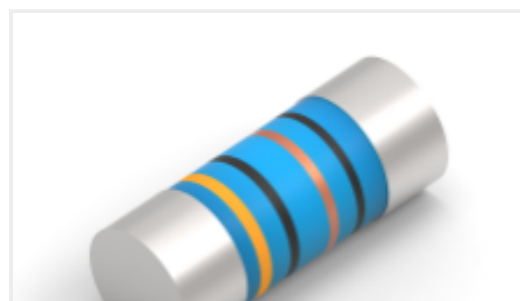

TE Part #7-2176315-0  
MELF SMA\_A 47K 1% 50PPM 0204 0.4 W



TE Part #1623930-2  
CFR25 5% 100R

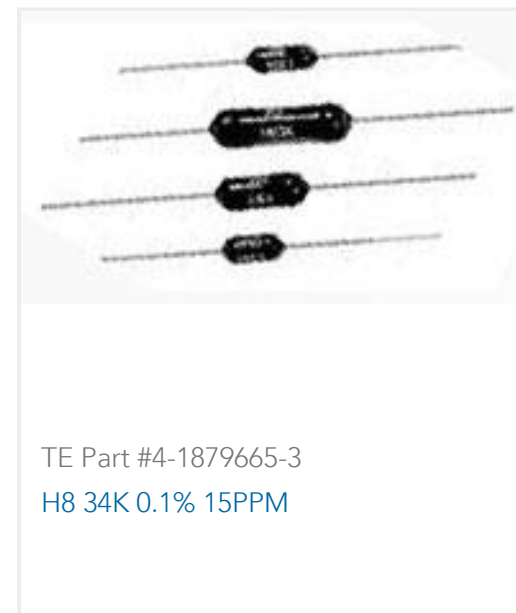
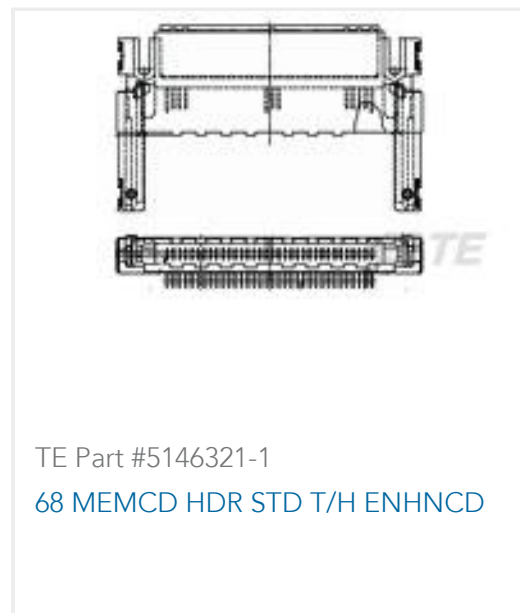

## Documents

### Product Drawings

[MELF SMA-A 120K 1% 50PPM 0204 0.4W](#)

English

### CAD Files

[3D PDF](#)

3D

Customer View Model

[ENG\\_CVM\\_CVM\\_8-2176315-7\\_BA.2d\\_dxf.zip](#)

English

Customer View Model

[ENG\\_CVM\\_CVM\\_8-2176315-7\\_BA.3d\\_igs.zip](#)

English

Customer View Model

[ENG\\_CVM\\_CVM\\_8-2176315-7\\_BA.3d\\_stp.zip](#)

English

By downloading the CAD file I accept and agree to the [Terms and Conditions](#) of use.

### Datasheets & Catalog Pages

[SMA-A-1017](#)

English