

Specification Sheet

Part Number: 151-01492

One-piece ratchet closure design allows for easy installation during pre- or final assembly.

Four sizes and multiple configurations handle a wide range of diameters and applications, reducing part inventory.

Clamp interior is designed to guide and center bundle to reduce pinching.

Easy release feature allows for quick adjustments and maintenance.

Impact modified, heat and UV stabilized PA66 provides long-term durability, indoors and out.

Soft material inserts are available for sensitive bundles.

For pre-determined clamp pressure, a Tension Tab is available for use with our EVO Series hand tools.

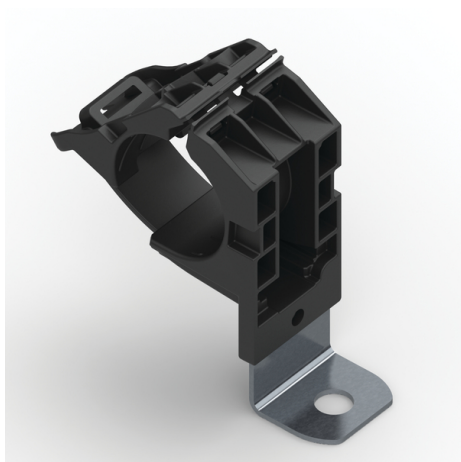

Ratchet P-Clamp, 0.76 - 1.42" Bundle Dia, 90° Short, 0.33" Hole Dia, PA66HIRHSUV/ST/ZN, Black, 160/ctn

Article Number	151-01492
Type	RCC90SM8
Color	Black (BK)
Quantity Per	box

Product Description	Ratchet P-Clamp, 0.76 - 1.42" Bundle Dia, 90° Short, 0.33" Hole Dia, PA66HIRHSUV/ST/ZN, Black, 160/ctn
Short Description	Ratchet P-Clamp, 0.76 - 1.42" Bundle Dia, 90° Short, 0.33" Hole Dia, PA66HIRHSUV/ST/ZN, Black, 160/ctn
Global Part Name	RCC90SM8-PA66HIRHSUV/ST/ZN-BK
Minimum Tensile Strength (Imperial)	100
Minimum Tensile Strength (Metric)	445
Length L (Imperial)	5.58
Length L (Metric)	141.8
Fixation Method	Screw Mounting
Variant	Short
Width W (Imperial)	1.37
Width W (Metric)	34.9
Bundle Diameter Min (Imperial)	0.76
Bundle Diameter Min (Metric)	19.4
Bundle Diameter Max (Imperial)	1.42
Bundle Diameter Max (Metric)	36.0

Cable Tie Width Max (Imperial)	0.52
Cable Tie Width Max (Metric)	13.2
Mounting Hole Diameter D (Imperial)	0.327
Mounting Hole Diameter D (Metric)	8.31 mm
Mounting Hole Diameter D Max (Metric)	8.31
Stud Diameter (Metric)	M8
Mounting Hole Centers (Imperial)	1.57
Material	Zinc plated (ZN) Polyamide 6.6 high impact modified, heat and UV stabilized (PA66HIRHSUV) Steel (ST)
Material Shortcut	ST ZN PA66HIRHSUV
Flammability	UL 94 HB
Halogen Free	Yes
UV Resistant (Yes/No)	Yes
Use Conditions	For Indoor and Outdoor Use
Plenum Rating	AH-2
Operating Temperature	-40°F to +221°F (-40°C to +105°C)

Reach Compliant (Article 33)	Yes
ROHS Compliant	Yes
UL Listed (US and Canada)	Yes
UL Listed (US)	Yes
Package Quantity (Imperial)	160
Package Quantity (Metric)	160
Customs Number	3926909988

© 2025 HellermannTyton. All Rights Reserved.

[Contact Us](#)

[RoHS/WEEE Compliance](#)

[Disclaimer](#)

[Terms and Conditions](#)