

Click to
ORDER
samples

AMEL20-277HAVZ



Encapsulated

The AMEL20-277HAVZ series is an efficient 20W AC-DC power supply module. Offering a commercial input voltage range of 85-305VAC, output voltage ranges from 3.3-24V, low power consumption, high efficiency, high reliability and safer isolation.

This new series offers great operating temperatures, from -40°C to 85°C with full power up to 50°C and features an isolation of 4000VAC for improved reliability and system safety. Furthermore, a high MTBF of 285,000h, output short circuit protection (OSCP), output over-current protection (OCP) and an output over-voltage protection (OVP) come standard with the series.

The AMEL20-277HAVZ is suitable for grid power, industrial instrumentation and controls, communication, and civil applications.

Features

- Universal Input: 85 - 305VAC/100 - 430VDC
- Operating Temp: -40 °C to +85 °C
- High isolation voltage: 4000VAC
- Low ripple & noise, 150mV(p-p), max.
- Output short circuit, over-current, over-voltage protection
- Low no-load power consumption of 0.1W
- Efficiency up to 87%
- Agency approvals: IEC/EN/UL62368-1, EN60335, EN61558

Summary

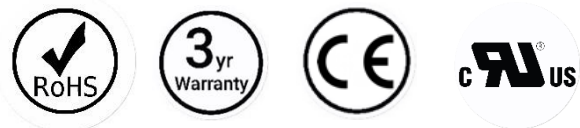
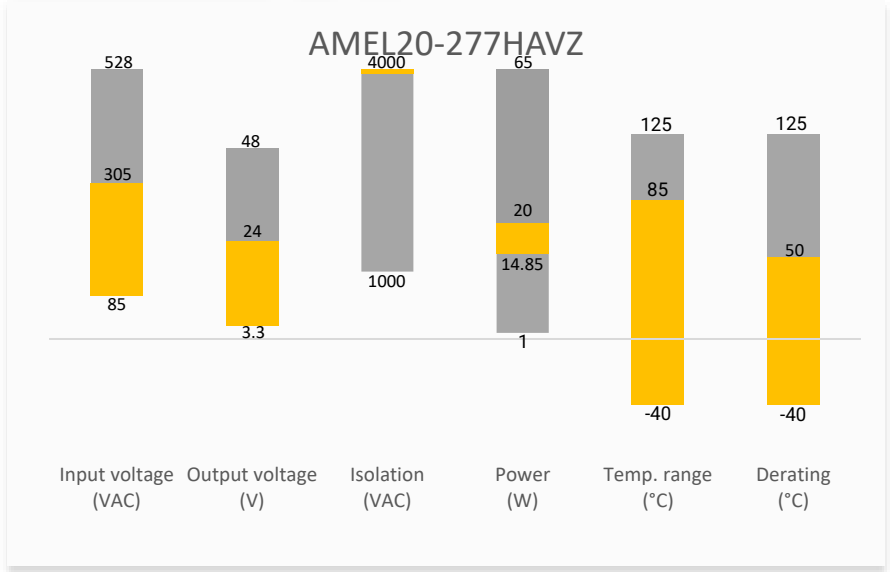

Training



Product Training Video
(click to open)

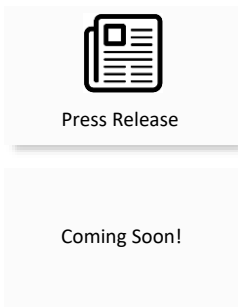

Application Notes

Applications

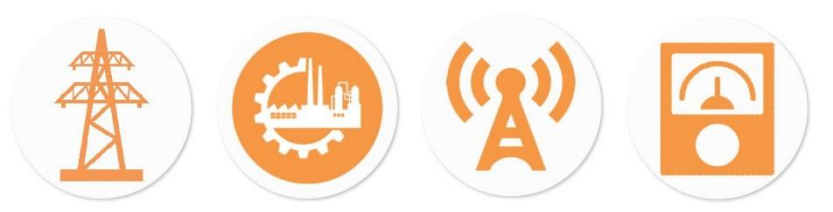

Power Grid

Industrial

Telecom

Instrumentation

Models & Specifications

Single Output

Model	Input Voltage (VAC/Hz)	Input Voltage (VDC)	Max Output wattage (W)	Output Voltage (V)	Output Current max (A)	Maximum capacitive load (μ F)	Efficiency @ 230VAC Typ. (%)
AMEL20-3S277HAVZ	85-305/47-63	100-430	14.85	3.3	4.5	8000	81
AMEL20-5S277HAVZ	85-305/47-63	100-430	20	5	4	8000	85
AMEL20-9S277HAVZ	85-305/47-63	100-430	20	9	2.2	3500	85
AMEL20-12S277HAVZ	85-305/47-63	100-430	20	12	1.67	2500	86
AMEL20-15S277HAVZ	85-305/47-63	100-430	20	15	1.33	2200	87
AMEL20-24S277HAVZ	85-305/47-63	100-430	20	24	0.83	820	87

Input Specifications

Parameters	Conditions	Typical	Maximum	Units
Input current	115VAC		500	mA
	230VAC		300	mA
Inrush current	115VAC	20		A
	230VAC	45		A
Leakage	277VAC, 50Hz		0.1	mA RMS
Fuse	2A/300V, Slow blow			

Output Specifications

Parameters	Conditions	Typical	Maximum	Units
Voltage accuracy		± 1.5		%
Line regulation	Full load	± 0.5		%
Load regulation	0-100% load	± 1		%
Ripple & Noise*	20MHz bandwidth	100	150	mV p-p
Hold up time	115VAC	8		ms
	230VAC	50		ms

* Ripple and Noise are measured at 20MHz bandwidth with a 10 μ F electrolytic capacitor and a 1 μ F ceramic capacitor. Please refer to the application note for specific details.

Isolation Specification

Parameters	Conditions	Typical	Maximum	Units
Tested I/O voltage	60 sec, leakage \leq 5mA	4000		VAC
Resistance	500VDC	>100		M Ω

General Specifications

Parameters	Conditions	Typical	Maximum	Units
Protection class	Class II			
Over current protection	Auto recovery	≥ 110		% of Iout

Over voltage protection	3.3, 5Vout, voltage clamp, hiccup		7.5	VDC
	9Vout, voltage clamp, hiccup		16	VDC
	12, 15Vout, voltage clamp, hiccup		20	VDC
	24Vout, voltage clamp, hiccup		30	VDC
Short circuit protection	Hiccup, Continuous, Auto recovery			
Switching Frequency		65		KHz
Operating altitude			5000	m
Operating temperature	See derating graph	-40 to +85		°C
Storage temperature		-40 to +85		°C
Reflow soldering temperature	Duration 5 - 10s	260		°C
Manual soldering temperature	Duration 3 - 5s	360		°C
No-load power consumption	230VAC, 24Vout	0.12		W
	230VAC, others	0.1		W
Power Derating	-40 °C to -25 °C, 85VAC to 165VAC	2.0		%/°C
	+50 °C to +70 °C, 3.3/5/9Vout	2.5		%/°C
	+55 °C to +70 °C, 12/15/24Vout	3.33		%/°C
	+70 °C to +85 °C	1.33		%/°C
	85VAC to 100VAC	2.0		%/VAC
	277VAC to 305VAC	0.71		%/VAC
Temperature coefficient	2000 - 5000m	6.7		%/km
Cooling	Free air convection			
Humidity	Non-condensing	>10	95	% RH
Case material	Plastic (flammability to UL 94V-0)			
Weight		55		g
Dimensions (L x W x H)	2.06 x 1.07 x 0.94 inches (52.40 x 27.20 x 24.00 mm)			
MTBF	> 285 000 hrs (MIL-HDBK -217F, t=+25°C)			

NOTE: All specifications in this datasheet are measured at an ambient temperature of 25°C, humidity<75%, nominal input voltage and at rated output load unless otherwise specified.

Safety Specifications

Parameters

Agency Approvals	IEC/EN/UL 62368-1, EN60335, EN61558	
Standards	EMC - Conducted and radiated emission	CISPR32 / EN55032, class B with no external circuit
	Electrostatic Discharge Immunity	IEC 61000-4-2 Contact ±6KV, Air ±8KV, Criteria A
	RF, Electromagnetic Field Immunity	IEC 61000-4-3 10V/m, Criteria A
	Electrical Fast Transient/Burst Immunity	IEC 61000-4-4 ±2KV, Criteria A
	Surge Immunity	IEC 61000-4-5 L-L ±1KV, Criteria A
	RF, Conducted Disturbance Immunity	IEC 61000-4-6 10Vr.m.s, Criteria A
	Power Frequency Magnetic Field Immunity	IEC 61000-4-8 10A/m, Criteria A
Voltage dips, Short Interruptions Immunity	IEC 61000-4-11 0%, 70%, Criteria B	

Derating

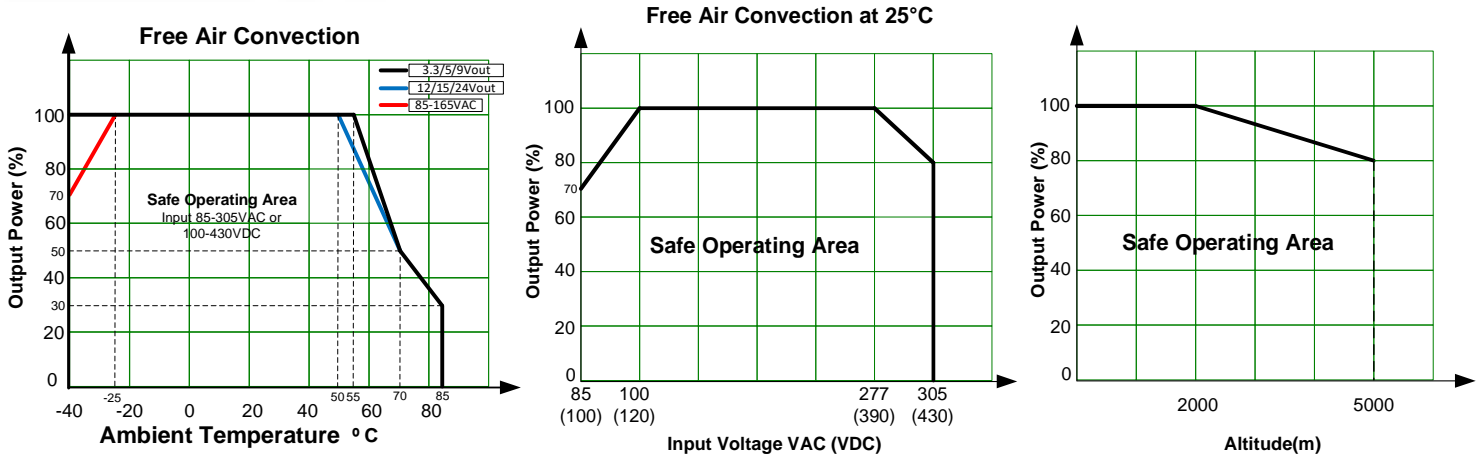

Typical Application Circuit

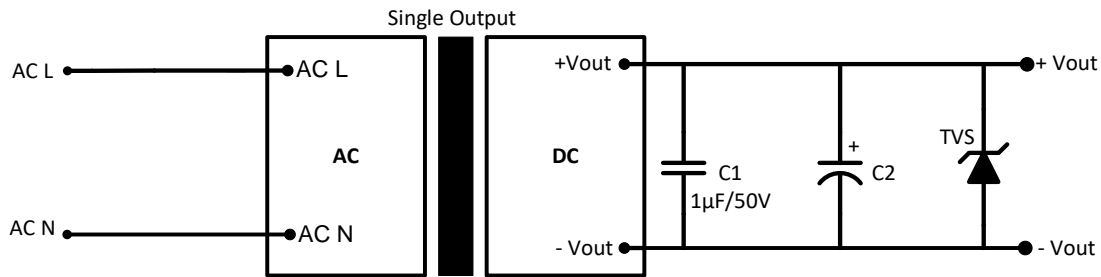

Model	C2	TVS
3.3, 5Vout	10µF/16V	7V
9Vout	10µF/25V	12V
12, 15Vout	10µF/25V	20V
24Vout	10µF/35V	30V

For filtering components:

The C2 capacitor is recommended to use electrolytic type with high frequency and low ESR rating. The C1 capacitor is recommended to use ceramic type for filtering high-frequency noise.

Dimensions

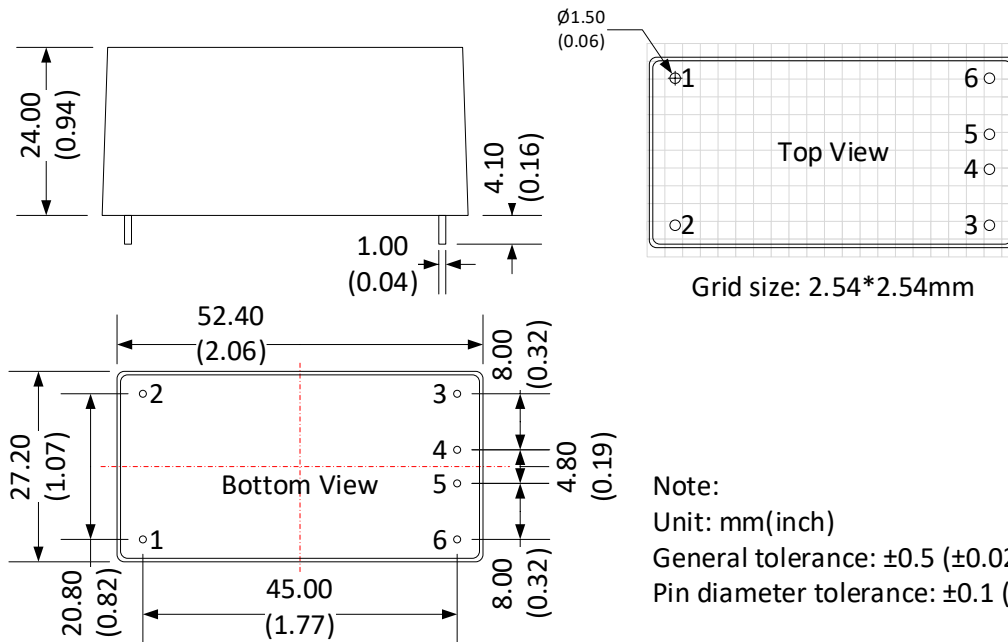

Pin Output Specifications	
Pin	Function
1	AC Input (L)
2	AC Input (N)
3	-V Output
4	+V Output
5	No Pin
6	No Pin

NOTE: 1. Datasheets are updated as needed and as such, specifications are subject to change without notice. Once printed or downloaded, datasheets are no longer controlled by Aimtec; refer to www.aimtec.com for the most current product specifications. 2. Product labels shown, including safety agency certifications on labels, may vary based on the date manufactured. 3. Mechanical drawings and specifications are for reference only. 4. All specifications are measured at an ambient temperature of 25°C, humidity<75%, nominal input voltage and at rated output load unless otherwise specified. 5. Aimtec may not have conducted destructive testing or chemical analysis on all internal components and chemicals at the time of publishing this document. CAS numbers and other limited information are considered proprietary and may not be available for release. 6. This product is not designed for use in critical life support systems, equipment used in hazardous environments, nuclear control systems or other such applications which necessitate specific safety and regulatory standards other the ones listed in this datasheet. 7. Warranty is in accordance with Aimtec's standard Terms of Sale available at www.aimtec.com.