

CRYSTAL-RS

~5.1° spot beam. Assembly with holder.

SPECIFICATION:

Dimensions	Ø 49.7
Height	28.7 mm
Fastening	pin, screw
ROHS compliant	yes ⓘ

MATERIALS:

Component	Type	Material	Colour	Finish	Length (mm)
F12916_CRYSTAL-RS	Single lens	PMMA	clear		
C13478_CRYSTAL-HLD	Holder	PC	white		

ORDERING INFORMATION:

Quantities for one set:

Single lens	1
Holder	1



Component		Qty in box	MOQ	MPQ	Box weight (kg)
F12916_CRYSTAL-RS	Single lens	288	64	32	8.6
» Box size: 480 x 280 x 300 mm					
C13478_CRYSTAL-HLD	Holder	1152	64	32	6.1
» Box size: 480 x 280 x 300 mm					

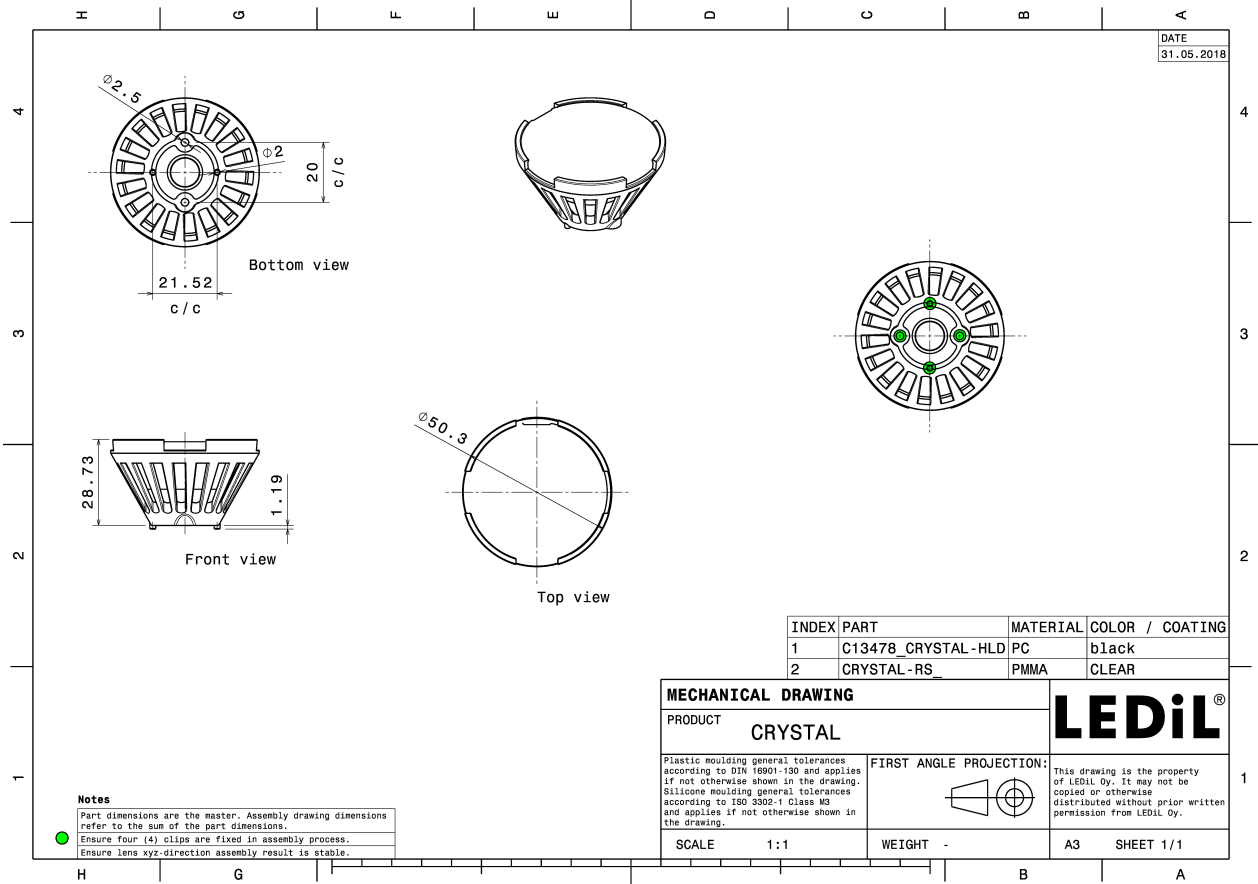

See also our general installation guide: www.ledil.com/installation_guide

OPTICAL RESULTS (MEASURED):



LED XHP35 HI
FWHM / FWTM 5.7° / 15.0°
Efficiency 89 %
Peak intensity 48.3 cd/lm
LEDs/each optic 1
Light colour/type White
Required components:

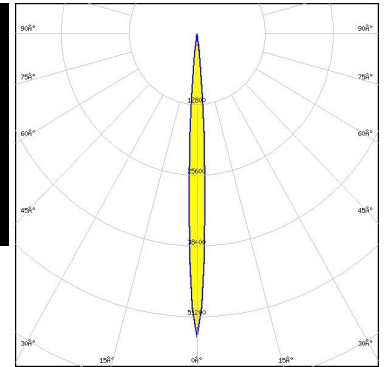
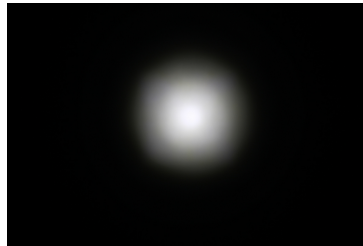

Light distribution files



LED XHP50
FWHM / FWTM 11.0° / 24.0°
Efficiency 93 %
Peak intensity 14.1 cd/lm
LEDs/each optic 1
Light colour/type White
Required components:

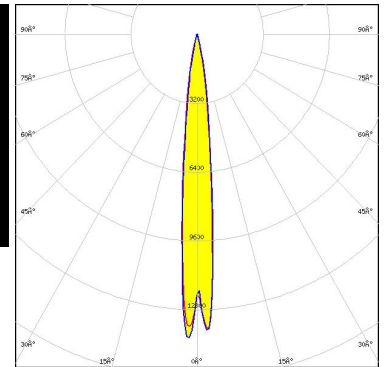

Light distribution files



LED XM-L
FWHM / FWTM 7.0° / 17.0°
Efficiency 94 %
Peak intensity 34.9 cd/lm
LEDs/each optic 1
Light colour/type White
Required components:

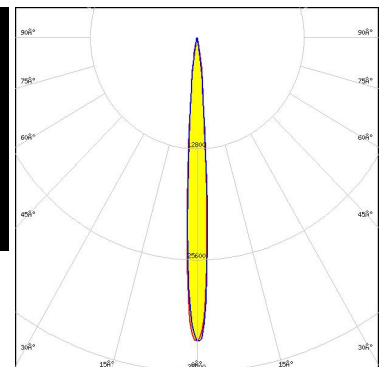

Light distribution files

OPTICAL RESULTS (MEASURED):



LED XP-G
 FWHM / FWTM 4.9° / 11.4°
 Efficiency 89 %
 Peak intensity 68.3 cd/lm
 LEDs/each optic 1
 Light colour/type White
 Required components:

Light distribution files



LED XP-L HD
 FWHM / FWTM 7.0° / 15.0°
 Efficiency 88 %
 Peak intensity 34.7 cd/lm
 LEDs/each optic 1
 Light colour/type White
 Required components:

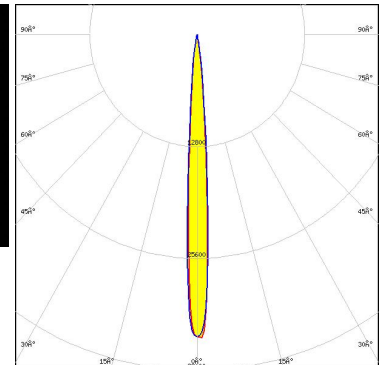

Light distribution files



LED LUXEON 3030 2D (Round LES)
 FWHM / FWTM 4.0° / 15.0°
 Efficiency 94 %
 Peak intensity 52.1 cd/lm
 LEDs/each optic 1
 Light colour/type White
 Required components:

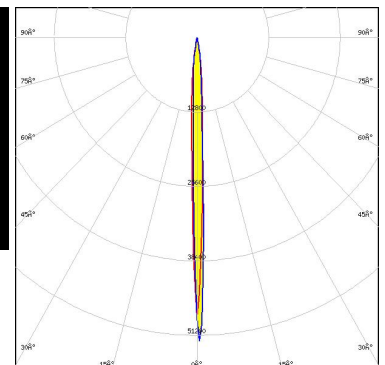
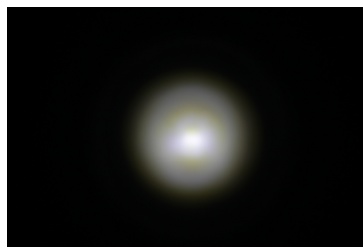

Light distribution files

OPTICAL RESULTS (MEASURED):



LED LUXEON 5050 Round LES
 FWHM / FWTM 9.0° / 24.0°
 Efficiency 94 %
 Peak intensity 17.8 cd/lm
 LEDs/each optic 1
 Light colour/type White
 Required components:

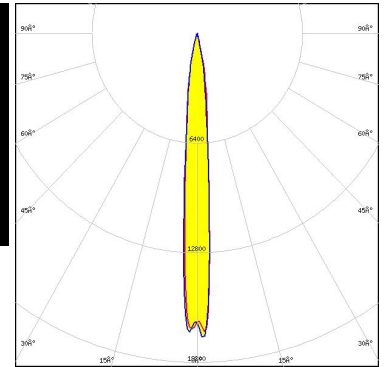
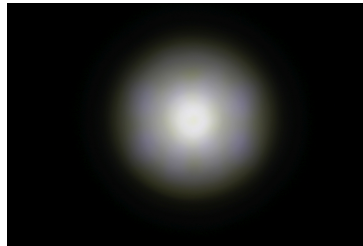

Light distribution files



LED LUXEON A
 FWHM / FWTM 5.1° / 14.0°
 Efficiency 89 %
 Peak intensity 58.9 cd/lm
 LEDs/each optic 1
 Light colour/type White
 Required components:



Light distribution files



LED LUXEON Z ES
 FWHM / FWTM 3.0° / 9.0°
 Efficiency 93 %
 Peak intensity 103.8 cd/lm
 LEDs/each optic 1
 Light colour/type White
 Required components:

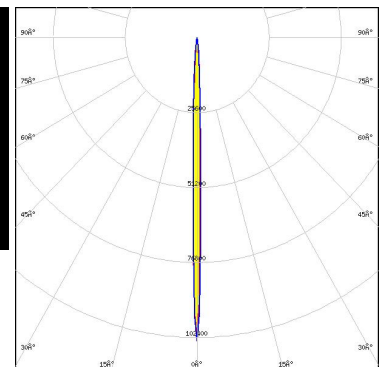
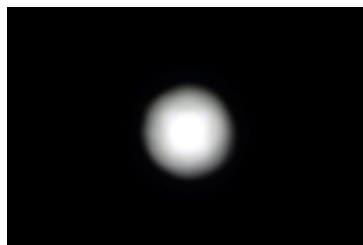

Light distribution files

OPTICAL RESULTS (MEASURED):



LED NV4x144A
 FWHM / FWTM 12.0° / 25.0°
 Efficiency 92 %
 Peak intensity 14.2 cd/lm
 LEDs/each optic 1
 Light colour/type White
 Required components:

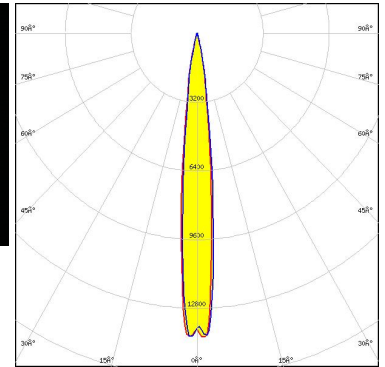

Light distribution files



LED NVSW3x9A
 FWHM / FWTM 6.0° / 16.0°
 Efficiency 89 %
 Peak intensity 36.5 cd/lm
 LEDs/each optic 1
 Light colour/type White
 Required components:

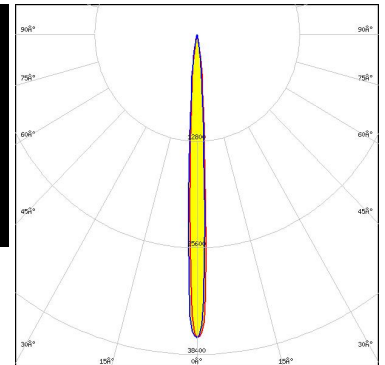
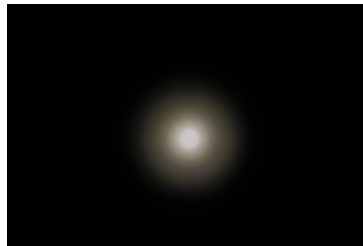

Light distribution files



LED NVSW719AC
 FWHM / FWTM 5.0° / 12.0°
 Efficiency 93 %
 Peak intensity 61 cd/lm
 LEDs/each optic 1
 Light colour/type White
 Required components:

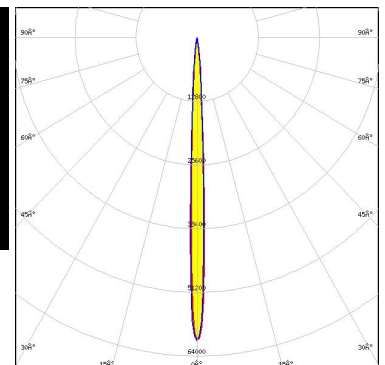

Light distribution files

OPTICAL RESULTS (MEASURED):

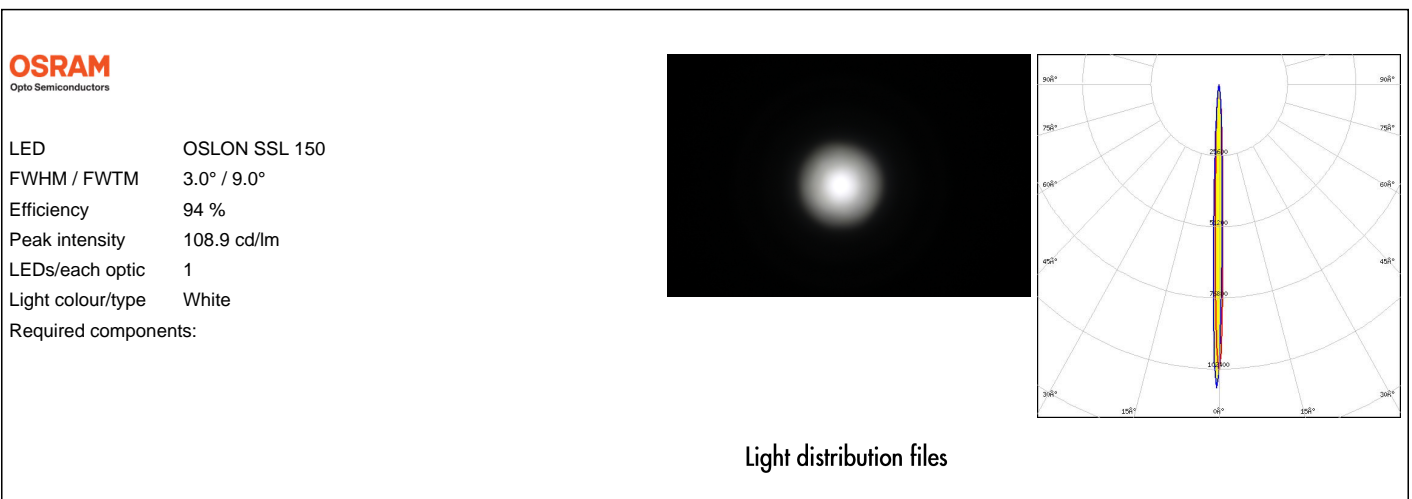
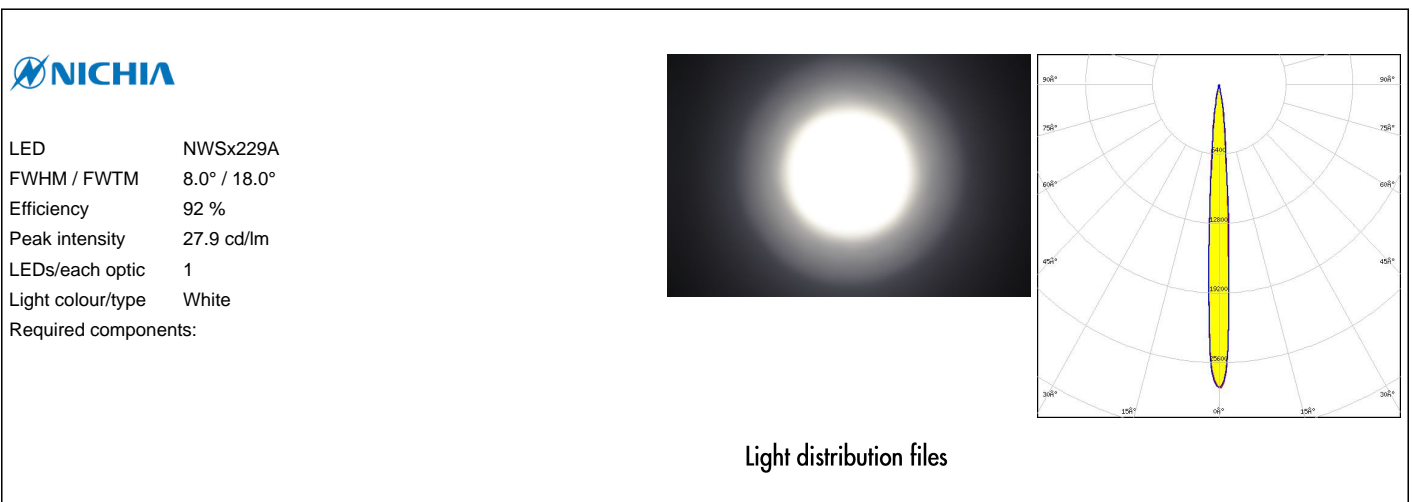
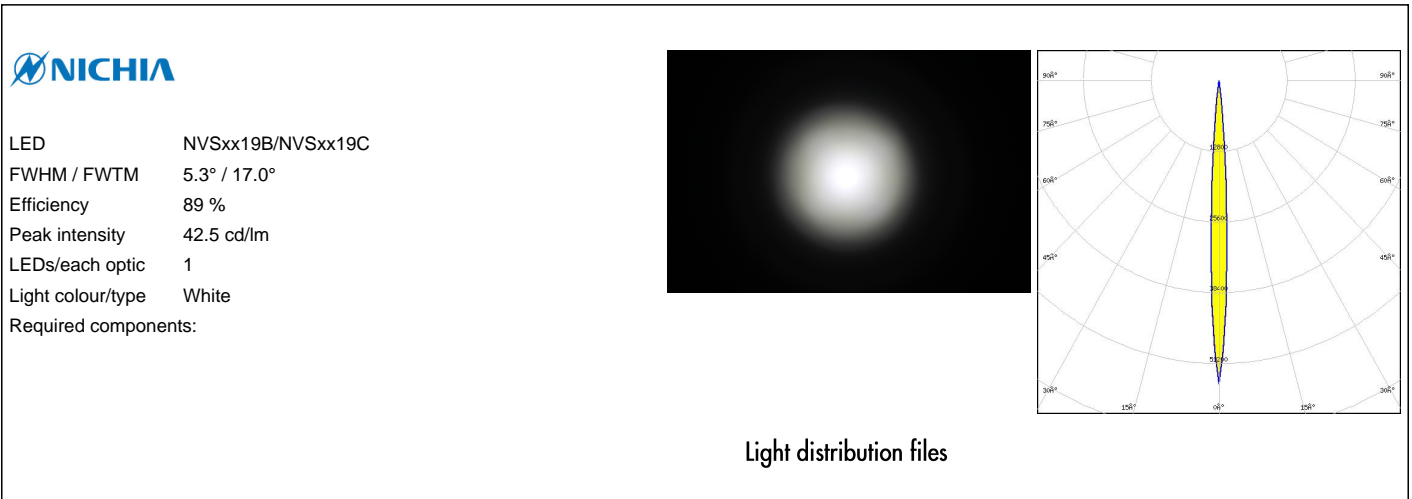

OPTICAL RESULTS (MEASURED):

SAMSUNG

LED LH351Z
 FWHM / FWTM 4.4° / 12.0°
 Efficiency 90 %
 Peak intensity 77 cd/lm
 LEDs/each optic 1
 Light colour/type White
 Required components:

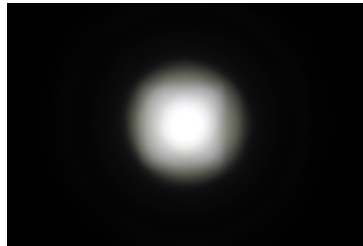

Light distribution files



SEOUL SEMICONDUCTOR

LED WICOP 5050
 FWHM / FWTM 12.0° / 25.0°
 Efficiency 92 %
 Peak intensity 13.3 cd/lm
 LEDs/each optic 1
 Light colour/type White
 Required components:

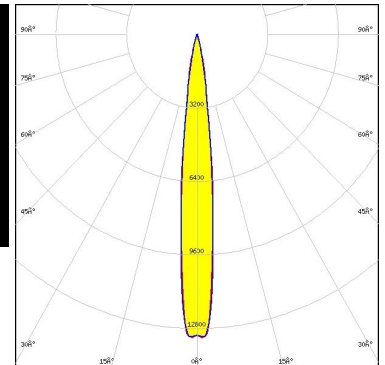

Light distribution files



SEOUL SEMICONDUCTOR

LED Z5M3
 FWHM / FWTM 6.0° / 16.0°
 Efficiency 94 %
 Peak intensity 3.8 cd/lm
 LEDs/each optic 1
 Light colour/type White
 Required components:

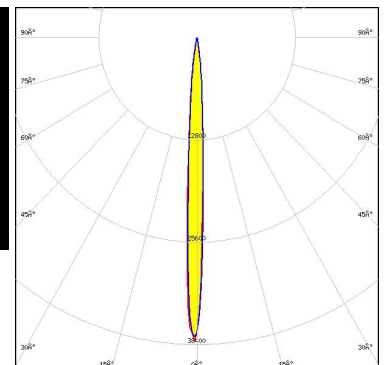

Light distribution files

OPTICAL RESULTS (SIMULATED):



LED XE-G
 FWHM / FWTM 4.0° / 8.0°
 Efficiency 94 %
 Peak intensity 141.3 cd/lm
 LEDs/each optic 1
 Light colour/type White
 Required components:

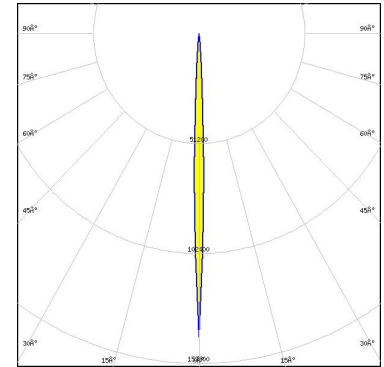

Light distribution files



LED XHP50.3 HI
 FWHM / FWTM 10.0 + 8.0° / 18.0°
 Efficiency 97 %
 Peak intensity 27.4 cd/lm
 LEDs/each optic 1
 Light colour/type White
 Required components:

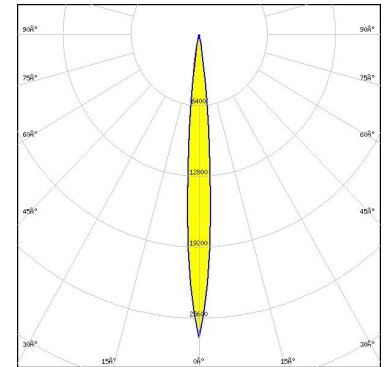

Light distribution files



LED XHP70.2
 FWHM / FWTM 16.0° / 30.0°
 Efficiency 95 %
 Peak intensity 9 cd/lm
 LEDs/each optic 1
 Light colour/type White
 Required components:

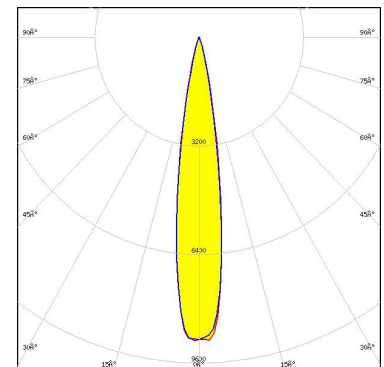

Light distribution files

OPTICAL RESULTS (SIMULATED):



LED XP-G3
 FWHM / FWTM 6.0° / 14.0°
 Efficiency 95 %
 Peak intensity 52.3 cd/lm
 LEDs/each optic 1
 Light colour/type White
 Required components:

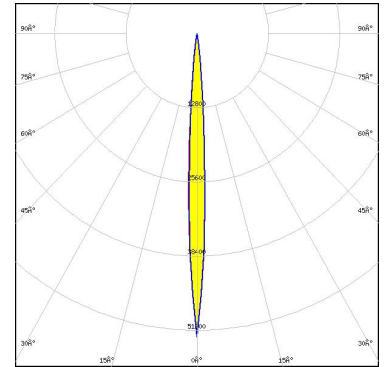

Light distribution files



LED XP-G4 HI
 FWHM / FWTM 6.0° / 12.0°
 Efficiency 96 %
 Peak intensity 75.4 cd/lm
 LEDs/each optic 1
 Light colour/type White
 Required components:

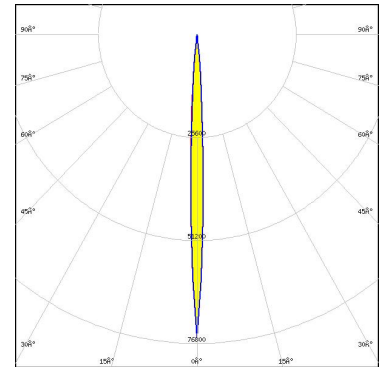

Light distribution files



LED XP-L HI
 FWHM / FWTM 5.6° / 12.0°
 Efficiency 94 %
 Peak intensity 70.2 cd/lm
 LEDs/each optic 1
 Light colour/type White
 Required components:

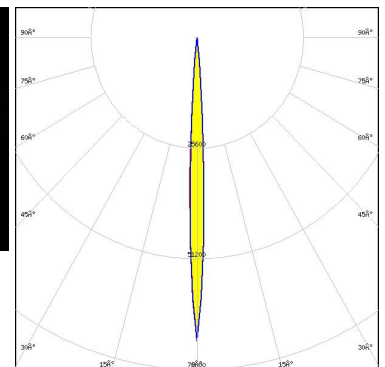

Light distribution files

OPTICAL RESULTS (SIMULATED):



LED XP-P
 FWHM / FWTM 4.0° / 10.0°
 Efficiency 95 %
 Peak intensity 115.4 cd/lm
 LEDs/each optic 1
 Light colour/type White
 Required components:

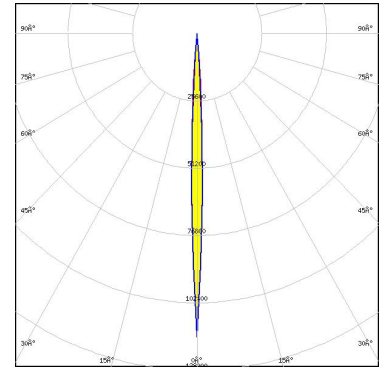

Light distribution files



LED XQ-E HI
 FWHM / FWTM 4.5° / 10.0°
 Efficiency 95 %
 Peak intensity 106.7 cd/lm
 LEDs/each optic 1
 Light colour/type White
 Required components:

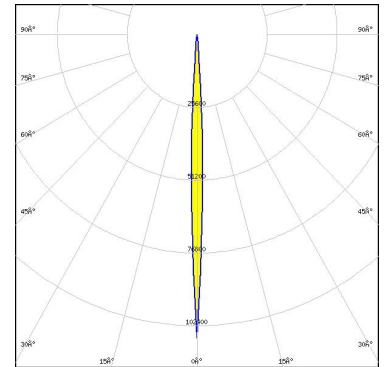

Light distribution files



LED LUXEON C
 FWHM / FWTM 4.0° / 10.0°
 Efficiency 91 %
 Peak intensity 109.6 cd/lm
 LEDs/each optic 1
 Light colour/type White
 Required components:

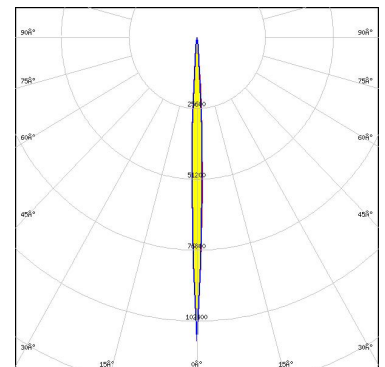

Light distribution files

OPTICAL RESULTS (SIMULATED):



LED LUXEON CZ
FWHM / FWTM 4.0° / 8.0°
Efficiency 93 %
Peak intensity 181 cd/lm
LEDs/each optic 1
Light colour/type White
Required components:

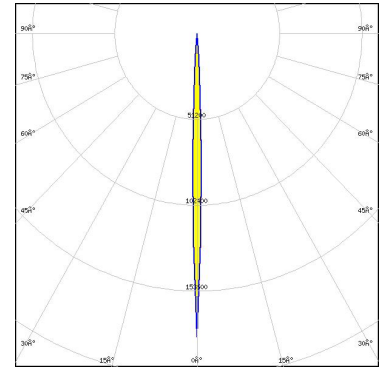

Light distribution files



LED LUXEON HL2X
FWHM / FWTM 6.0° / 14.0°
Efficiency 95 %
Peak intensity 52.6 cd/lm
LEDs/each optic 1
Light colour/type White
Required components:

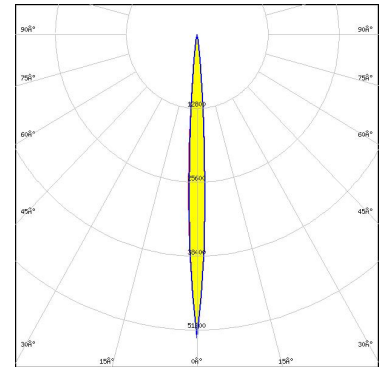

Light distribution files



LED LUXEON HL2Z
FWHM / FWTM 4.0° / 12.0°
Efficiency 96 %
Peak intensity 78.5 cd/lm
LEDs/each optic 1
Light colour/type White
Required components:

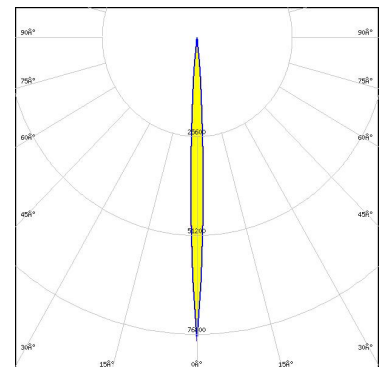

Light distribution files

OPTICAL RESULTS (SIMULATED):



LED LUXEON HL4X
FWHM / FWTM 8.0° / 16.0°
Efficiency 97 %
Peak intensity 33 cd/lm
LEDs/each optic 1
Light colour/type White
Required components:

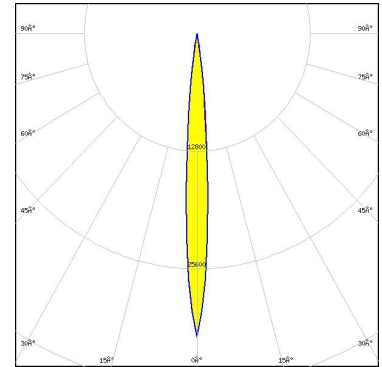

Light distribution files



LED LUXEON HL4Z
FWHM / FWTM 6.0° / 14.0 + 13.0°
Efficiency 96 %
Peak intensity 56.4 cd/lm
LEDs/each optic 1
Light colour/type White
Required components:

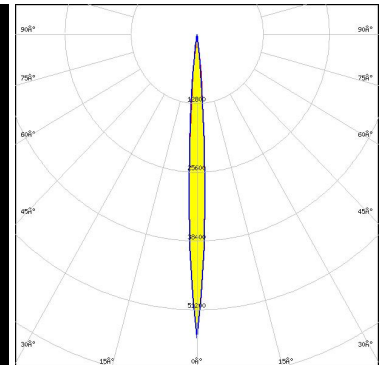
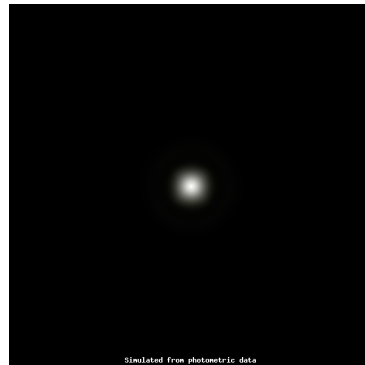

Light distribution files



LED LUXEON Rebel Plus
FWHM / FWTM 6.0° / 10.0°
Efficiency 95 %
Peak intensity 84.3 cd/lm
LEDs/each optic 1
Light colour/type White
Required components:

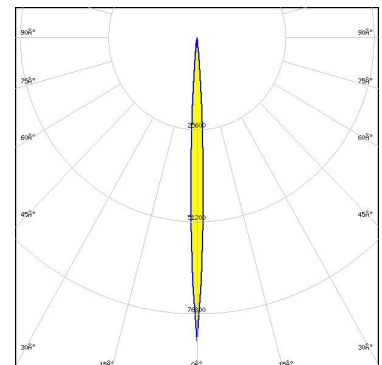

Light distribution files

OPTICAL RESULTS (SIMULATED):



LED LUXEON Rubix
FWHM / FWTM 4.0° / 10.0°
Efficiency 95 %
Peak intensity 114.3 cd/lm
LEDs/each optic 1
Light colour/type Green
Required components:

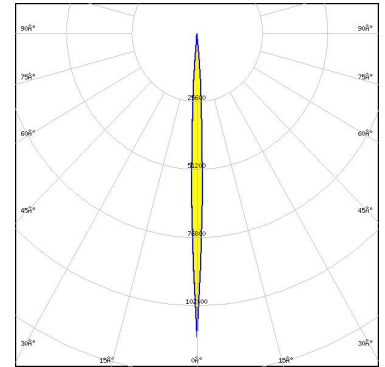

Light distribution files



LED LUXEON Rubix
FWHM / FWTM 4.0° / 10.0°
Efficiency 95 %
Peak intensity 106.8 cd/lm
LEDs/each optic 1
Light colour/type White
Required components:

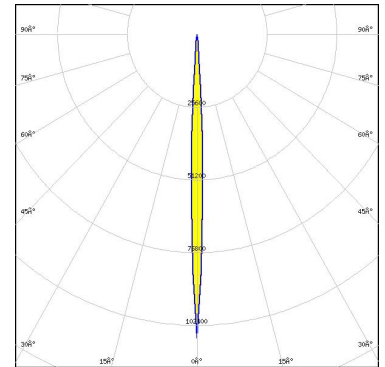

Light distribution files



LED LUXEON Rubix
FWHM / FWTM 4.0° / 10.0°
Efficiency 95 %
Peak intensity 114 cd/lm
LEDs/each optic 1
Light colour/type Blue
Required components:

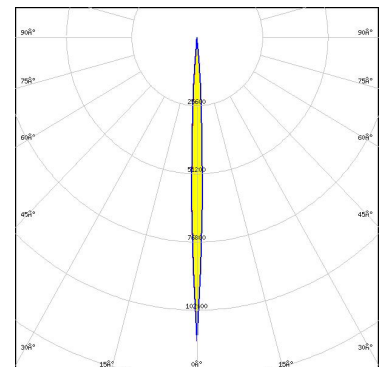

Light distribution files

OPTICAL RESULTS (SIMULATED):



LED LUXEON Rubix
 FWHM / FWTM 4.0° / 10.0°
 Efficiency 95 %
 Peak intensity 119.4 cd/lm
 LEDs/each optic 1
 Light colour/type Red
 Required components:

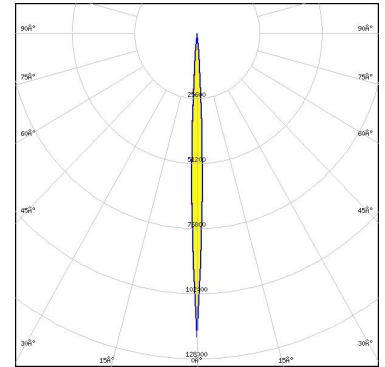

Light distribution files



LED LUXEON Rubix
 FWHM / FWTM 10.0° / 17.0°
 Efficiency 97 %
 Peak intensity 26.8 cd/lm
 LEDs/each optic 4
 Light colour/type RGBW
 Required components:

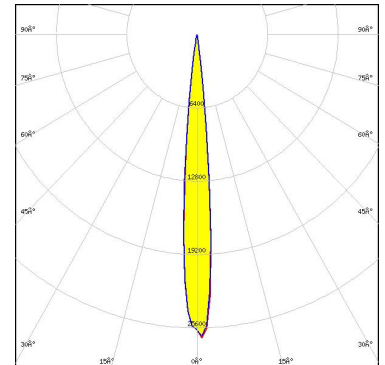
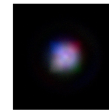
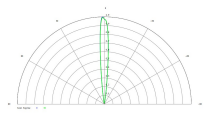

Light distribution files



LED LUXEON V
 FWHM / FWTM 8.0° / 17.0°
 Efficiency 95 %
 Peak intensity 30.9 cd/lm
 LEDs/each optic 1
 Light colour/type White
 Required components:

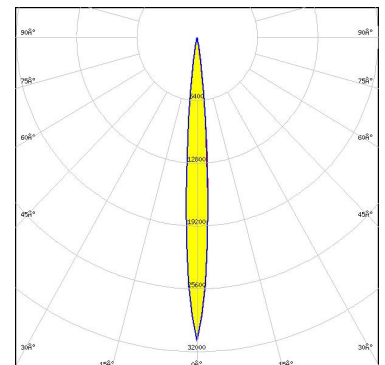

Light distribution files

OPTICAL RESULTS (SIMULATED):

LUMINUS

LED	SBT-90
FWHM / FWTM	8.0° / 18.0°
Efficiency	97 %
Peak intensity	33.1 cd/lm
LEDs/each optic	1
Light colour/type	White
Required components:	



Light distribution files

LUMINUS

LED	SFT-40 Gen2
FWHM / FWTM	6.0° / 12.0 + 10.0°
Efficiency	96 %
Peak intensity	80.2 cd/lm
LEDs/each optic	1
Light colour/type	White
Required components:	

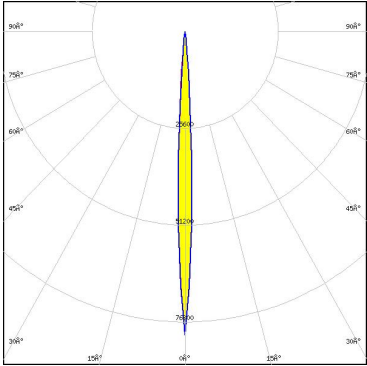
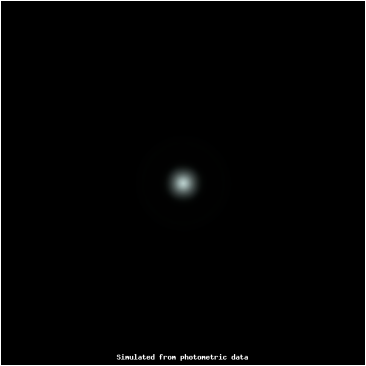
Light distribution files

LUMINUS

LED	SFT-40-WCS
FWHM / FWTM	6.0° / 12.0°
Efficiency	96 %
Peak intensity	74.7 cd/lm
LEDs/each optic	1
Light colour/type	White
Required components:	

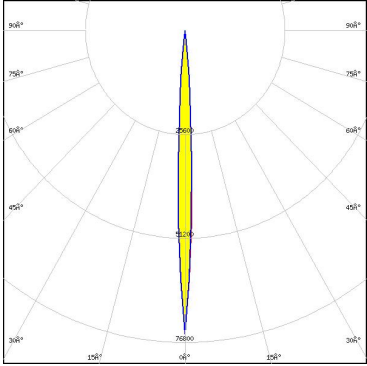

Light distribution files

OPTICAL RESULTS (SIMULATED):



LED SFT-70X-WCS
 FWHM / FWTM 6.0° / 14.0°
 Efficiency 97 %
 Peak intensity 49.1 cd/m
 LEDs/each optic 1
 Light colour/type White
 Required components:

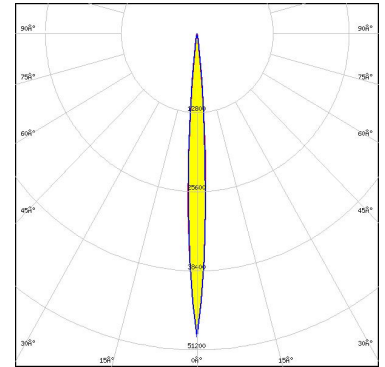

Light distribution files



LED SST-25-W
 FWHM / FWTM 6.0° / 12.0°
 Efficiency 96 %
 Peak intensity 62.1 cd/m
 LEDs/each optic 1
 Light colour/type White
 Required components:

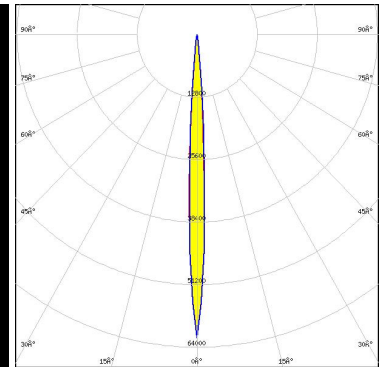
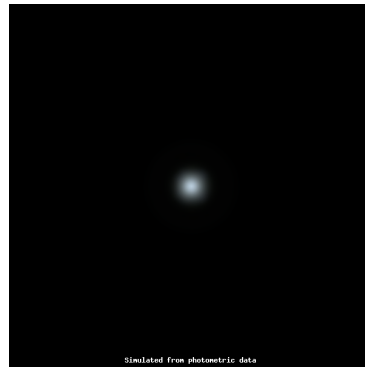

Light distribution files



LED SST-40
 FWHM / FWTM 8.0° / 16.0°
 Efficiency 97 %
 Peak intensity 31.7 cd/m
 LEDs/each optic 1
 Light colour/type White
 Required components:

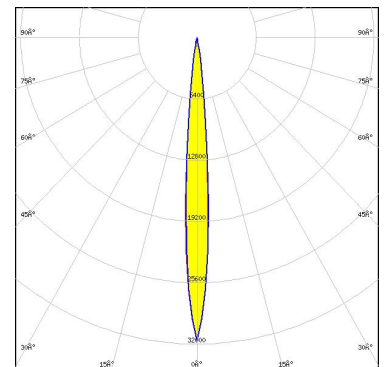

Light distribution files

OPTICAL RESULTS (SIMULATED):

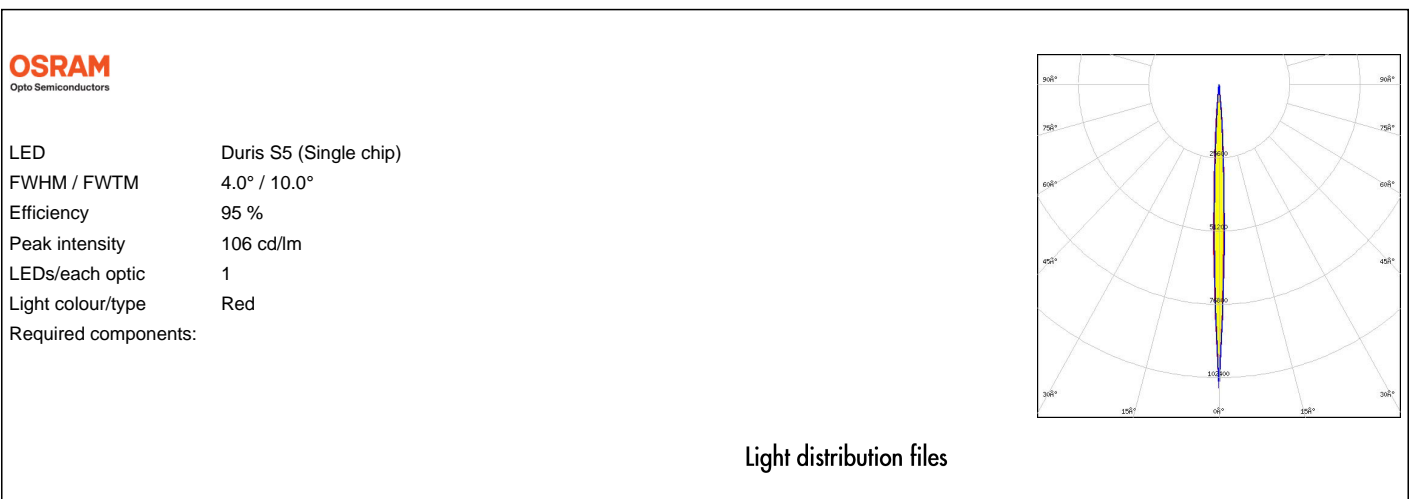
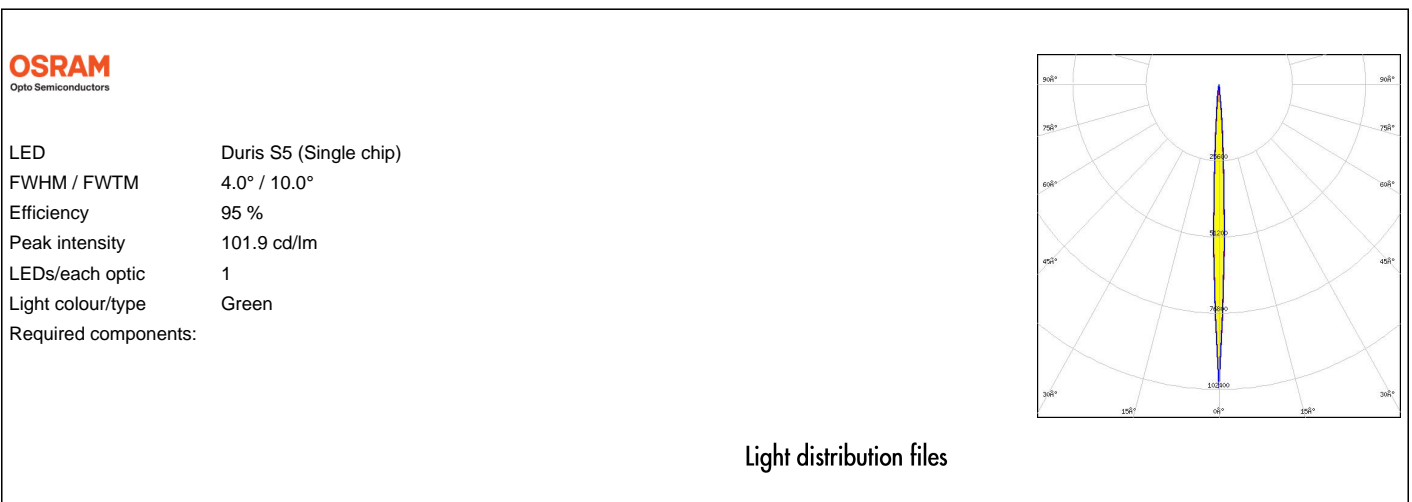
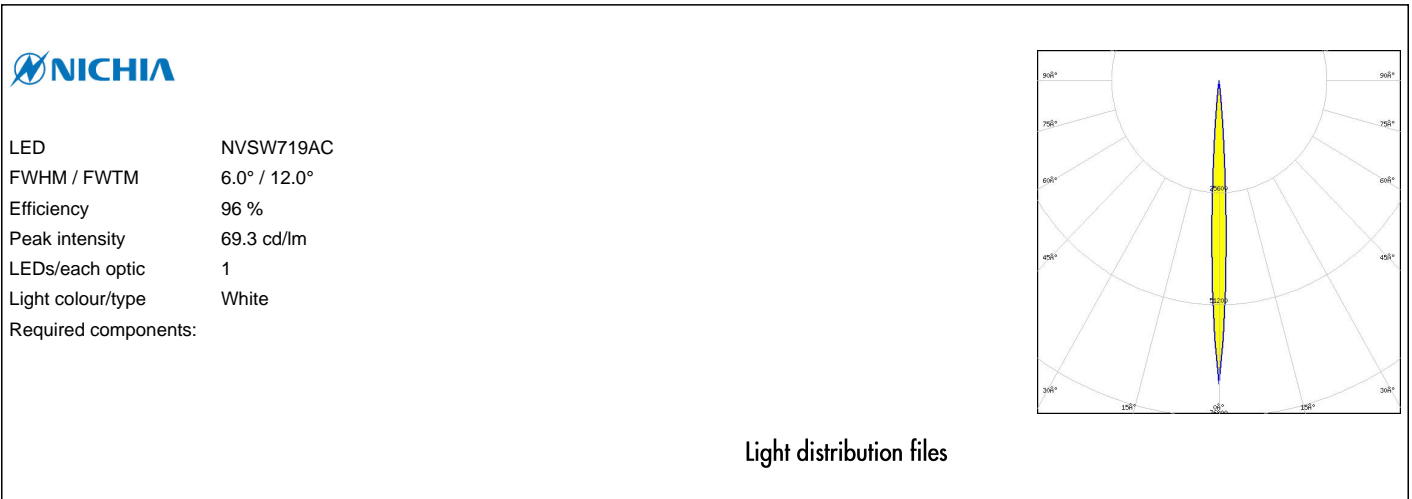

OPTICAL RESULTS (SIMULATED):

OSRAM
Opto Semiconductors

LED OSLON Pure 1414
 FWHM / FWTM 4.0° / 10.0°
 Efficiency 95 %
 Peak intensity 111.4 cd/lm
 LEDs/each optic 1
 Light colour/type White
 Required components:

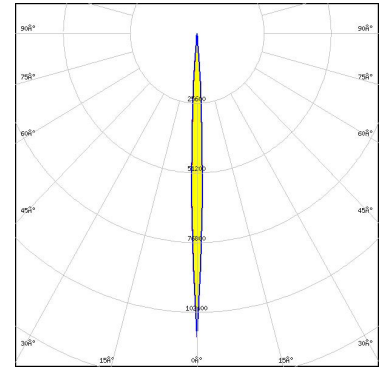

Light distribution files

OSRAM
Opto Semiconductors

LED OSTAR Projection Compact (KW.CSLNM1.TG)
 FWHM / FWTM 4.0° / 8.0°
 Efficiency 94 %
 Peak intensity 139.7 cd/lm
 LEDs/each optic 1
 Light colour/type White
 Required components:

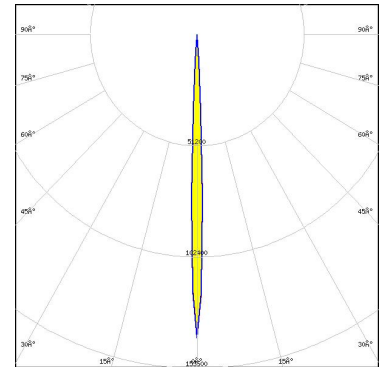

Light distribution files

OSRAM
Opto Semiconductors

LED SFH 4717AS
 FWHM / FWTM 6.7° / 14.5°
 Efficiency 94 %
 Peak intensity 46.5 cd/lm
 LEDs/each optic 1
 Light colour/type White
 Required components:

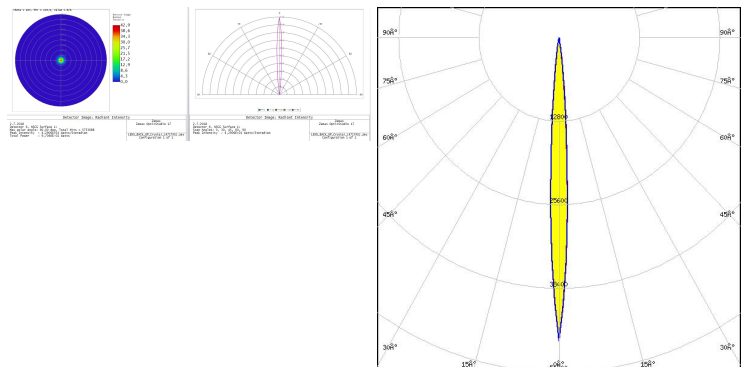

Light distribution files

OPTICAL RESULTS (SIMULATED):

OSRAM
Opto Semiconductors

LED SFH 4727AS
FWHM / FWTM 6.7° / 14.5°
Efficiency 94 %
Peak intensity 47 cd/lm
LEDs/each optic 1
Light colour/type White
Required components:

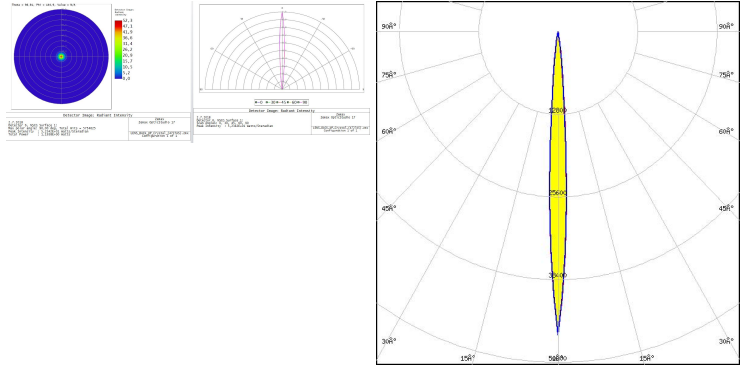

Light distribution files

SAMSUNG

LED LH351B
FWHM / FWTM 6.0° / 14.0°
Efficiency 96 %
Peak intensity 54.7 cd/lm
LEDs/each optic 1
Light colour/type White
Required components:

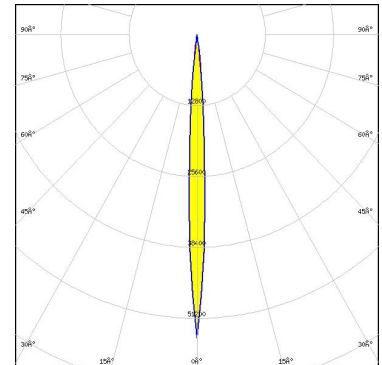

Light distribution files

SAMSUNG

LED LH351C
FWHM / FWTM 6.0° / 14.0°
Efficiency 96 %
Peak intensity 47.7 cd/lm
LEDs/each optic 1
Light colour/type White
Required components:

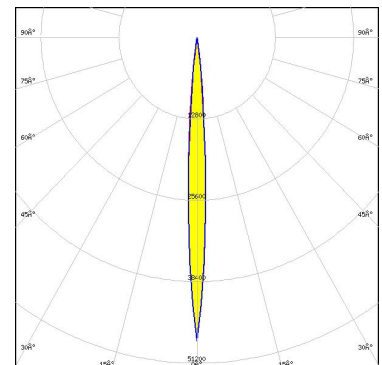

Light distribution files

OPTICAL RESULTS (SIMULATED):

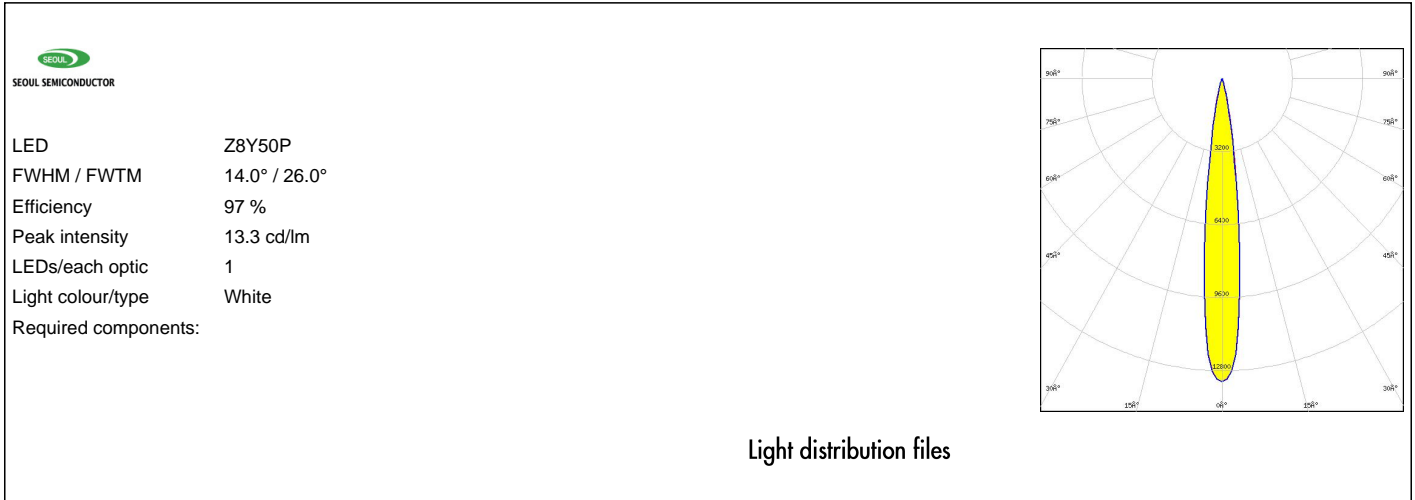

GENERAL INFORMATION:

NOTE: The typical beam angle will be changed by different color, chip size and chip position tolerance. The typical total beam angle is the full angle measured where the luminous intensity is half of the peak value.

MATERIALS:

As part of our continuous research and improvement processes, and to ensure the best possible quality and availability of our products, LEDiL reserves the right to change material grades without notice.

PRODUCT DATA USER AGREEMENT AND DISCLAIMER:

The measured data in the provided downloadable LEDiL Product Datasheets and Mechanical 2D-Drawings is rounded and provided as reference for planning. LEDiL Oy's optical specifications have been verified by conducting performance testing of the products in accordance with the company's quality system. The reported data are averaged results of multiple measurements with typical variation. LEDiL Oy reserves the right to without prior notification make changes and improvements to its products.

LEDiL Oy assumes neither warranty, nor guarantee nor any other liability of any kind for the contents and correctness of the provided data. The provided data has been generated with highest diligence but the provided data may in reality not represent the complete possible variation range of all intrinsic parameters. Therefore, in certain cases a deviation from the provided data could occur.

LEDiL Oy reserves the right to undertake technical changes of its products without further notification which could lead to changes in the provided data. LEDiL Oy assumes no liability of any kind for the possible deviation from any provided data or any other damage resulting from the usage of the provided data.

The user agrees to this disclaimer and user agreement with the download or usage of the provided files.

LEDiL Oy

Joensuunkatu 7
FI-24240 SALO
Finland

LEDiL Inc.

228 West Page Street
Suite D
Sycamore IL 60178
USA

Ledil Optics Technology (Shenzhen) Co., Ltd.

405 , Block B
Casic Motor Building
Shenzhen 518057
P.R.CHINA

Local sales and technical support

[www.ledil.com/
where_to_buy](http://www.ledil.com/where_to_buy)

Shipping locations

Poznan, Poland
Hong Kong, China

Distribution Partners

[www.ledil.com/
where_to_buy](http://www.ledil.com/where_to_buy)